

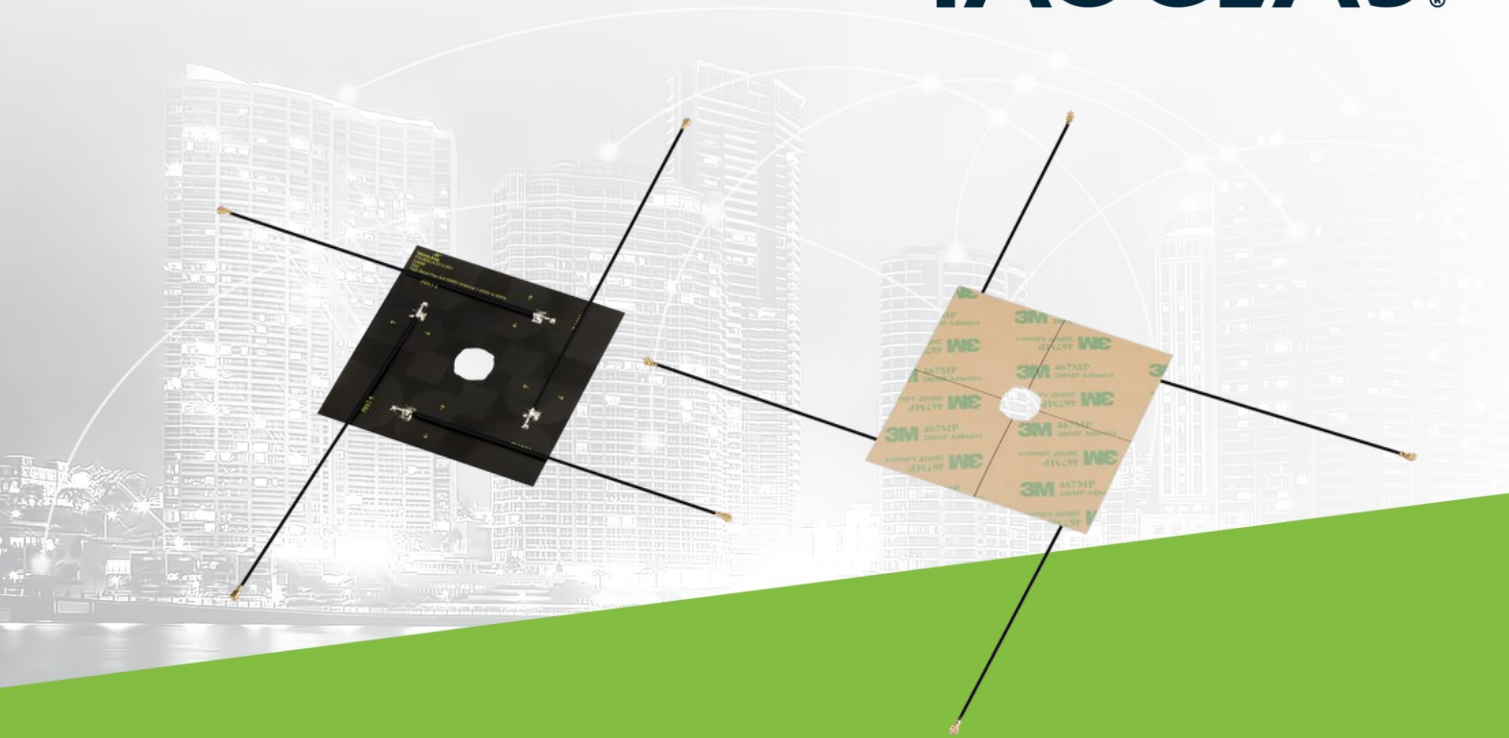

TAOGLAS®



Datasheet

Part No:
FXUB52.A.07.C.001

Description

High Band 4x4 MIMO Flex PCB Antenna covering 1.4 to 6GHz

Features:

Low-profile Flexible Polymer Antenna
4* LTE MIMO Configuration
Covering 1400MHz to 6000MHz
Coaxial Cables: 150mm of 1.37mm
Connectors: I-PEX MHFI(U.FL)
Dims: 90 x 90 x 0.24mm
RoHS & Reach Compliant

1.	Introduction	3
2.	Specification	4
3.	Mechanical Drawing	7
4.	Packaging	8
5.	Antenna Characteristics (Inner)	9
6.	Antenna Characteristics (Outer)	13
7.	Radiation Patterns (Inner)	17
8.	Radiation Patterns (Outer)	46
<hr/>		
	Changelog	75

Taoglas makes no warranties based on the accuracy or completeness of the contents of this document and reserves the right to make changes to specifications and product descriptions at any time without notice. Taoglas reserves all rights to this document and the information contained herein. Reproduction, use or disclosure to third parties without express permission is strictly prohibited.



1. Introduction

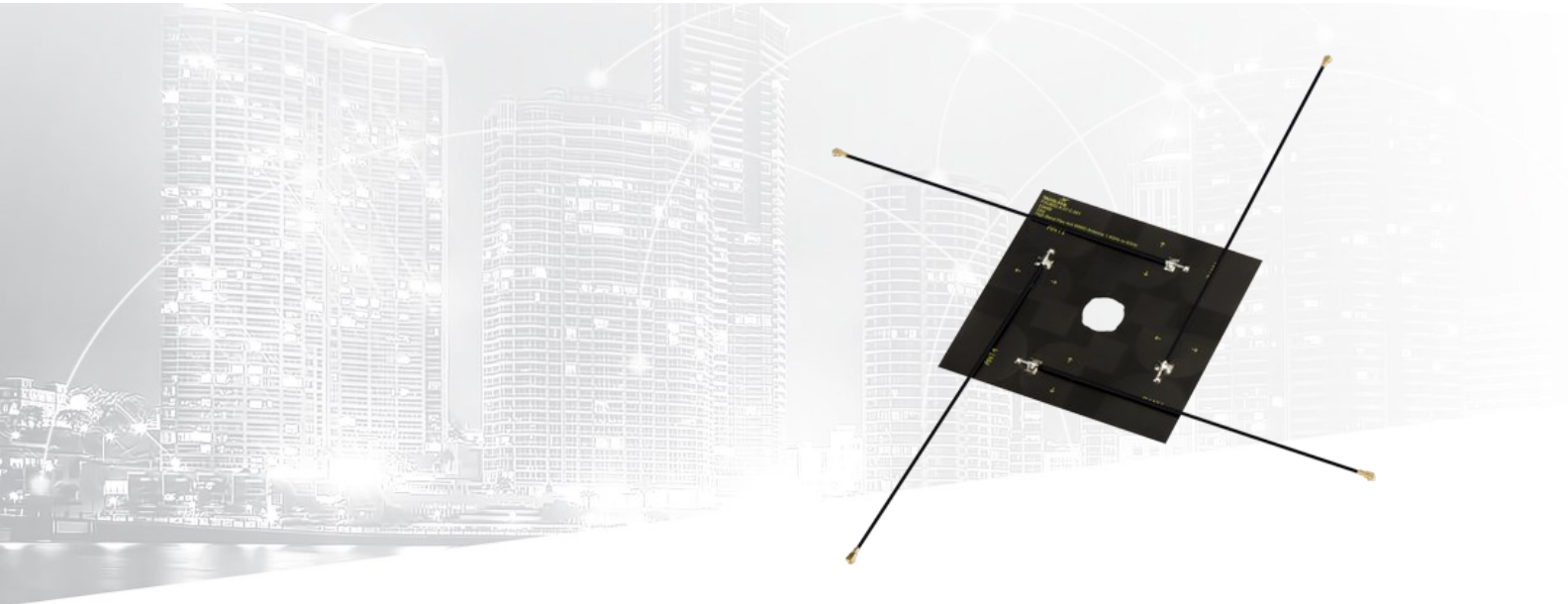

The Taoglas FXUB52 is a flexible wide-band 4x4 MIMO cellular antenna engineered to operate across the 1400MHz-6000MHz frequency spectrum. It encompasses Cellular, 2.4/5.8/7.125GHz Wi-Fi, ISM, and AGPS bands. The high-efficiency antenna is designed for installation flexibility, which is perfect for IoT devices requiring MIMO coverage on the upper cellular bands.

Typical use cases for the FXUB52 MIMO series of antennas include:

- Healthcare and medical devices
- Industrial IoT applications
- Smart home and electronics
- Smart city asset and sensor monitoring
- Connected vehicles and fleet management.
- Energy and environmental monitoring

Key features and specifications of the FXUB52 include:

- **Efficiency and Design:** Exhibits high efficiency across all bands and is ground plane independent. The flexible polymer body measures 90x90x0.2mm, ensuring an ultra-thin form factor.
- **Installation:** Utilizes a simple “peel and stick” installation process via 3M adhesive, adhering securely to non-metal surfaces.
- **High-performance:** Achieves a peak gain of up to 6.29 dBi and an efficiency of up to 81%.
- **Mounting:** The antenna can be mounted directly onto plastic or glass, making it suitable for cost-effective manufacturing and ease-of-assembly in IoT devices.
- **Cable and Connector:** Supplied with 1.37mm micro coax cables and I-PEX MHF1 connectors as standard for straightforward installation. Cables can be routed from the flex PCB or routed through the central aperture, depending on installation requirements. Cables and connectors are customizable to meet specific installation needs.
- **Clearance Requirements:** For optimal radiation efficiency, the antenna should be mounted at least 10mm away from metal components or surfaces, with 20mm being ideal.

For more information on the FXUB52 antenna or to request samples, reach out to your local customer services team or visit www.taoglas.com.

2. Specification

LTE Electrical (Inner)									
Band	Frequency (MHz)	Measurement	Efficiency (%)	Average Gain (dB)	Peak Gain (dBi)	Impedance	Polarization	Radiation Pattern	Max. input power
LTE/5G NR Band 11,21,255	1427-1661	Antenna 1	63.5	-1.97	4.49	50 Ω	Linear	Omni	5W
		Antenna 2	63.9	-1.95	2.83				
		Antenna 3	63.7	-1.96	4.55				
		Antenna 4	65.1	-1.87	4.02				
LTE/5G NR Band 1,2,3,4,25,37,66,70	1695-2200	Antenna 1	67.1	-1.73	4.82				
		Antenna 2	66.6	-1.77	3.47				
		Antenna 3	75.5	-1.22	5.37				
		Antenna 4	67.2	-1.73	3.69				
LTE/5G NR Band 30,40	2300-2400	Antenna 1	75.2	-1.24	3.65				
		Antenna 2	76.4	-1.17	4.33				
		Antenna 3	70.8	-1.50	3.71				
		Antenna 4	81.5	-0.89	3.62				
LTE/5G NR Band 7,41,53	2484-2690	Antenna 1	74.2	-1.30	3.48				
		Antenna 2	76.5	-1.16	4.50				
		Antenna 3	75.4	-1.23	4.84				
		Antenna 4	79.0	-1.03	5.12				
LTE/5G NR Band 42,43,53	3300-4200	Antenna 1	80.1	-0.96	6.16				
		Antenna 2	81.1	-0.91	5.70				
		Antenna 3	76.4	-1.17	6.09				
		Antenna 4	76.2	-1.18	4.84				
LTE/5G NR	4400-5000	Antenna 1	66.5	-1.77	5.92				
		Antenna 2	66.3	-1.79	5.99				
		Antenna 3	72.9	-1.38	6.61				
		Antenna 4	60.5	-2.18	5.27				
LTE/5G NR Band 46,47	5150-5925	Antenna 1	72.5	-1.40	6.29				
		Antenna 2	73.1	-1.36	5.74				
		Antenna 3	69.9	-1.55	5.71				
		Antenna 4	72.4	-1.40	5.52				

LTE Electrical (Outer)									
Band	Frequency (MHz)	Measurement	Efficiency (%)	Average Gain (dB)	Peak Gain (dBi)	Impedance	Polarization	Radiation Pattern	Max. input power
LTE Band 11,21	1427-1661	Antenna 1	71.6	-1.45	3.75	50 Ω	Linear	Omni	5W
		Antenna 2	70.2	-1.54	3.15				
		Antenna 3	71.1	-1.48	3.39				
		Antenna 4	70.0	-1.55	3.66				
LTE Band 1,2,3,4,25,37,66,70	1695-2200	Antenna 1	66.9	-1.74	4.18				
		Antenna 2	69.2	-1.60	3.47				
		Antenna 3	66.6	-1.76	3.65				
		Antenna 4	64.4	-1.91	3.82				
LTE Band 30,40	2300-2400	Antenna 1	73.5	-1.34	3.23				
		Antenna 2	71.2	-1.48	3.39				
		Antenna 3	71.4	-1.46	3.15				
		Antenna 4	71.8	-1.44	3.44				
LTE Band 7,41,53	2484-2690	Antenna 1	71.4	-1.47	3.70				
		Antenna 2	70.2	-1.54	3.56				
		Antenna 3	69.3	-1.60	3.62				
		Antenna 4	69.2	-1.60	3.41				
5GNR Band 42,43,53	3300-4200	Antenna 1	74.3	-1.29	4.76				
		Antenna 2	73.9	-1.31	4.18				
		Antenna 3	74.6	-1.27	4.41				
		Antenna 4	72.4	-1.40	4.42				
Wi-Fi	4400-5000	Antenna 1	55.4	-2.56	4.51				
		Antenna 2	59.0	-2.29	4.66				
		Antenna 3	56.8	-2.46	4.78				
		Antenna 4	56.5	-2.48	4.56				
LTE Band 46,47	5150-5925	Antenna 1	69.8	-1.56	6.20				
		Antenna 2	68.3	-1.66	5.17				
		Antenna 3	71.6	-1.45	5.39				
		Antenna 4	69.5	-1.58	6.03				

Mechanical	
Dimensions	90x90x0.24mm
Weight	12g
Material	Flexible Polymer
Connector	IPEX U.FL
Cable	4 x 150mm 1.37 Coaxial

Environmental	
Operation Temperature	-40°C to 85°C
Storage Temperature	-40°C to 85°C
RoHs & REACH Compliant	Yes

3. Mechanical Drawing

ISO NO.: EDW.002192

STATE: Released

NOTES:

- No dregs or insufficient soldering. Solder thickness 0.2 ~1.7mm
- The solder must be smooth and full to the edges of the pad. The solder must not extend outside of the pad area.
- The connector position has special orientation to the PCB as per drawing.
- All material must be RoHS compliant.
- Open/short QC: VSWR required.
- Soldered area.

REV	ZONE	DESCRIPTION	ENG	APPROVED	DATE
D05	All	Initial release	N.Hunt	I.Mendez	4/3/2024

High Band Flex 4x4 MIMO Antenna 1.4GHz to 6GHz

(SOLDER AREAS 4x)

DETAIL A SCALE 2 : 1

DETAIL B SCALE 2 : 1

ITEM NO.	DESCRIPTION	QTY.
1	High Band Flex 4x4 MIMO Antenna, 1.4GHz to 6GHz	1
2	150mm, 1.37mm coax, IPEX U.FL to 2/3/4	4

APPROVED BY: I.Mendez	<p>TAOGLAS TW Design Centre</p> <p><small>The drawing & Taoglas Confidential information and its inherent design concepts are property of Taoglas. This is not to be copied or shared with third parties without the prior written consent of Taoglas.</small></p>
CHECK BY: N.Baird	
DRAWN BY: N.Hunt	
DATE: 4/3/2024	
<p>TITLE : High Band Flex 4x4 MIMO Antenna 1.4GHz to 6GHz with 150mm 1.37 IPEX MHFI(U.FL)</p> <p>PART NO. : FXUB52.A.07.C.001</p>	
<p>UNLESS OTHERWISE SPECIFIED DIMENSIONS ARE REFERENCE ONLY</p>	
THIRD ANGLE PROJECTION	<p>UNIT: mm SCALE: 1:1 PAGES: 1/1 REV: D05</p>

4. Packaging

100pcs FXUB52.A.07.C.001 per PE Bag
 Dimensions – 280x320mm
 Weight – 0.12Kg



1000pcs FXUB52.A.07.C.001 per carton
 Dimensions – 360x310x160mm
 Weight - 2Kg

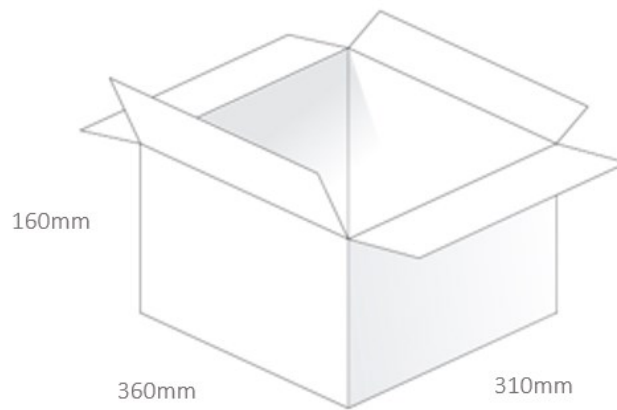

5. Antenna Characteristics (Inner)

The following outlines the antenna characteristics for the FXUB52.A.07.C.001, with cables routed through the centre hole of the antenna, as shown in the test setup image below. This configuration is denoted as 'Inner'.

5.1 Test Setup

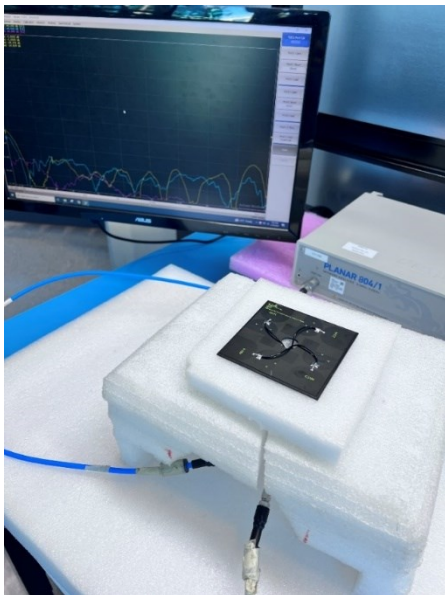
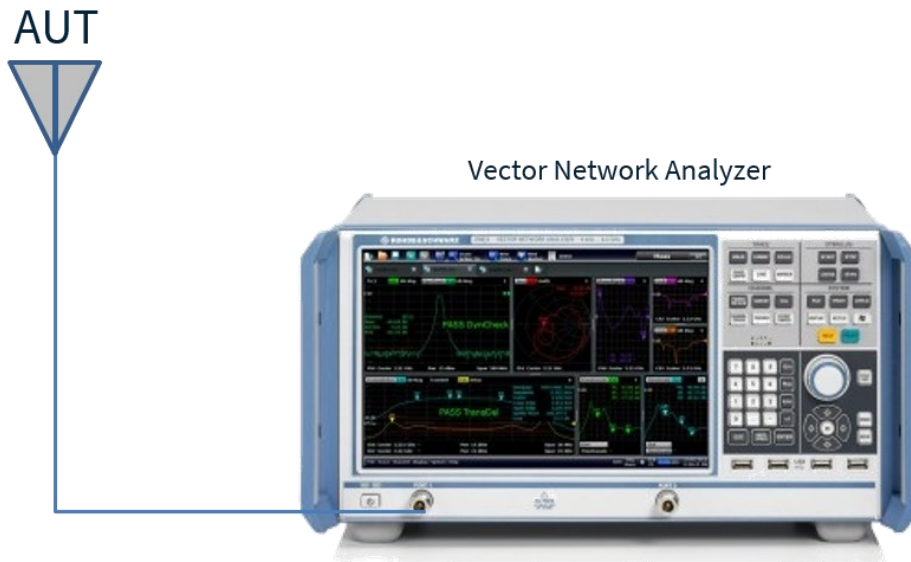

VNA Set-up with cables going through the center of the Antenna

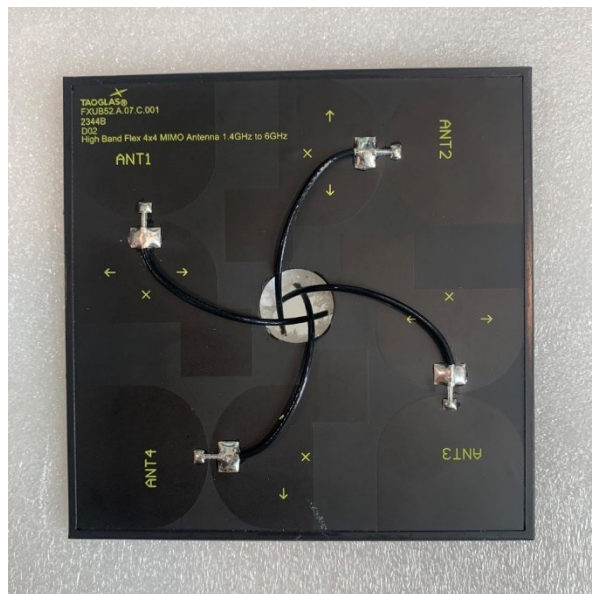

A close up to show the cable routing for the 'Inner' set-up

5.2 Return Loss

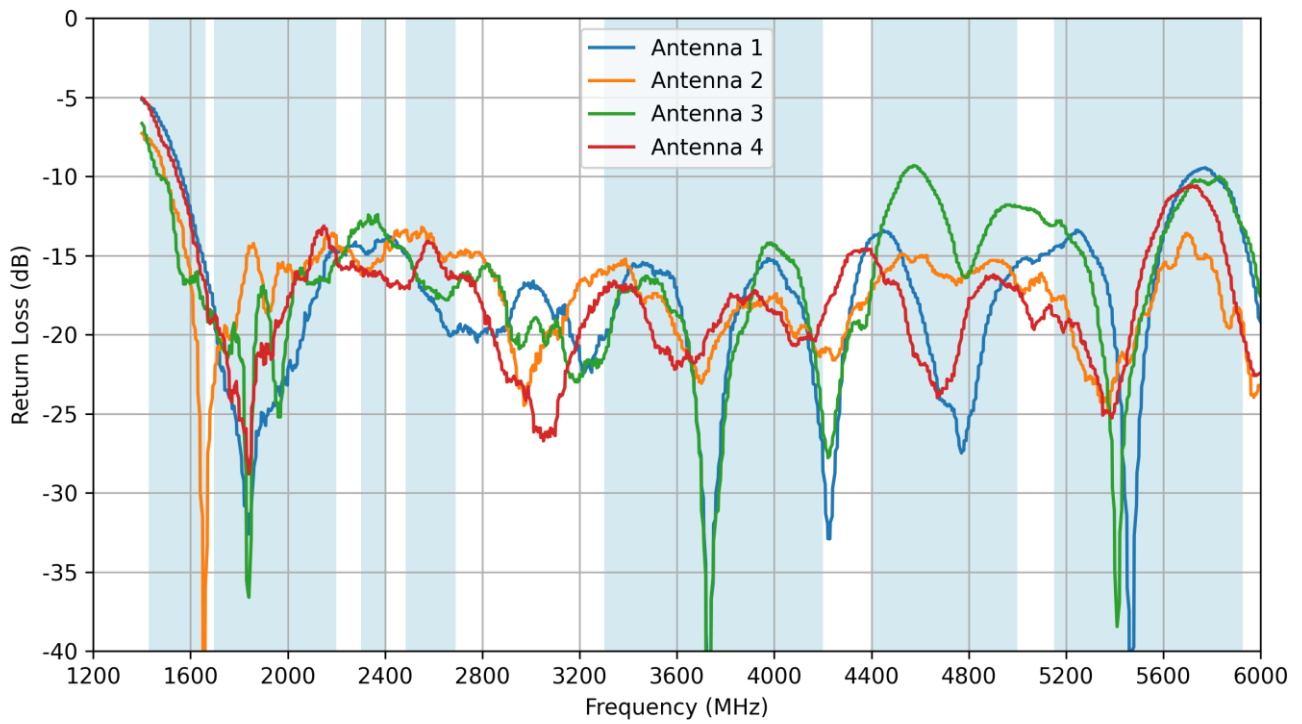

5.3 Isolation

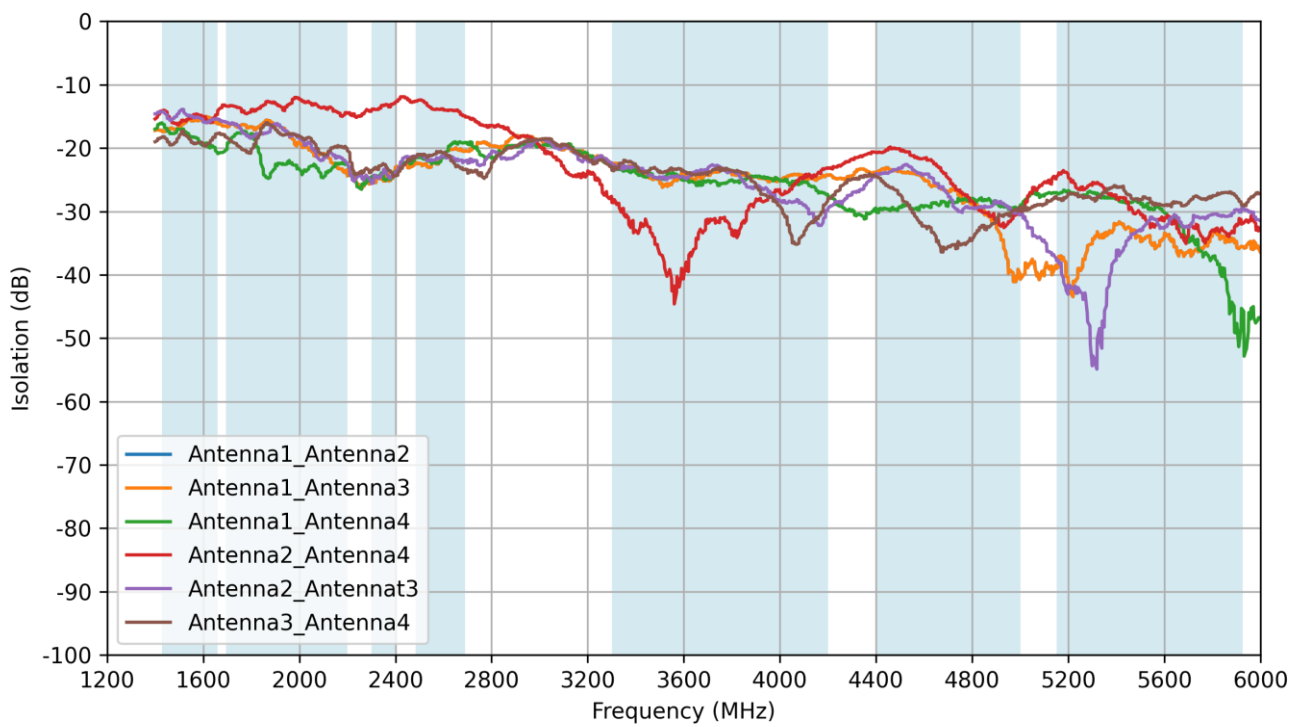

5.4 Efficiency

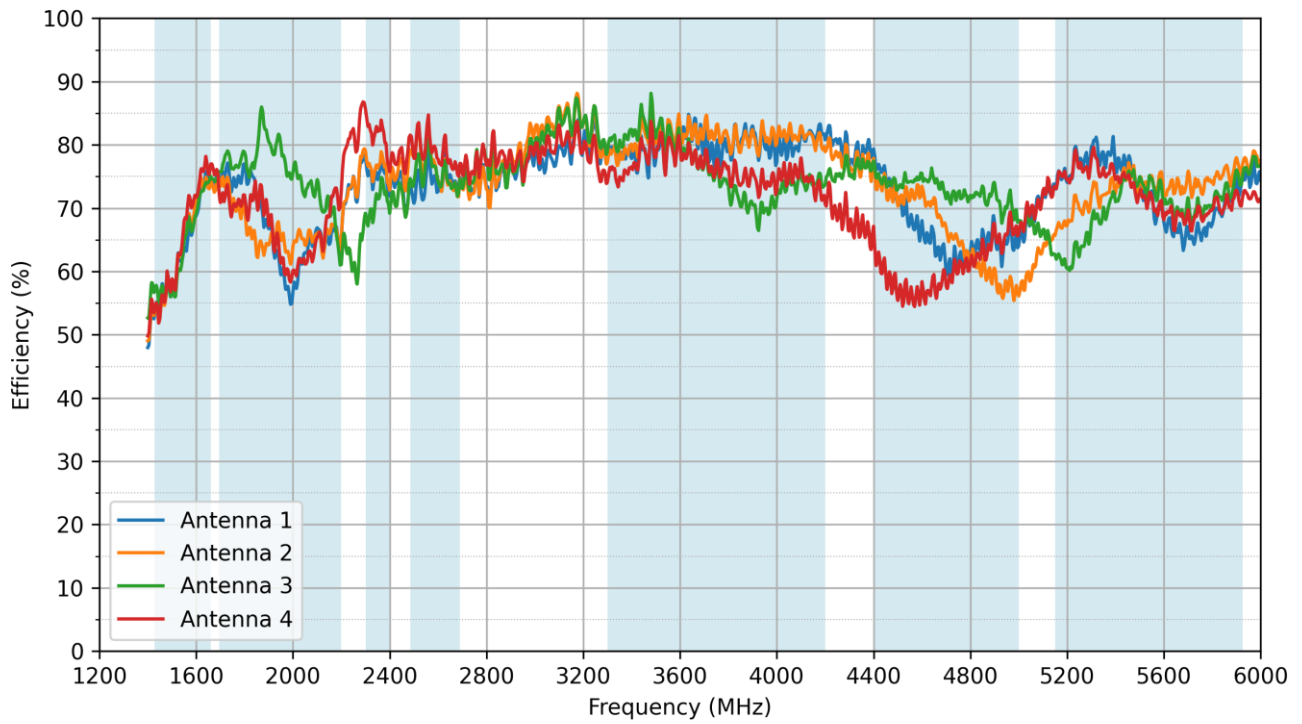

5.5 Average Gain

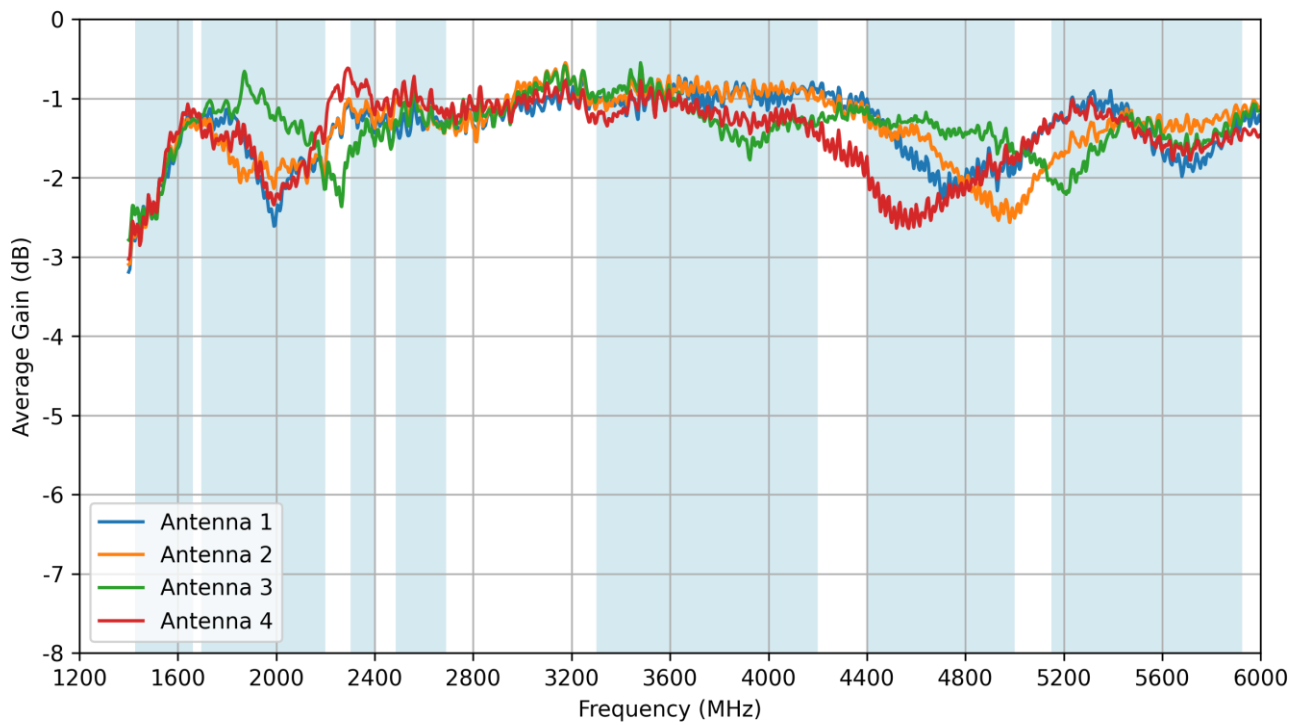

5.6 Peak Gain (Gtotal)

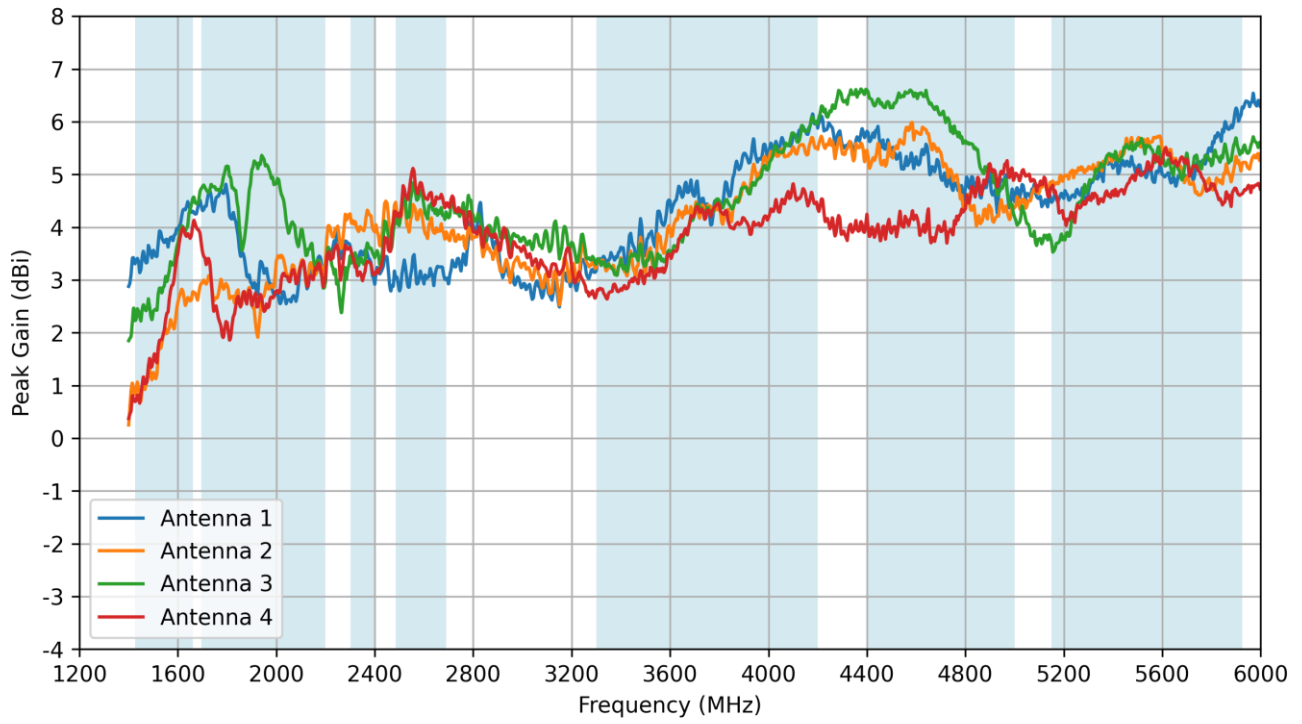

6. Antenna Characteristics (Outer)

The following outlines the antenna characteristics for the FXUB52.A.07.C.001, with cables routed outward away from the antenna, as shown in the test setup image below. This configuration is denoted as 'Outer'.

6.1 Test Setup

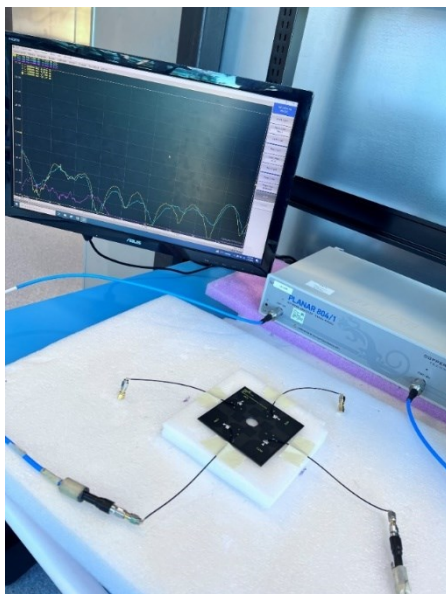
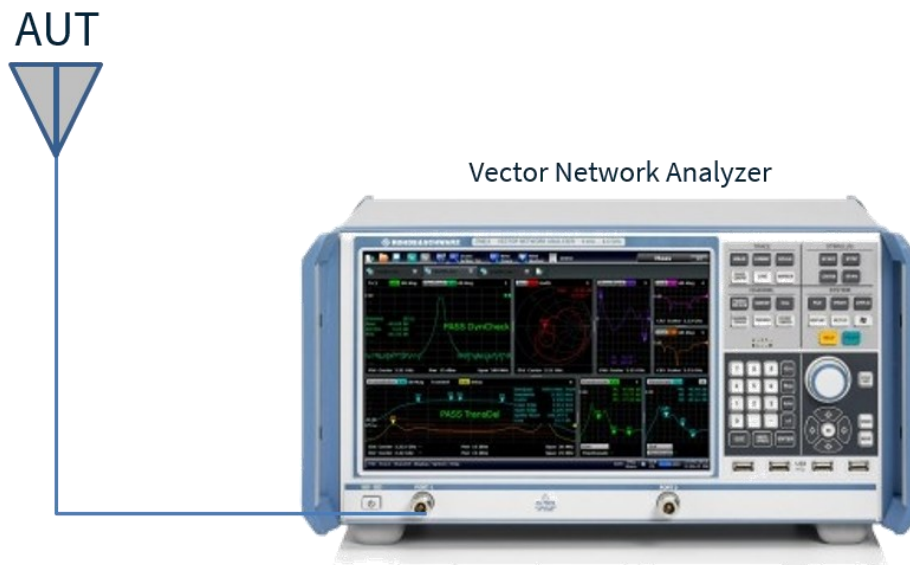

VNA Set-up with cables going Outward away from the Antenna

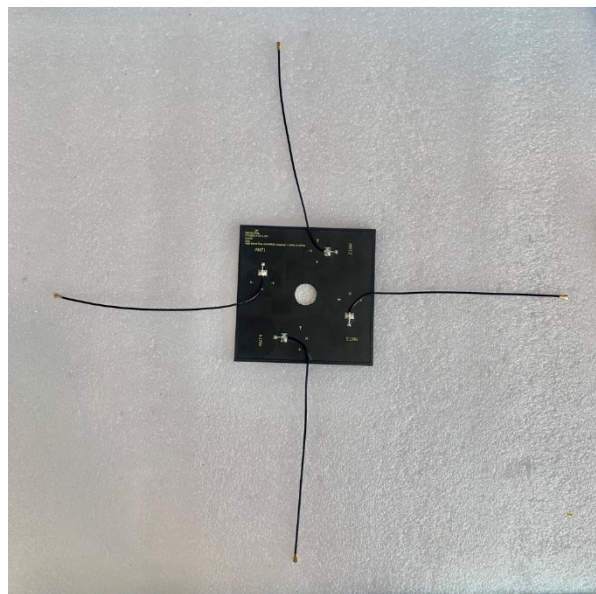

A close up to show the cable routing for the 'Outer' set-up

6.2 Return Loss

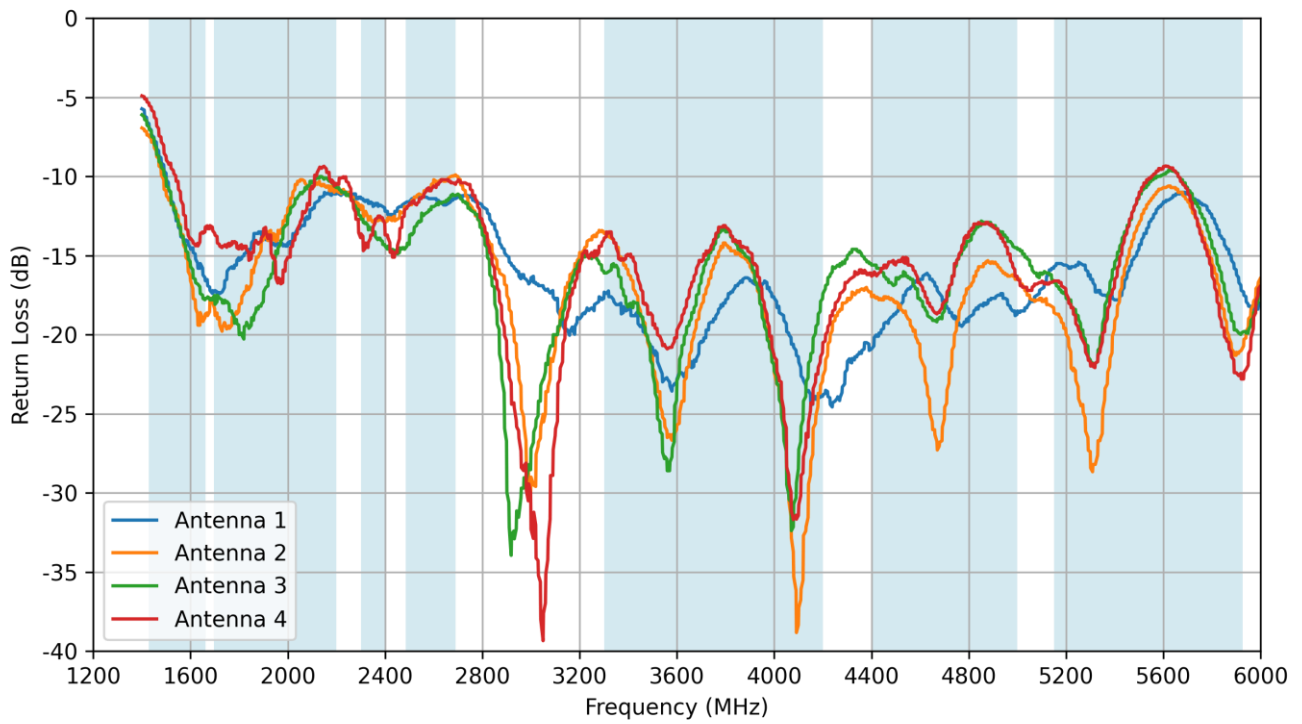

6.3 Isolation

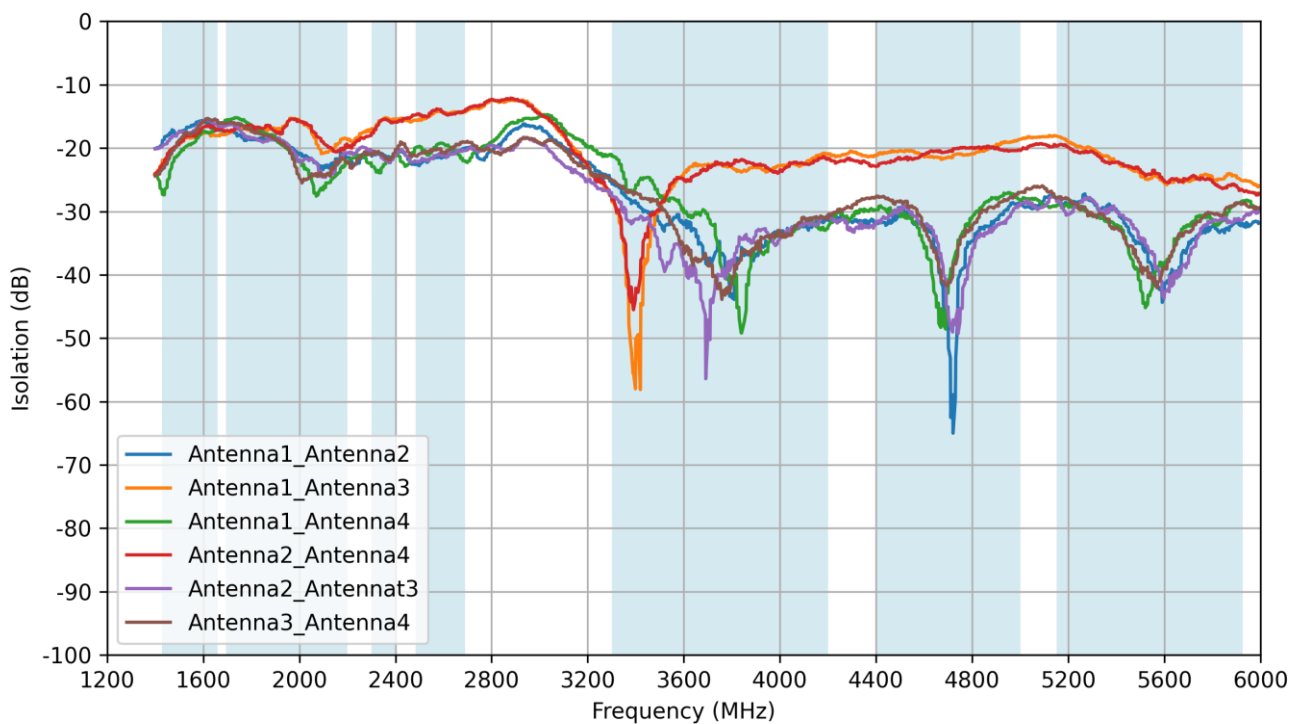

6.4 Efficiency

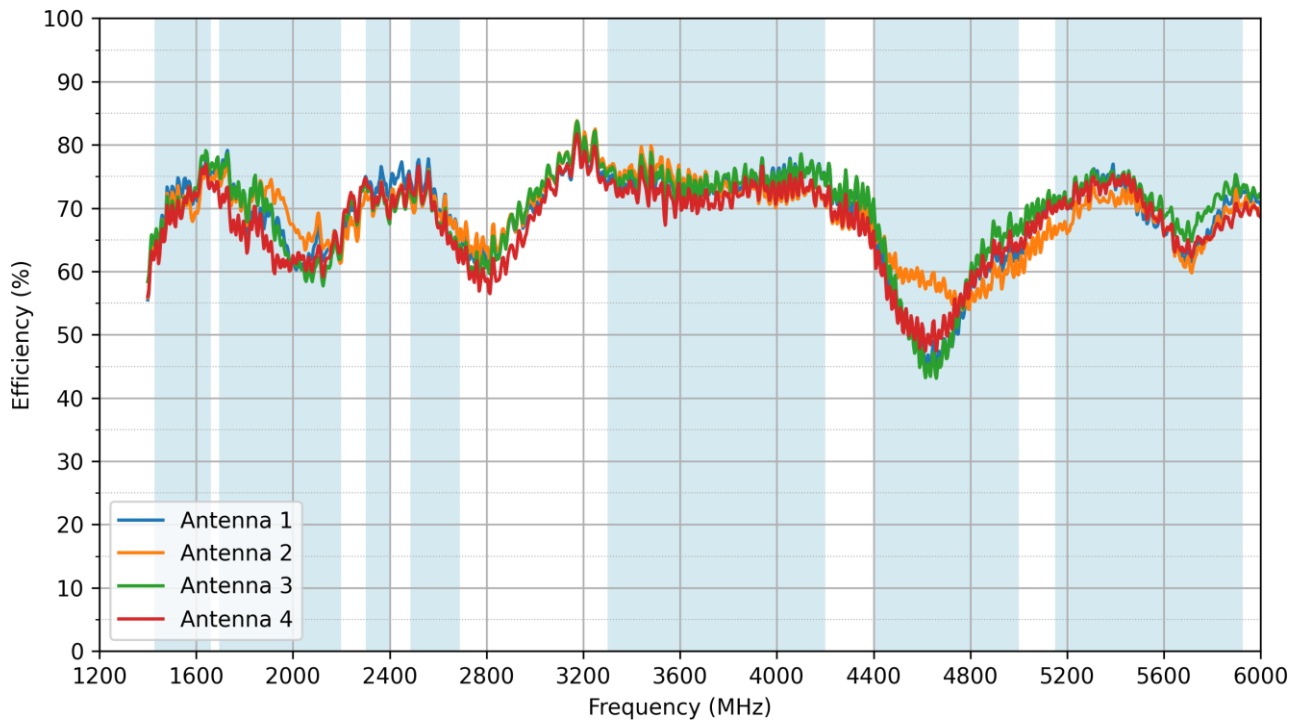

6.5 Average Gain

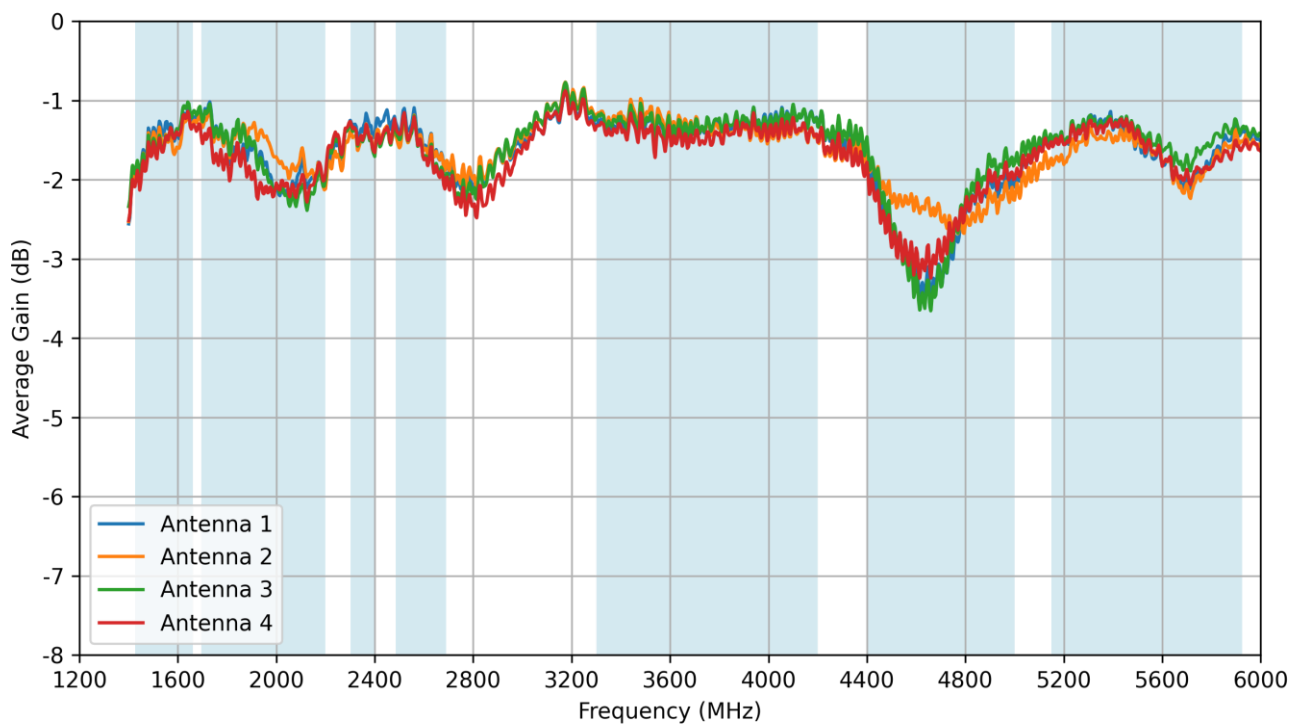

6.6 Peak Gain (Gtotal)

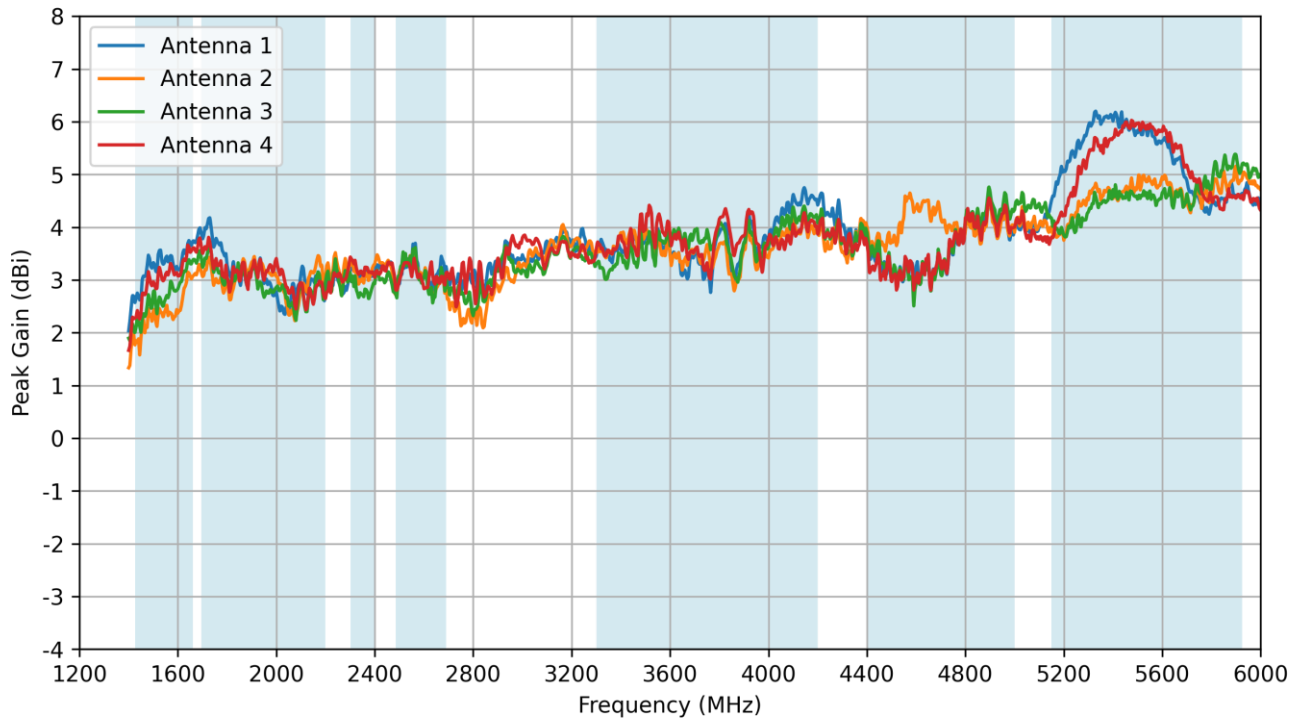

7. Radiation Patterns (Inner)

7.1 Test Setup

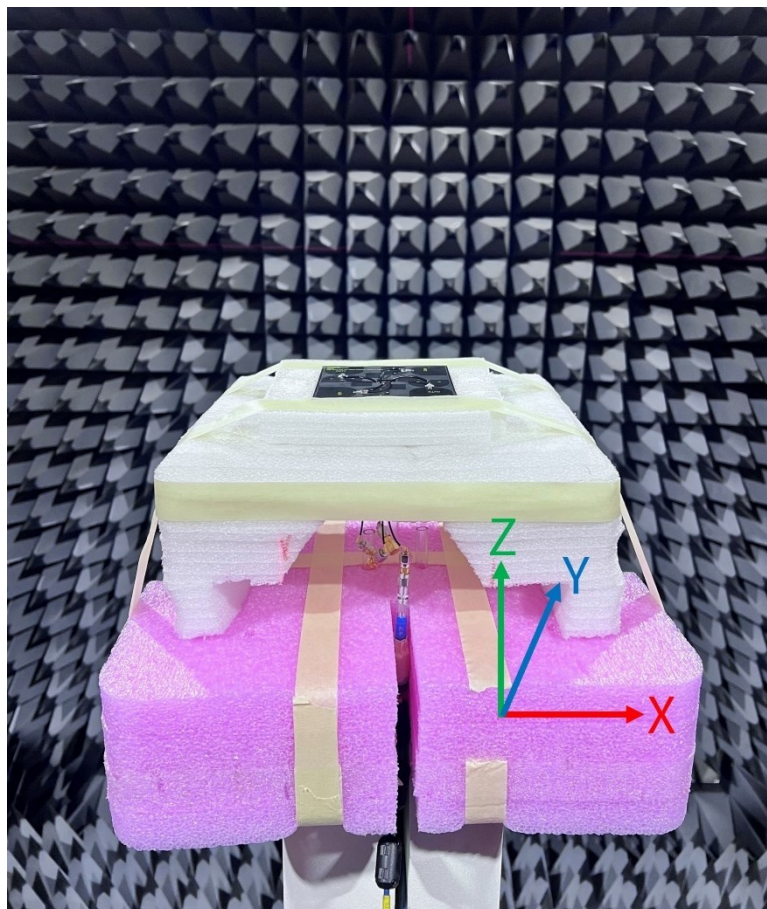
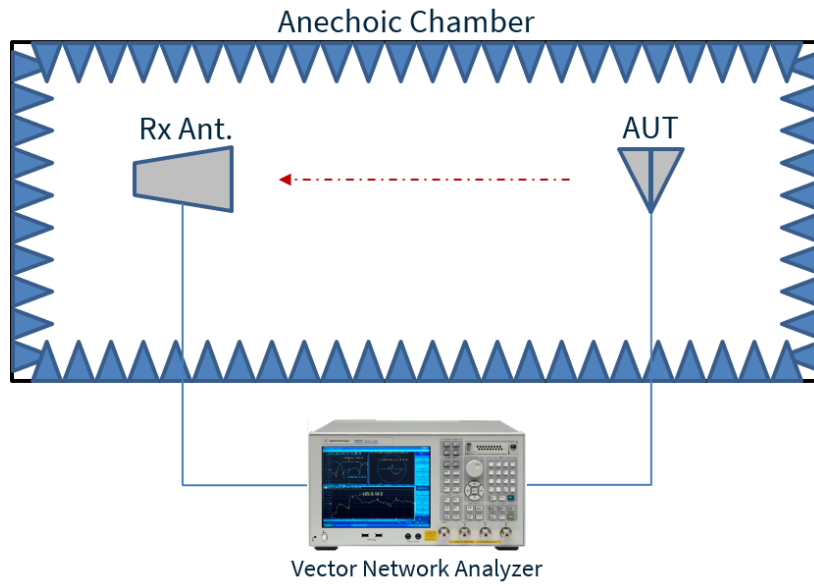

Chamber Set-up with cables going through the centre of the Antenna

7.2 LTE Antenna 1 Patterns at 1545 MHz

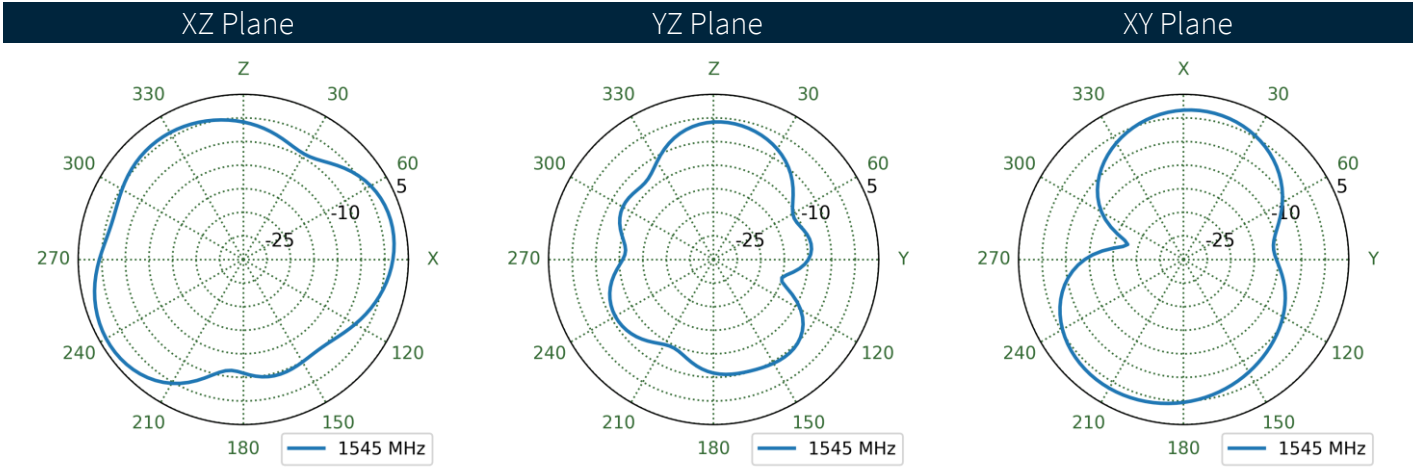
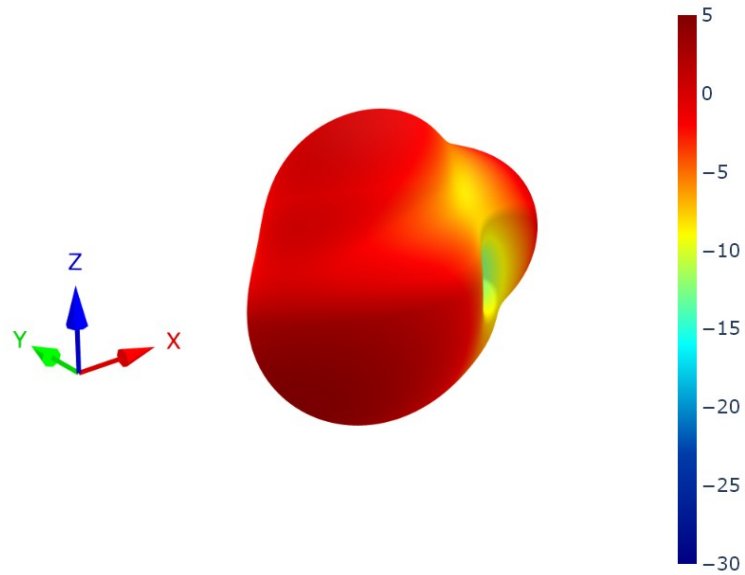

7.3 LTE Antenna 2 Patterns at 1545 MHz

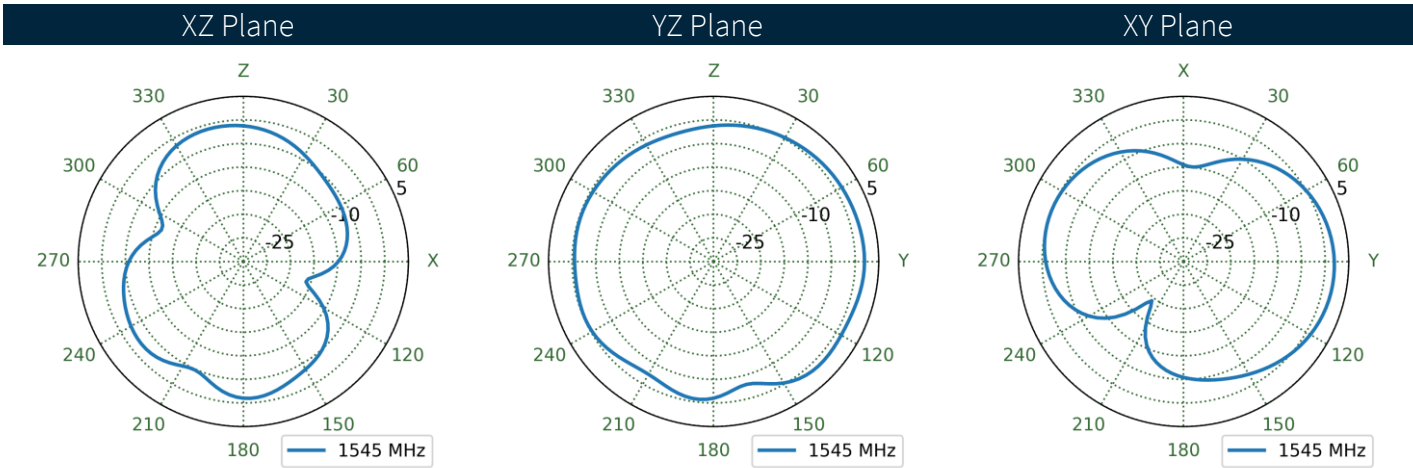
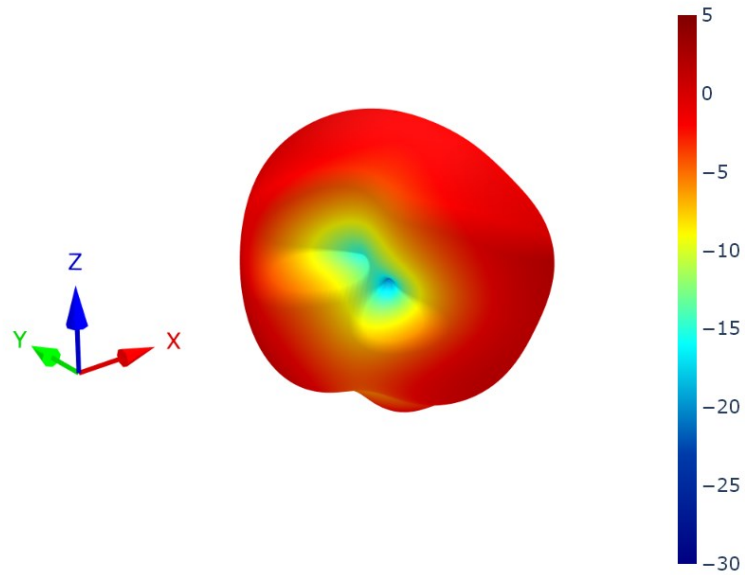

7.4 LTE Antenna 3 Patterns at 1545 MHz

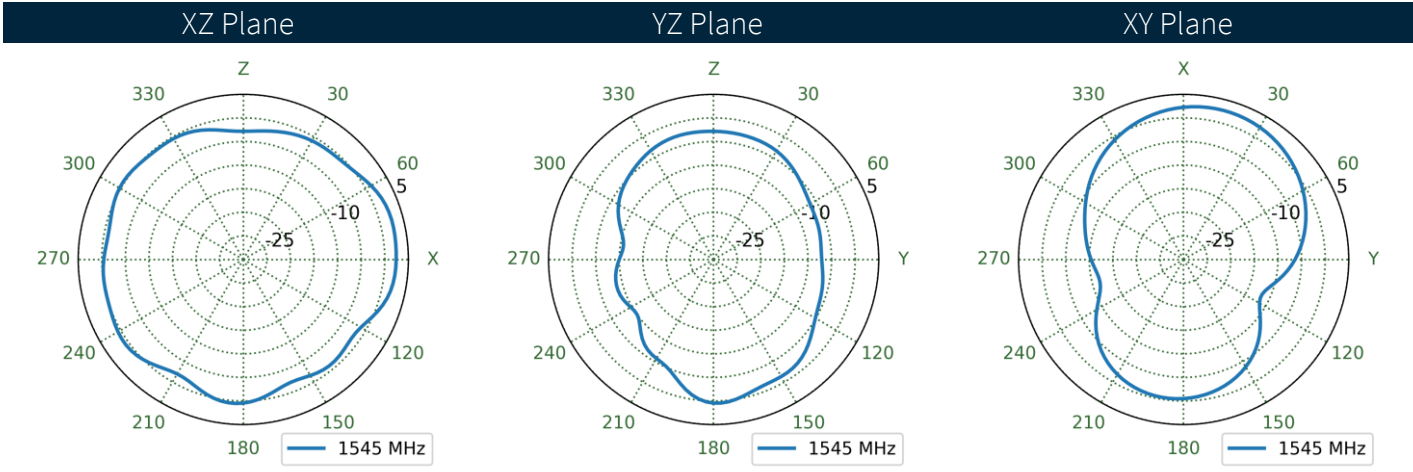
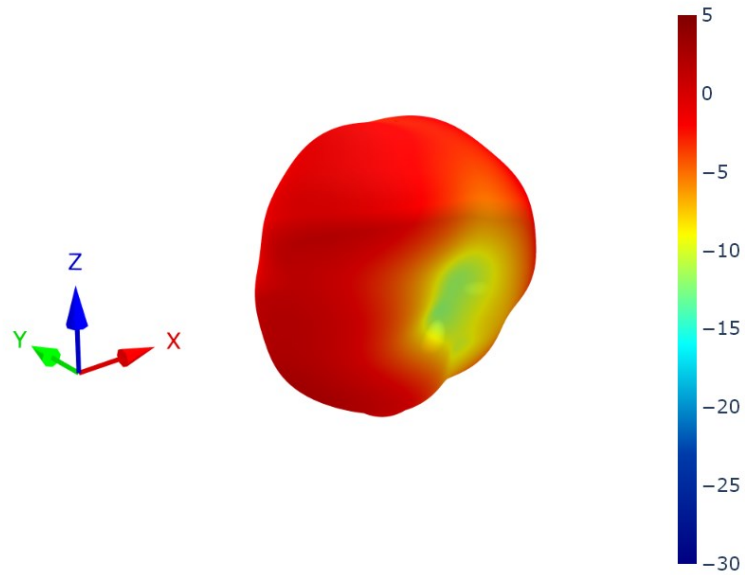

7.5 LTE Antenna 4 Patterns at 1545 MHz

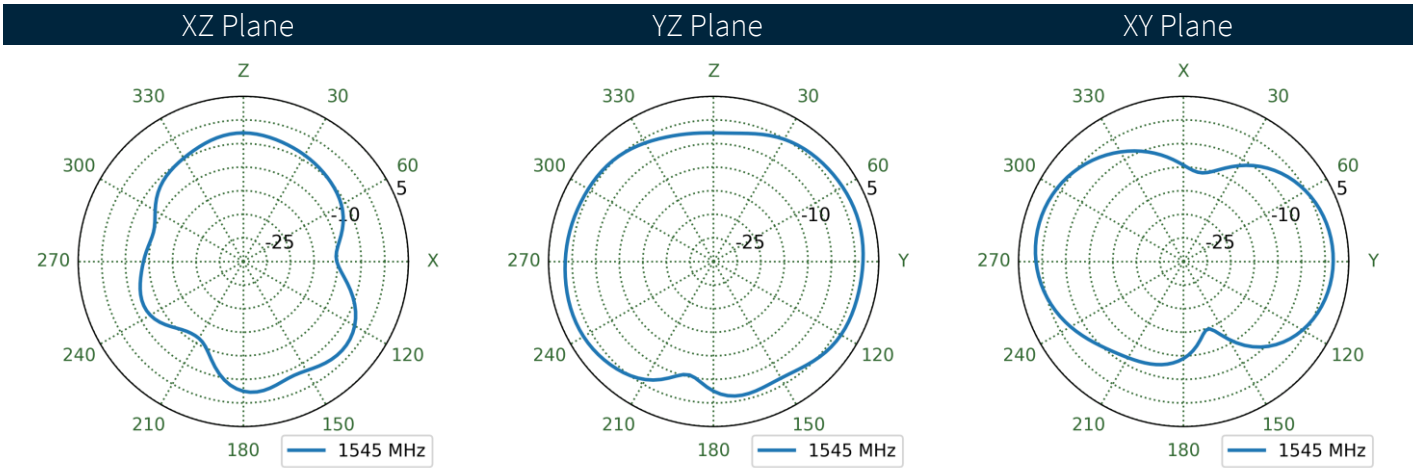
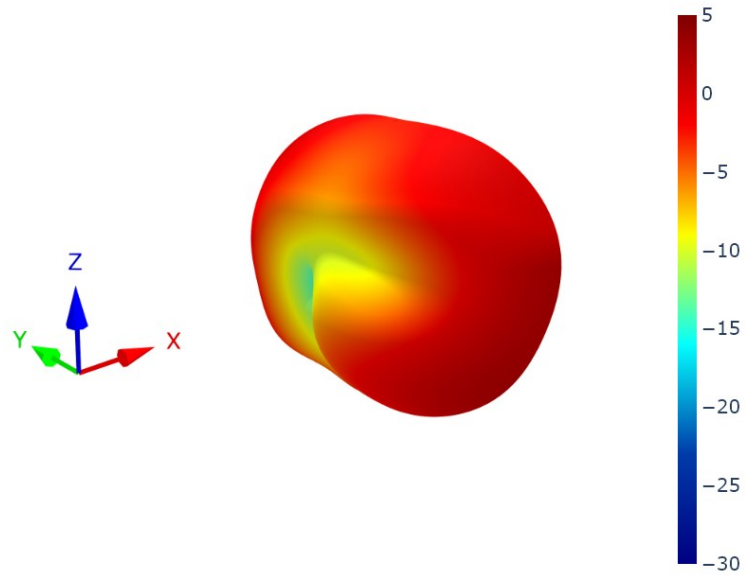

7.6 LTE Antenna 1 Patterns at 1950 MHz

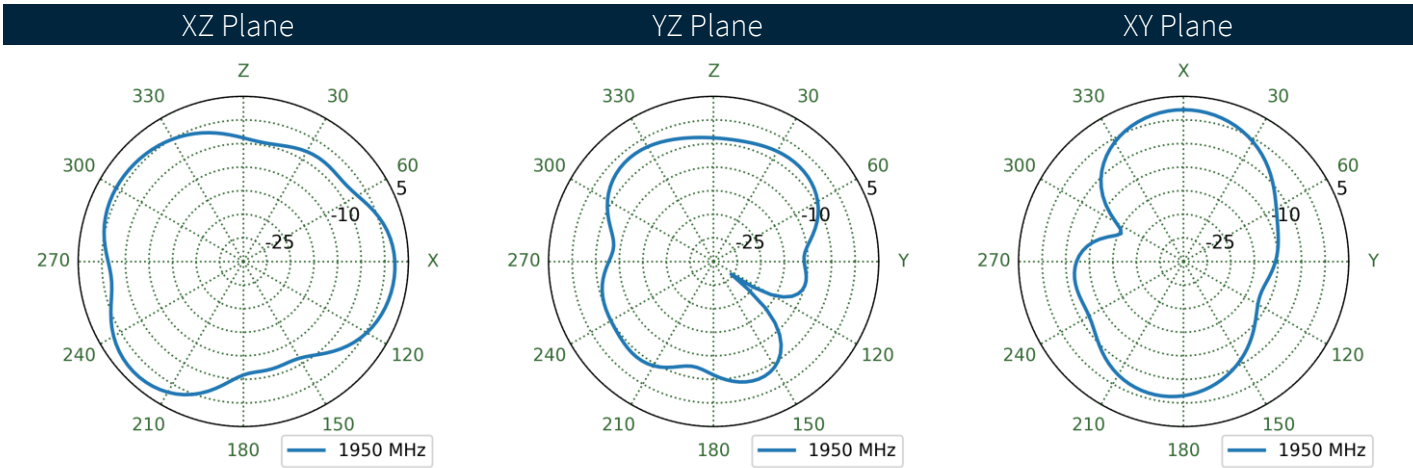
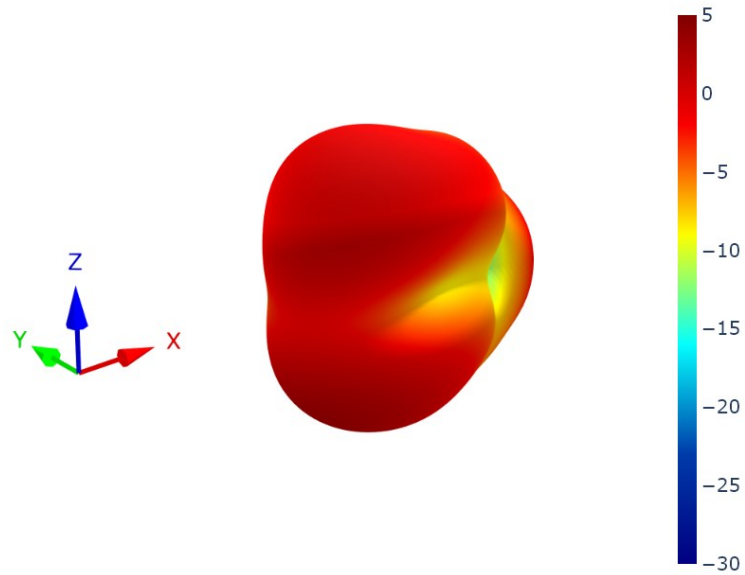

7.7 LTE Antenna 2 Patterns at 1950 MHz

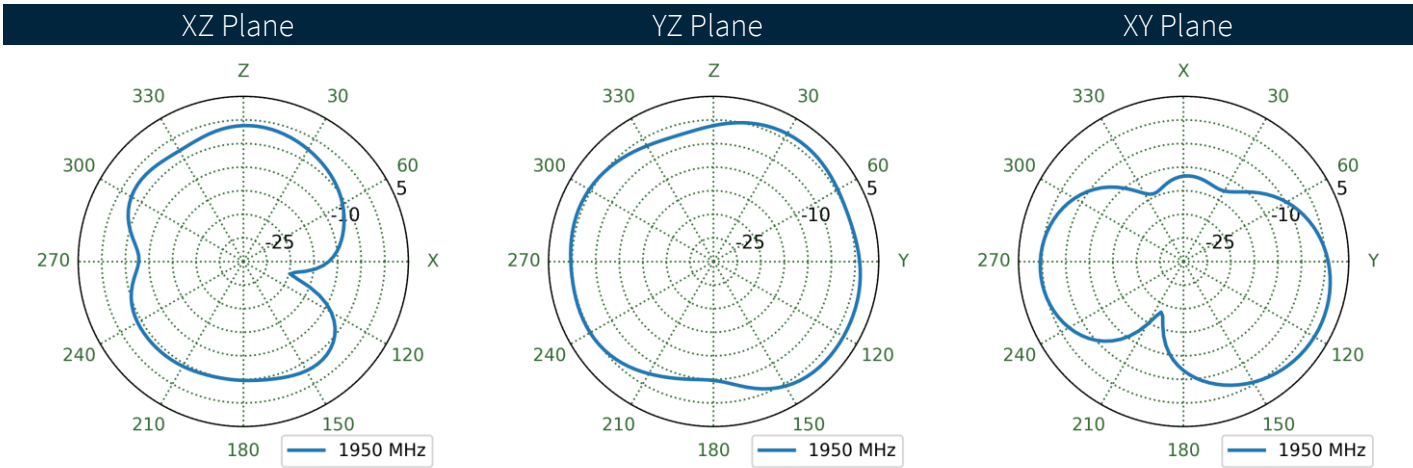
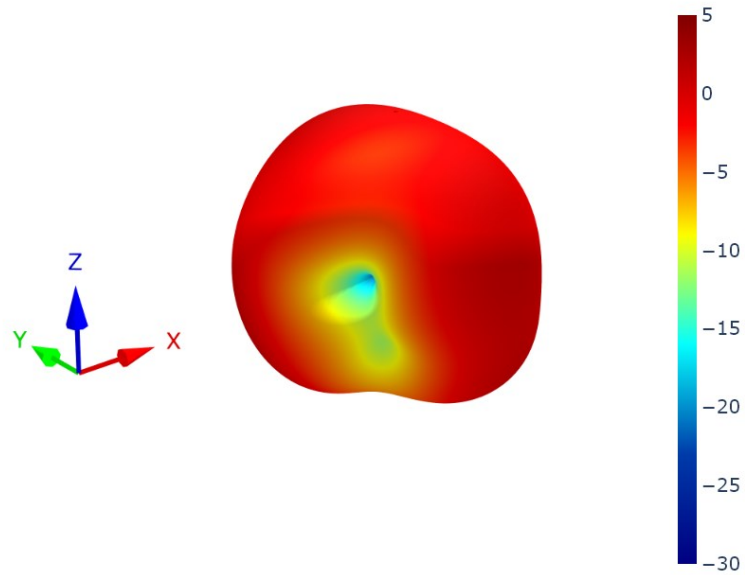

7.8 LTE Antenna 3 Patterns at 1950 MHz

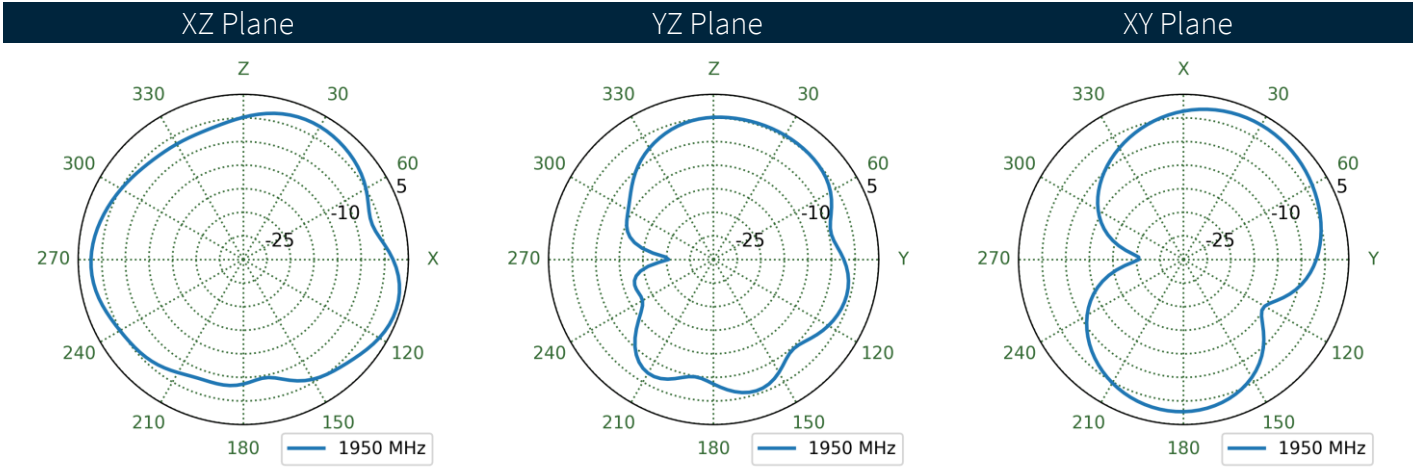
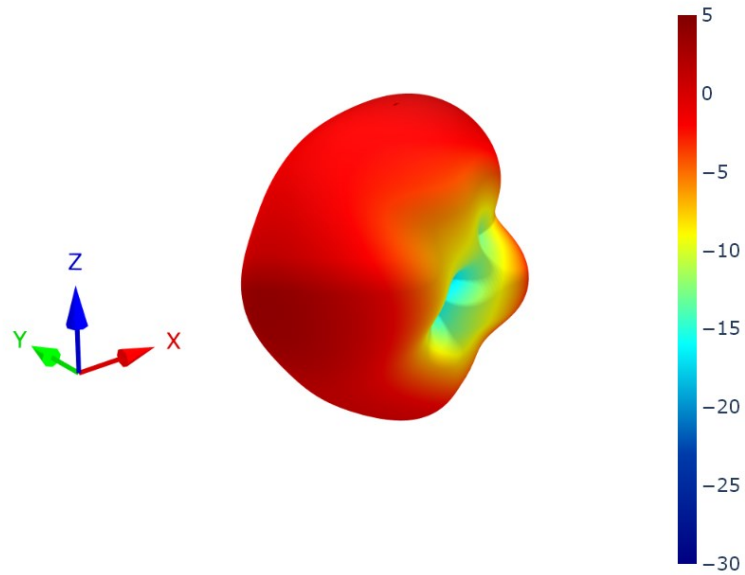

7.9 LTE Antenna 4 Patterns at 1950 MHz

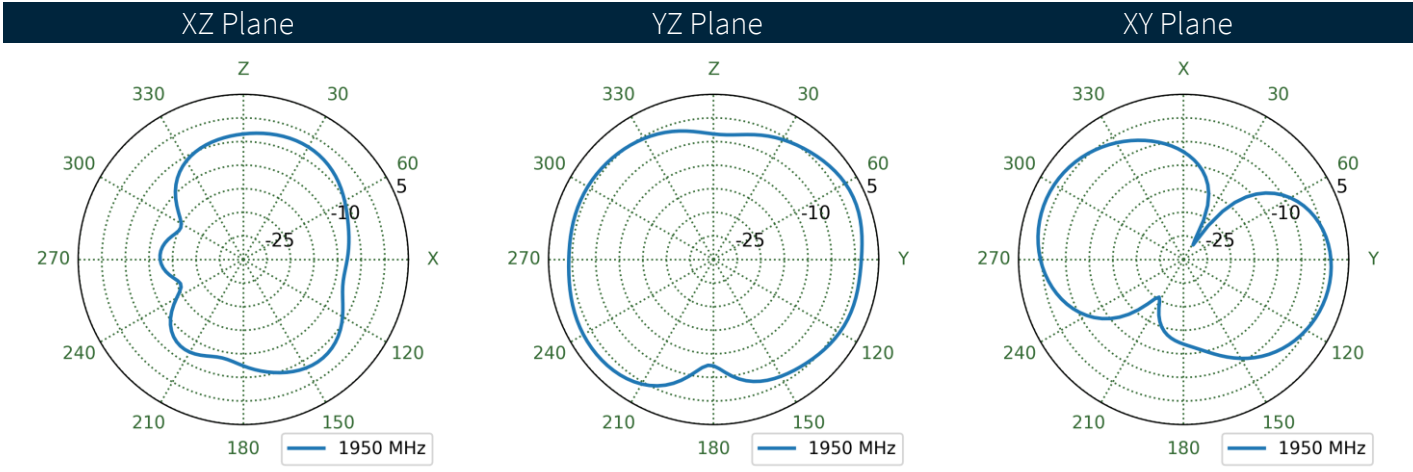
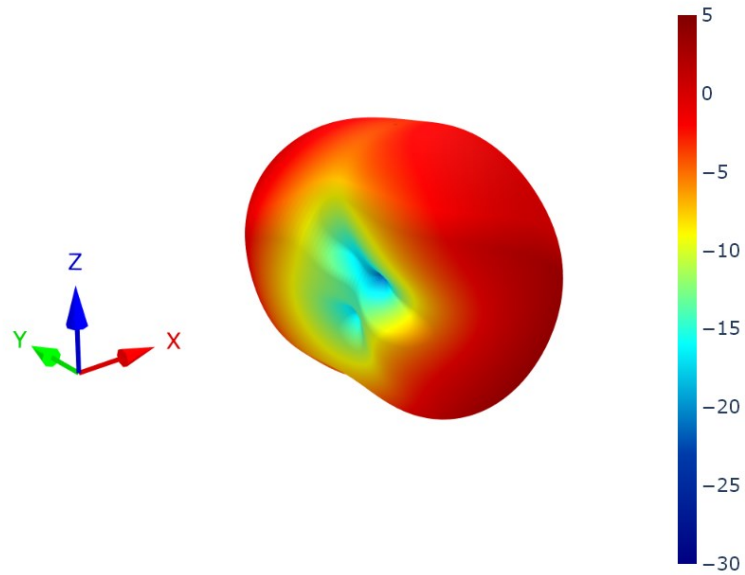

7.10 LTE Antenna 1 Patterns at 2350 MHz

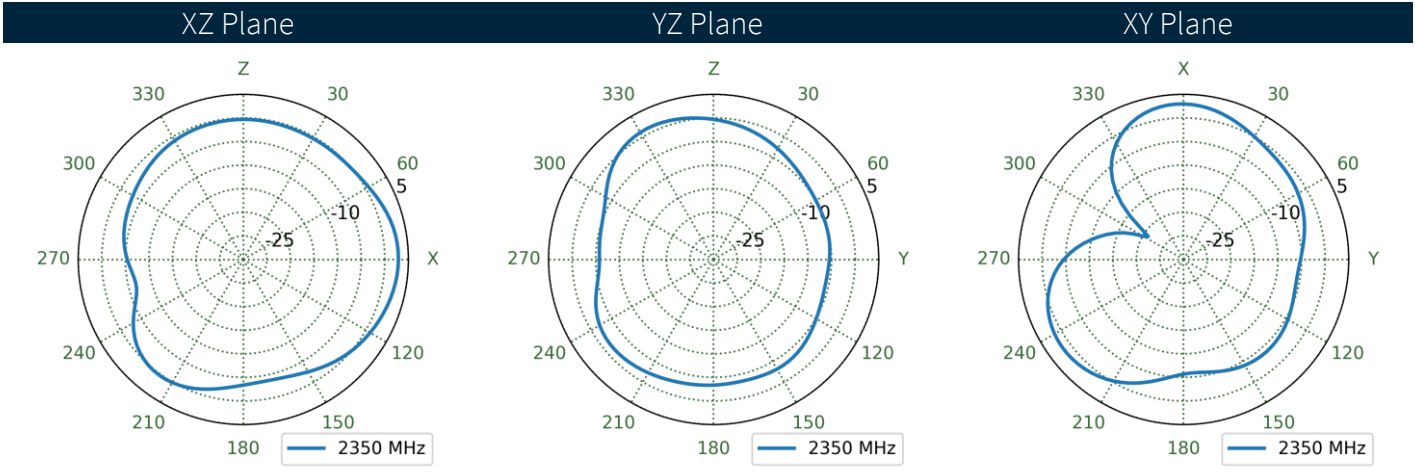
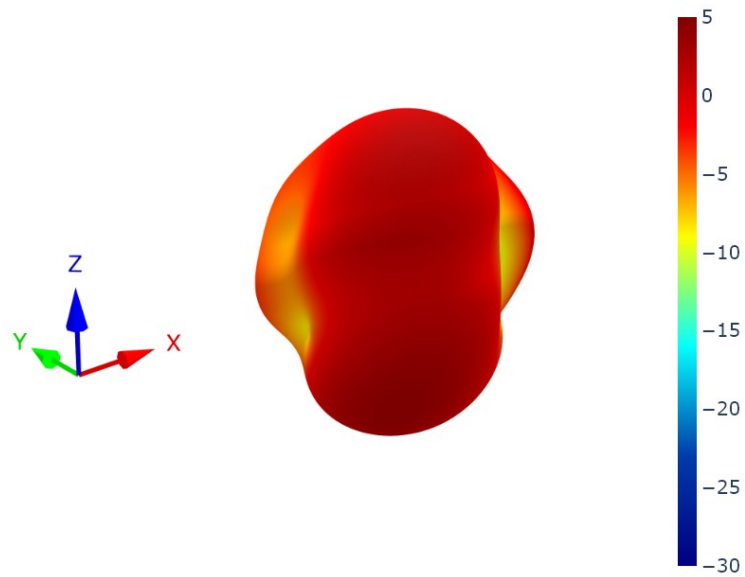

7.11 LTE Antenna 2 Patterns at 2350 MHz

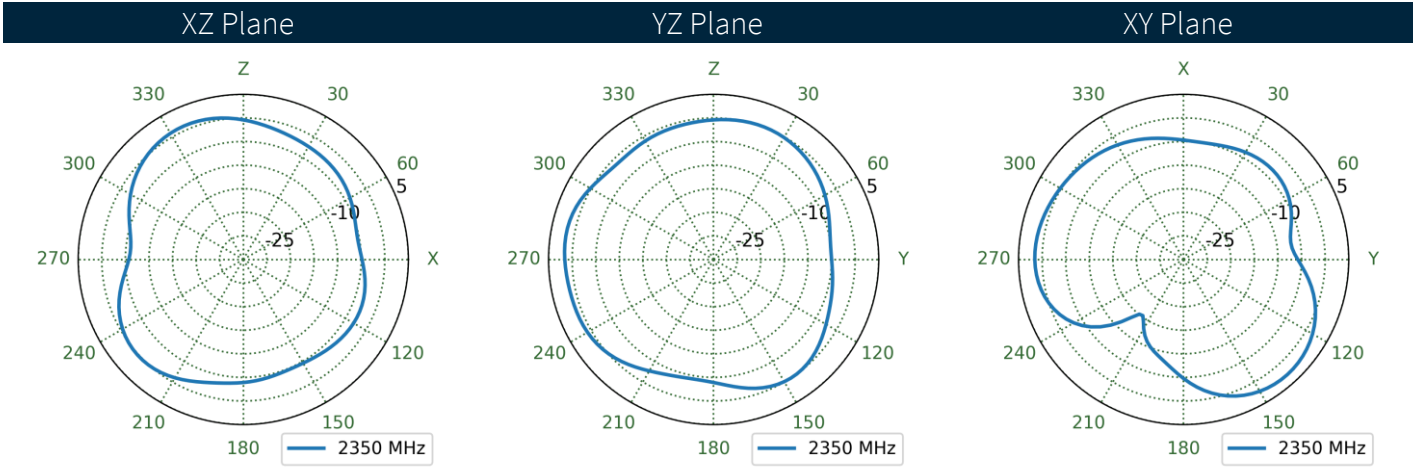
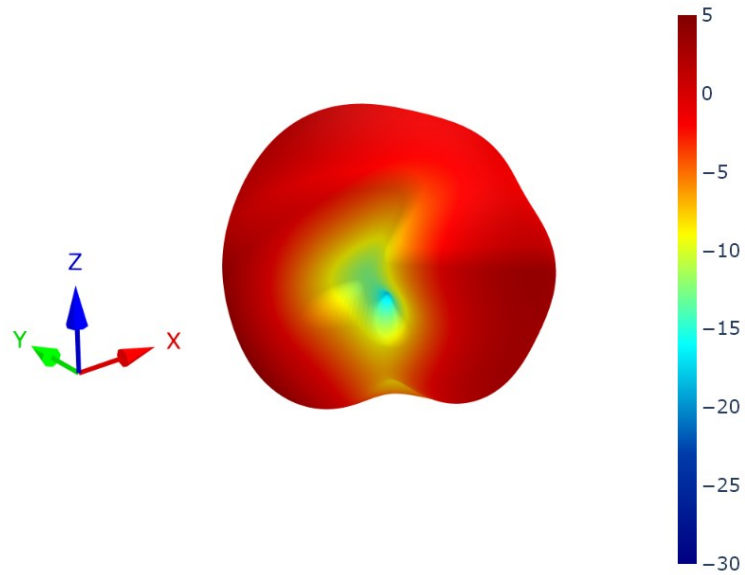

7.12 LTE Antenna 3 Patterns at 2350 MHz

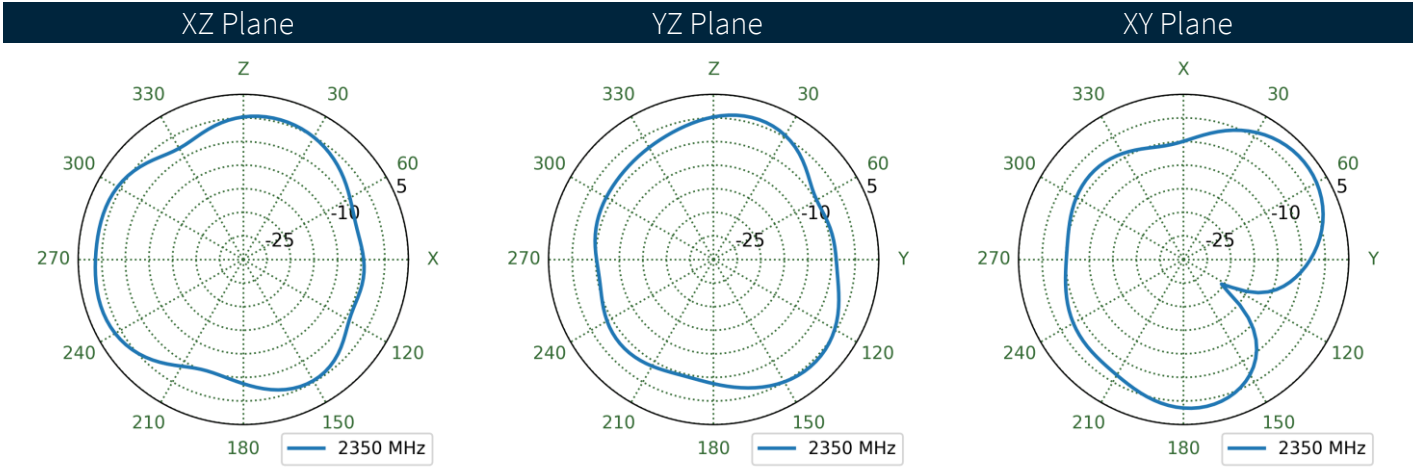
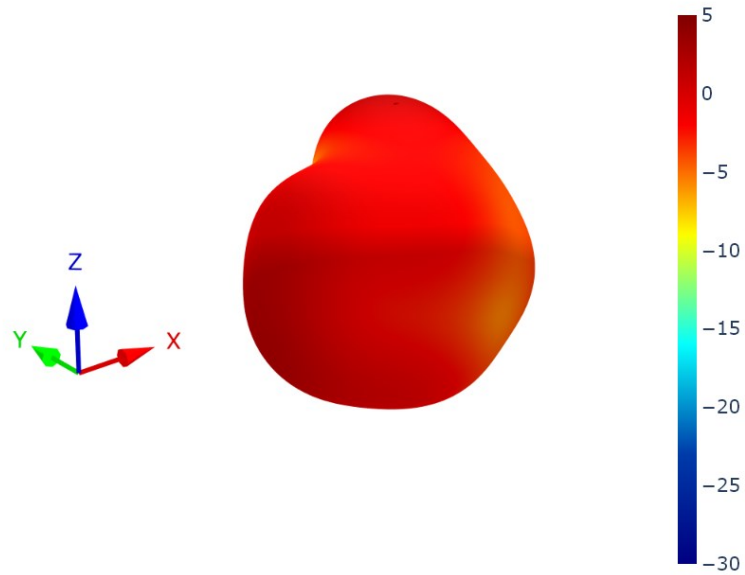

7.13 LTE Antenna 4 Patterns at 2350 MHz

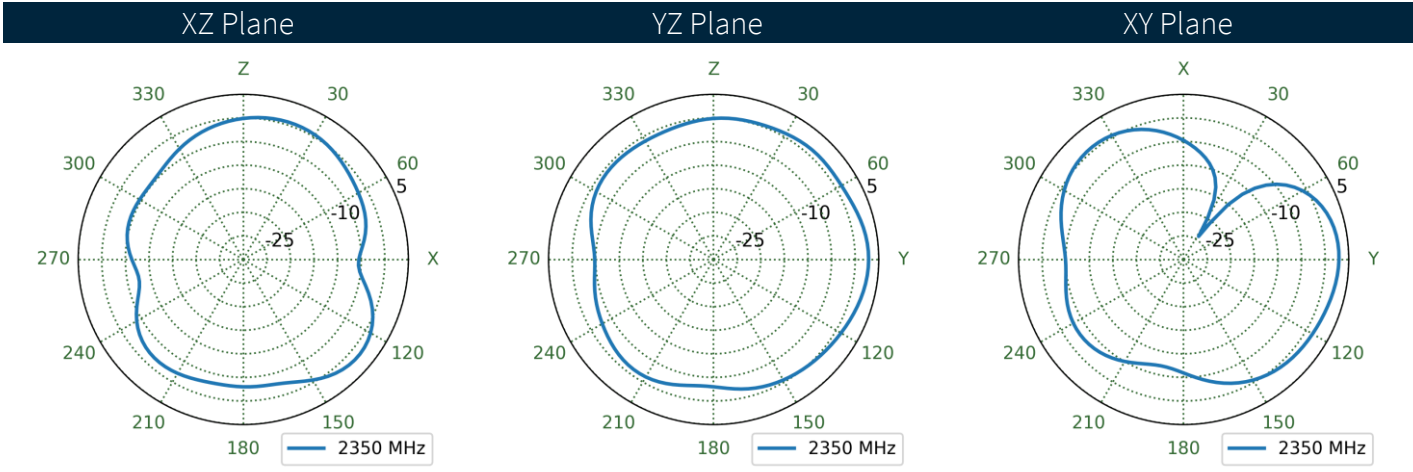
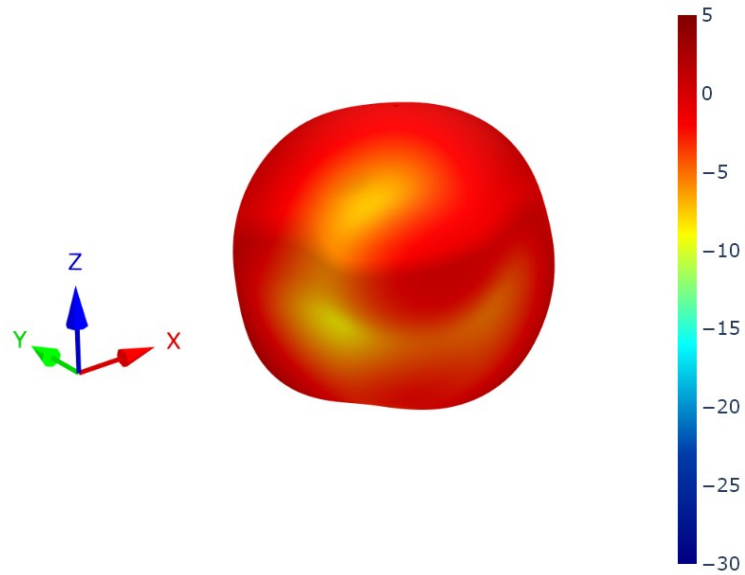

7.14 LTE Antenna 1 Patterns at 2590 MHz

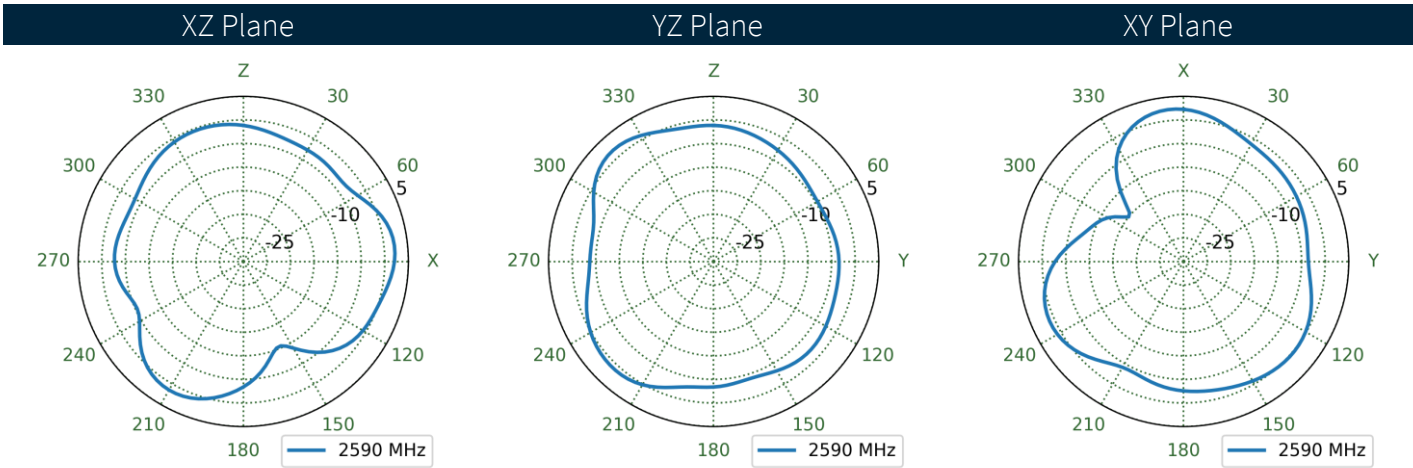
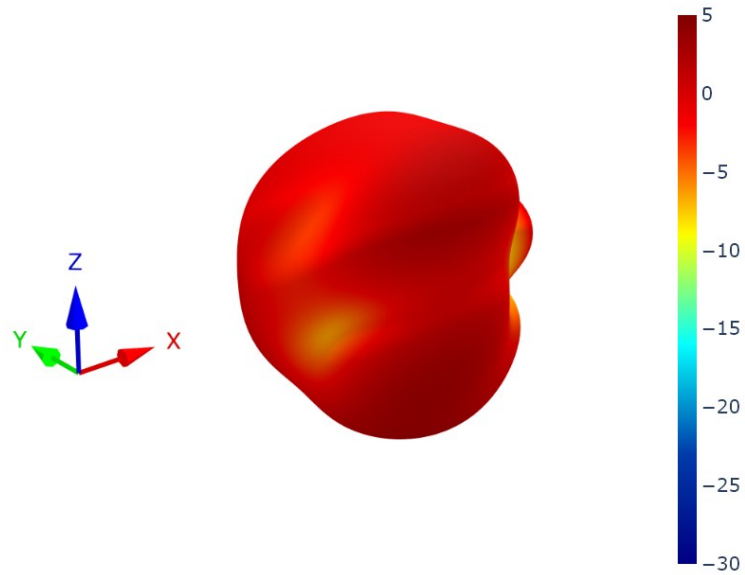

7.15 LTE Antenna 2 Patterns at 2590 MHz

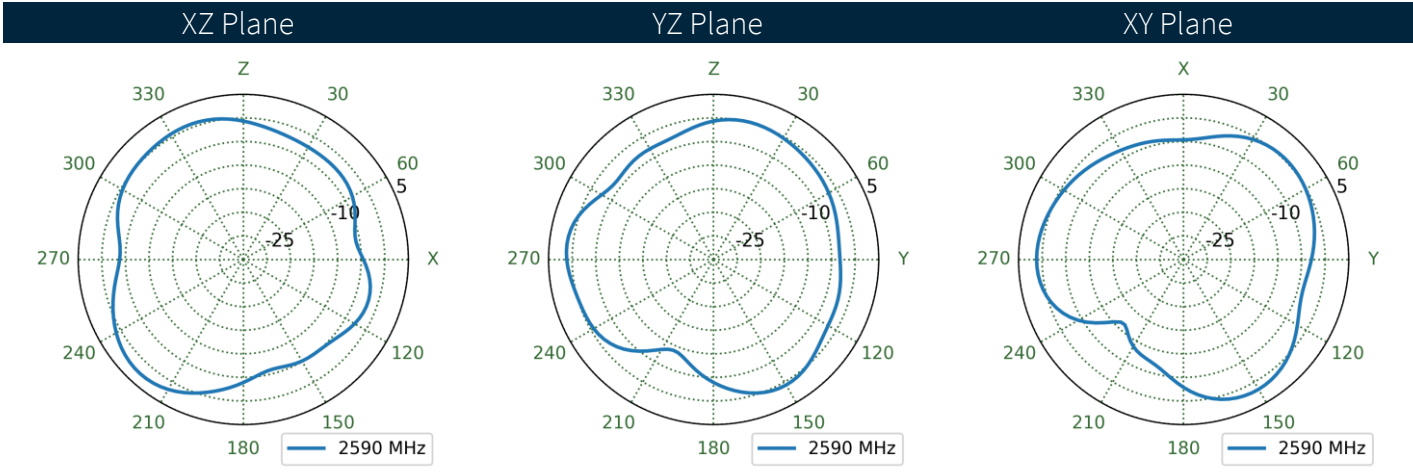
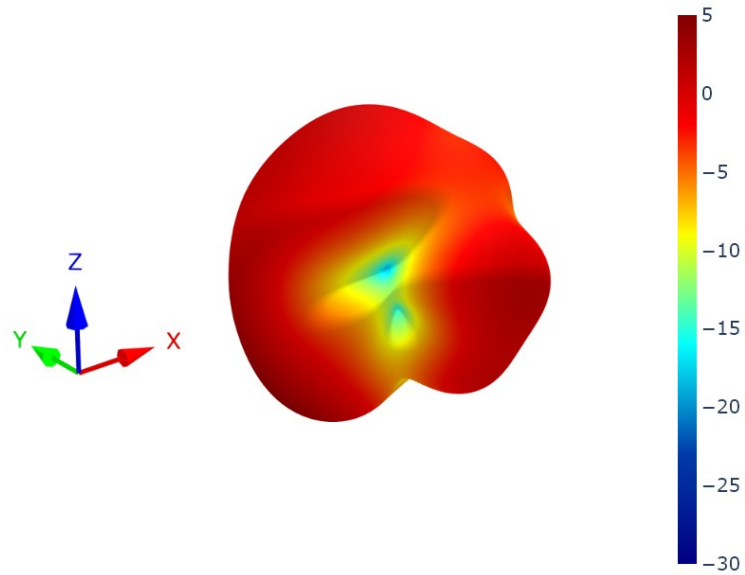

7.16 LTE Antenna 3 Patterns at 2590 MHz

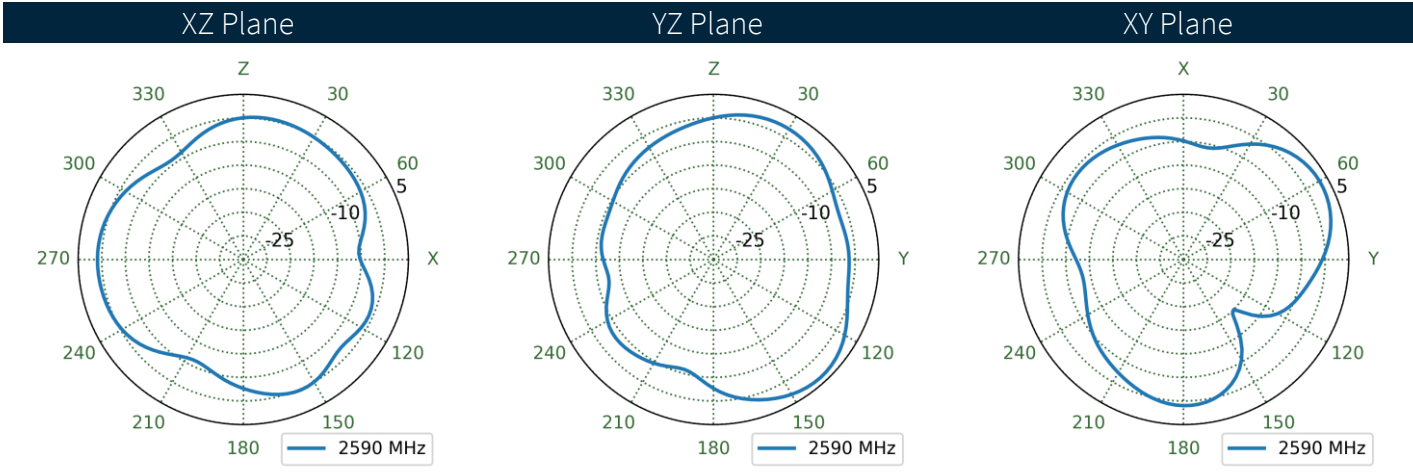
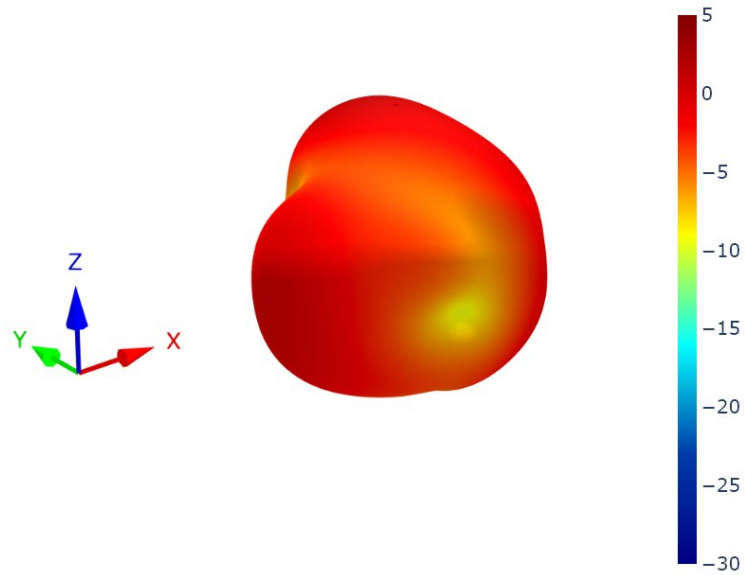

7.17 LTE Antenna 4 Patterns at 2590 MHz

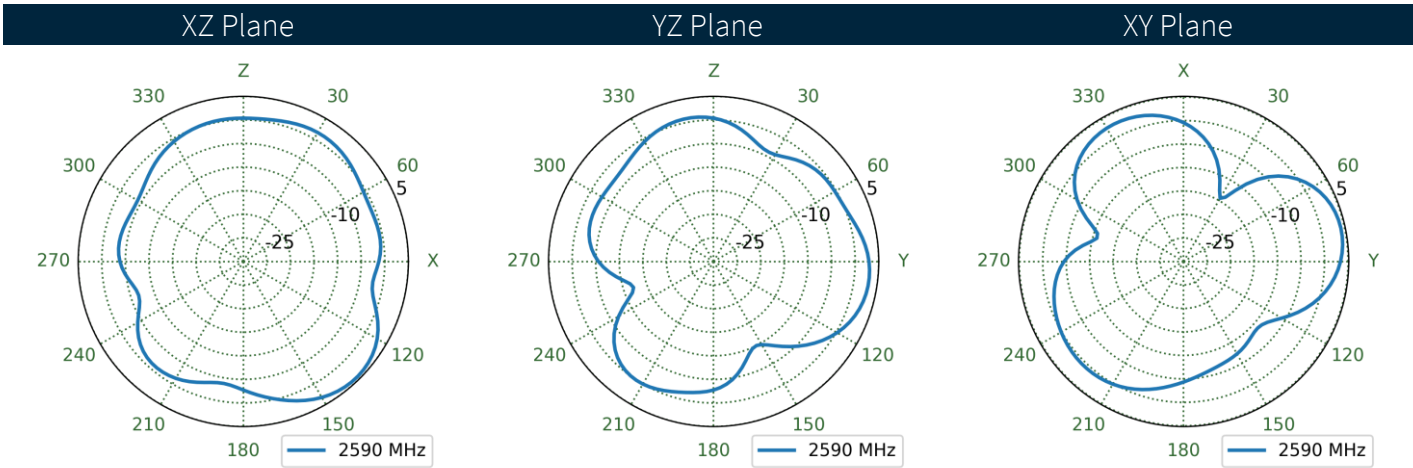
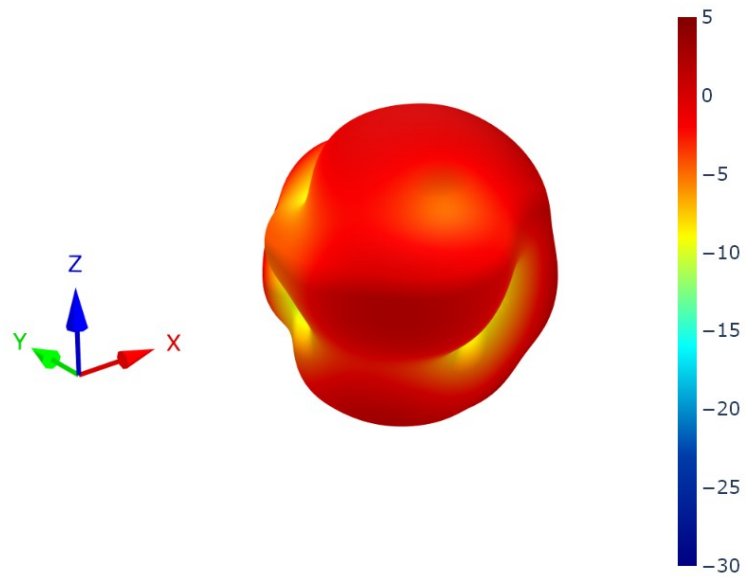

7.18 LTE Antenna 1 Patterns at 3750 MHz

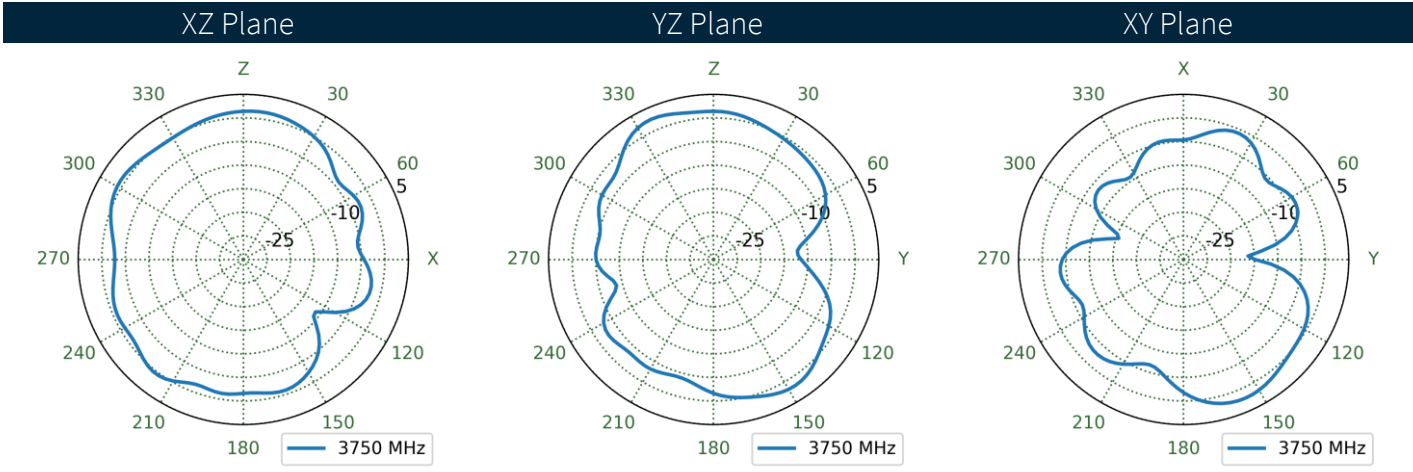
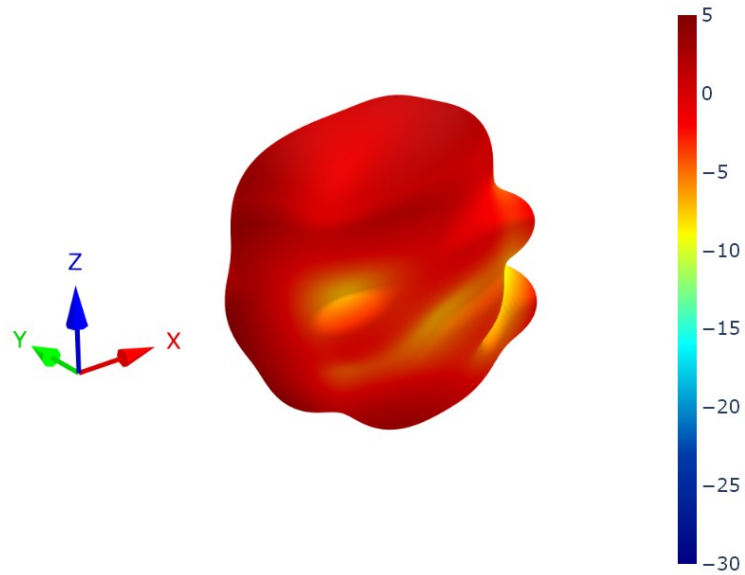

7.19 LTE Antenna 2 Patterns at 3750 MHz

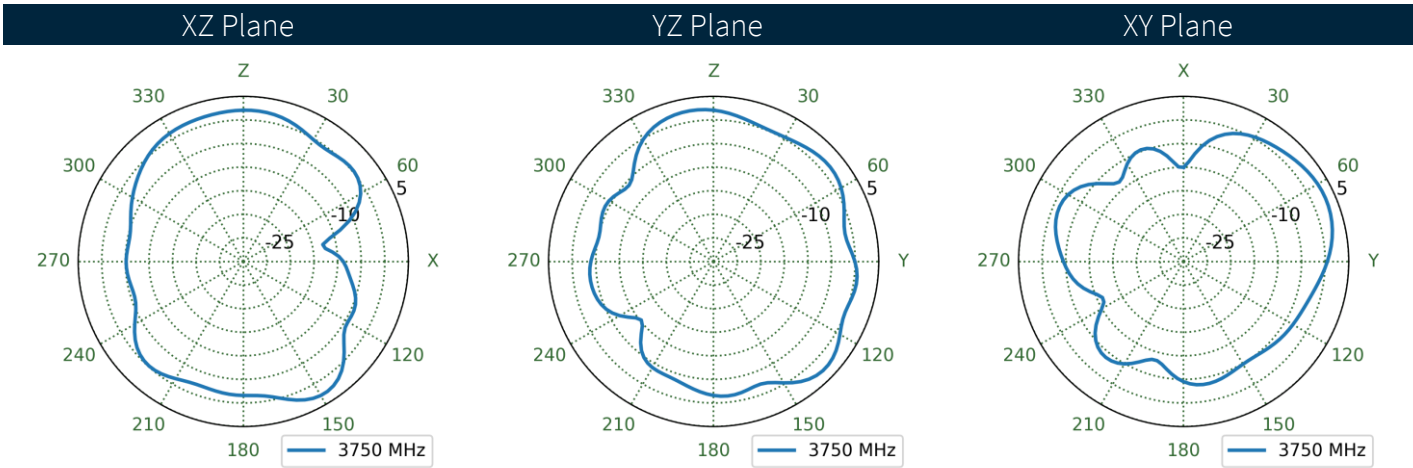
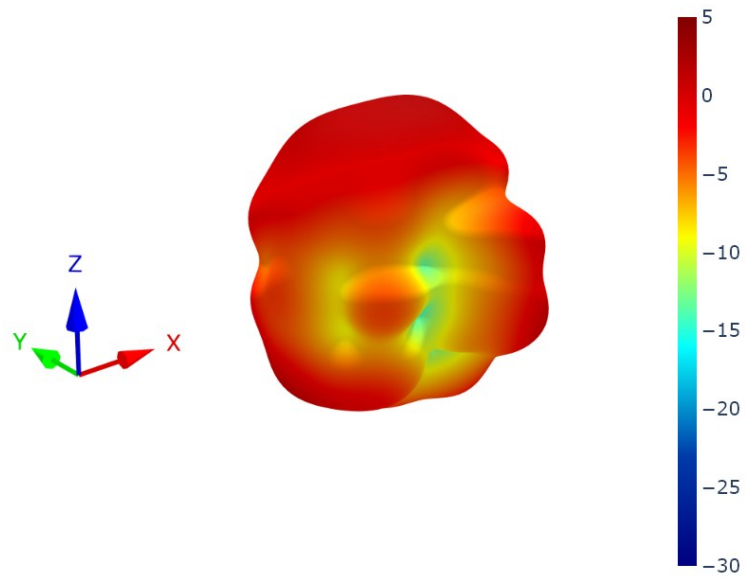

7.20 LTE Antenna 3 Patterns at 3750 MHz

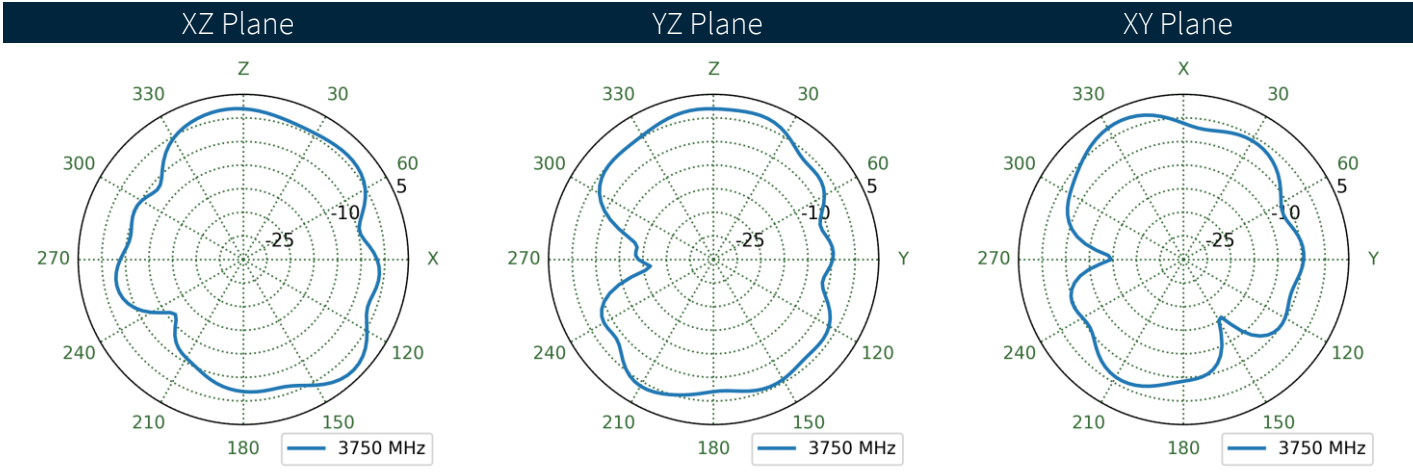
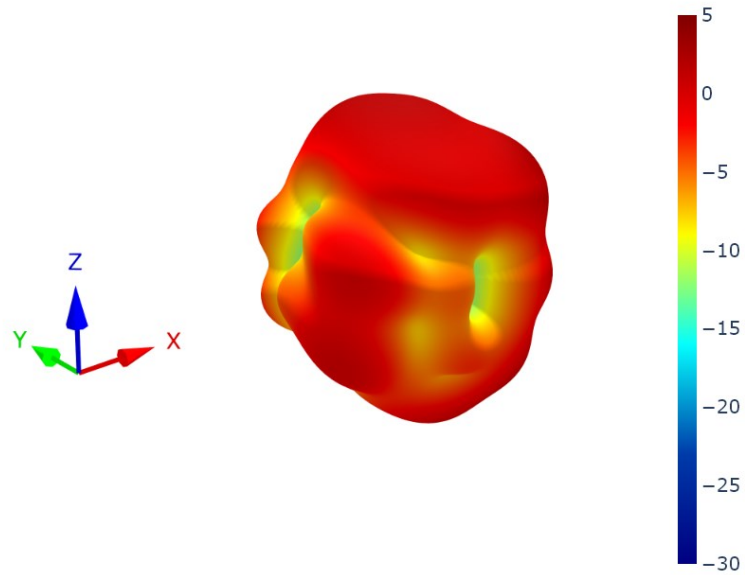

7.21 LTE Antenna 4 Patterns at 3750 MHz

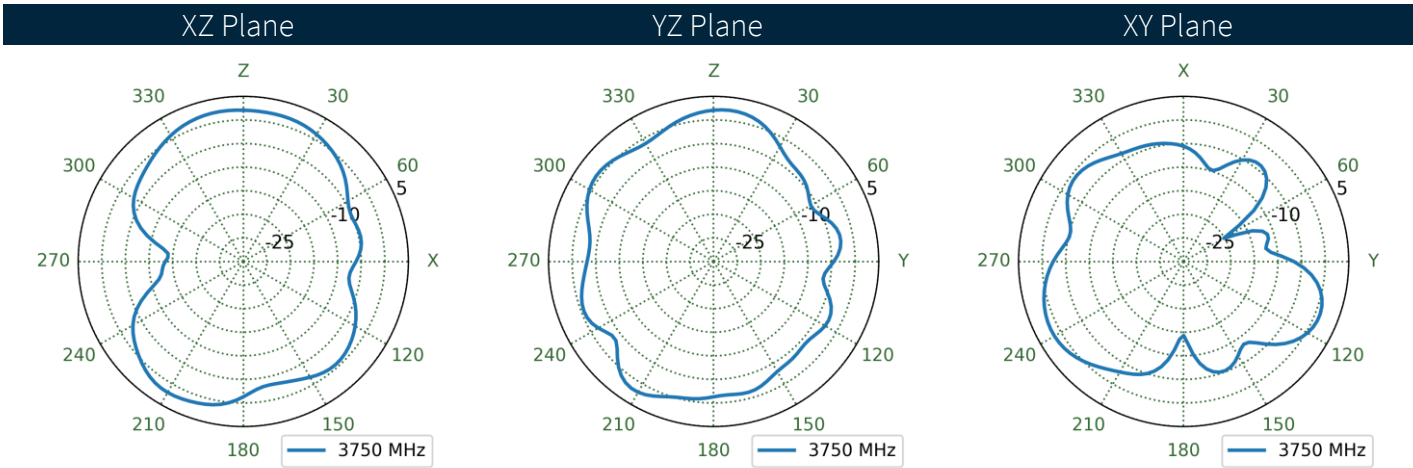
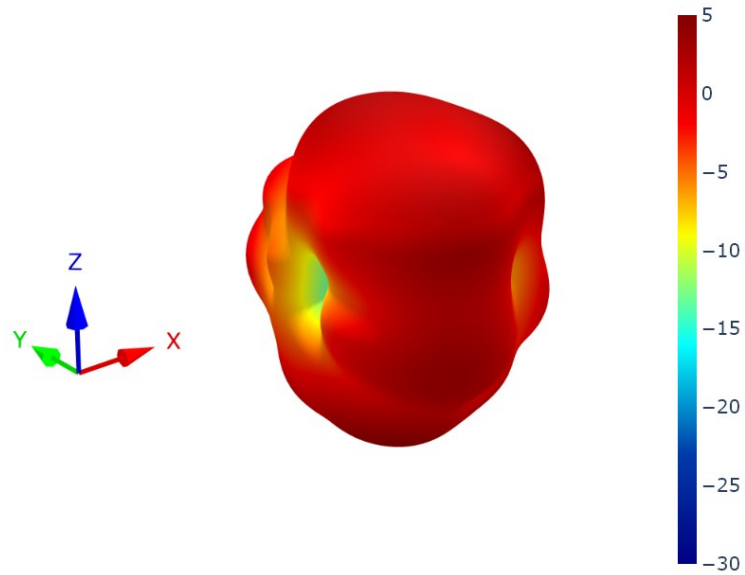

7.22 LTE Antenna 1 Patterns at 4700 MHz

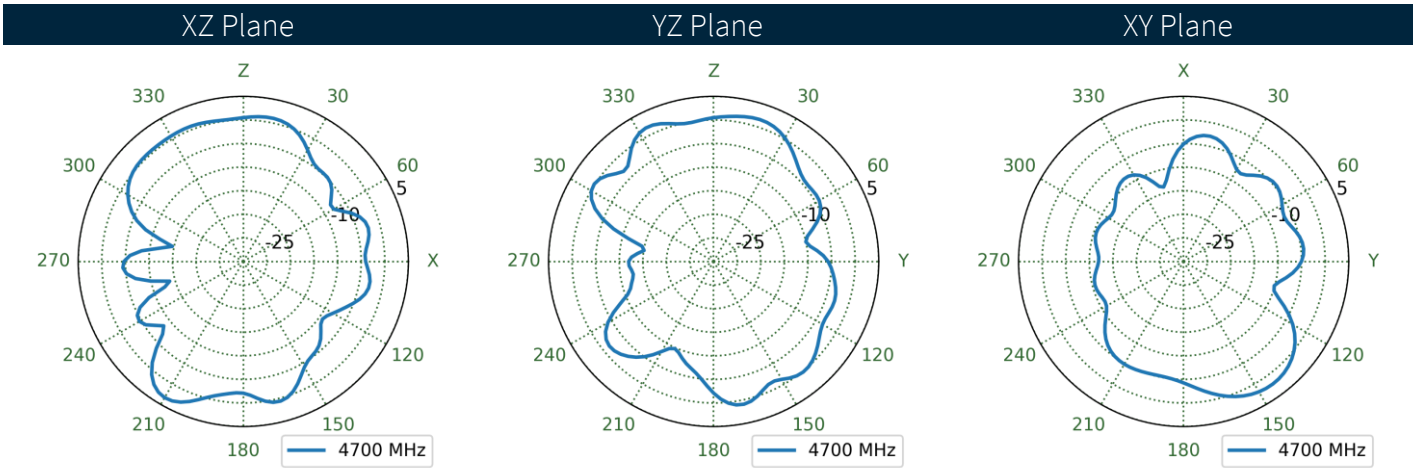
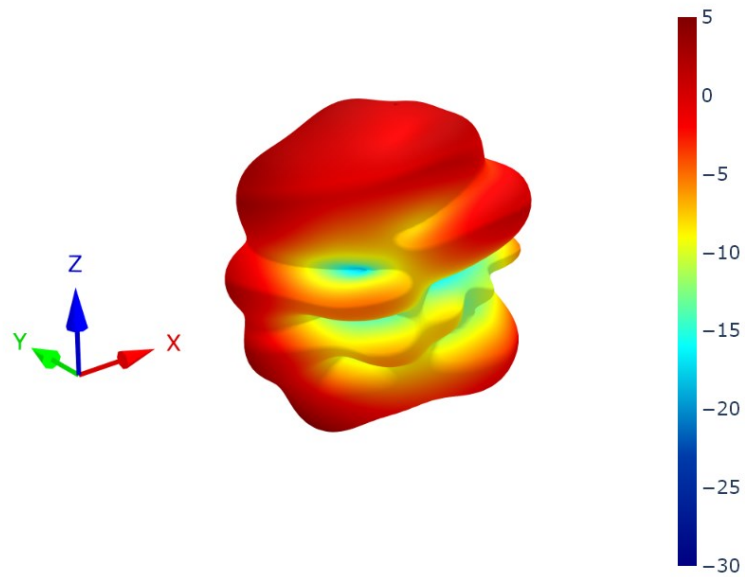

7.23 LTE Antenna 2 Patterns at 4700 MHz

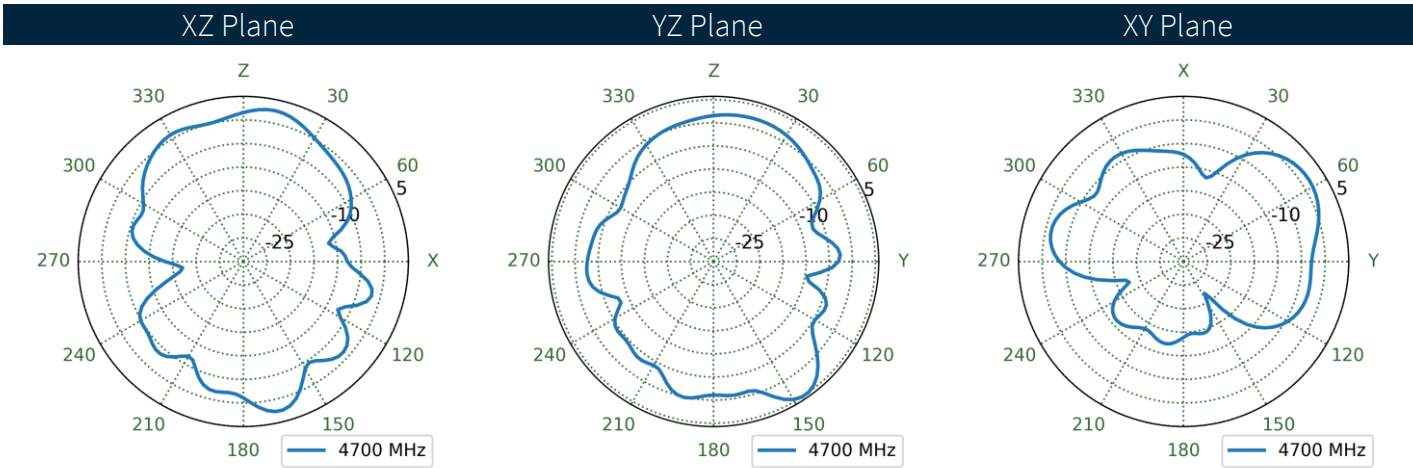
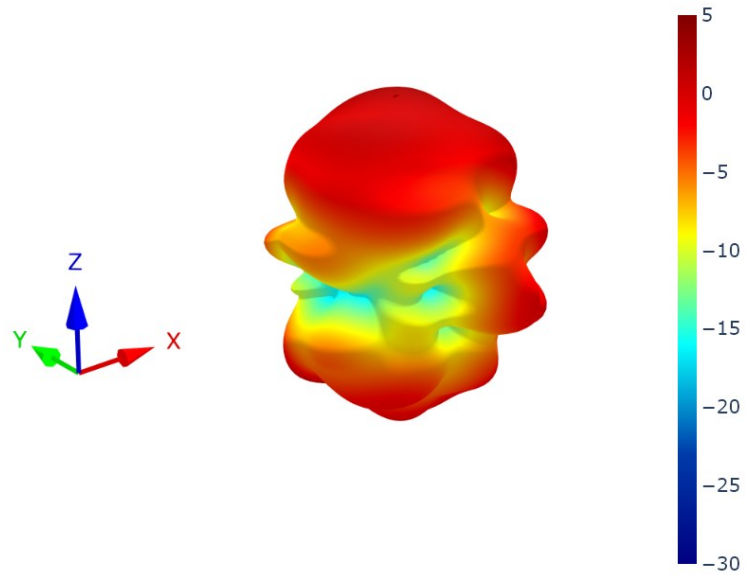

7.24 LTE Antenna 3 Patterns at 4700 MHz

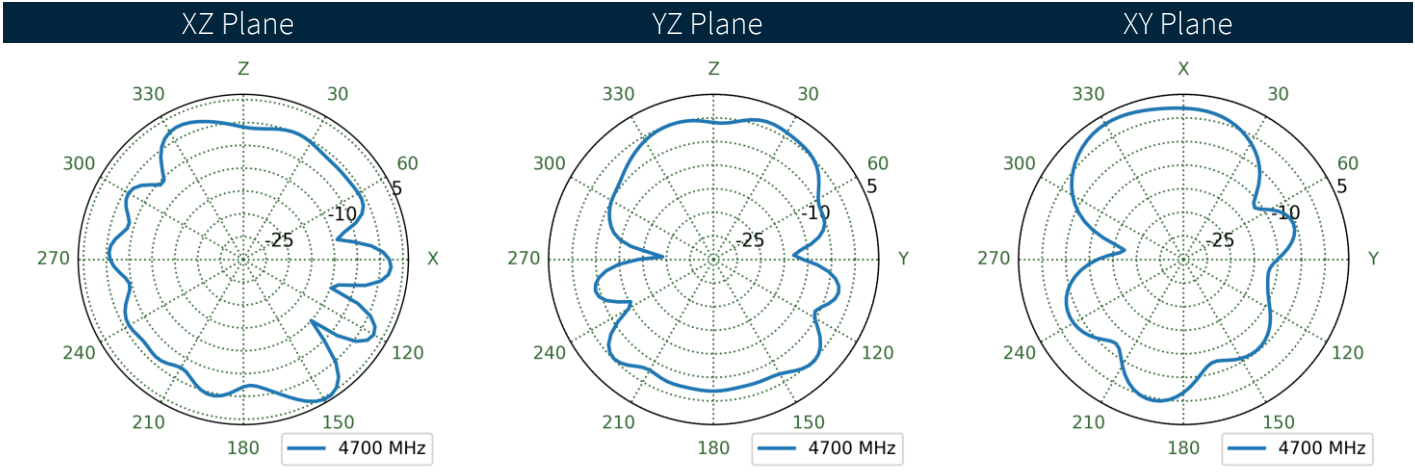
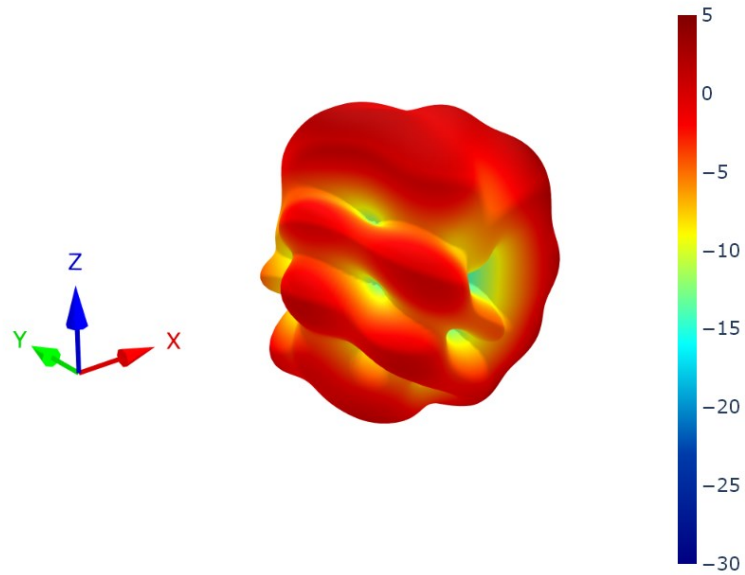

7.25 LTE Antenna 4 Patterns at 4700 MHz

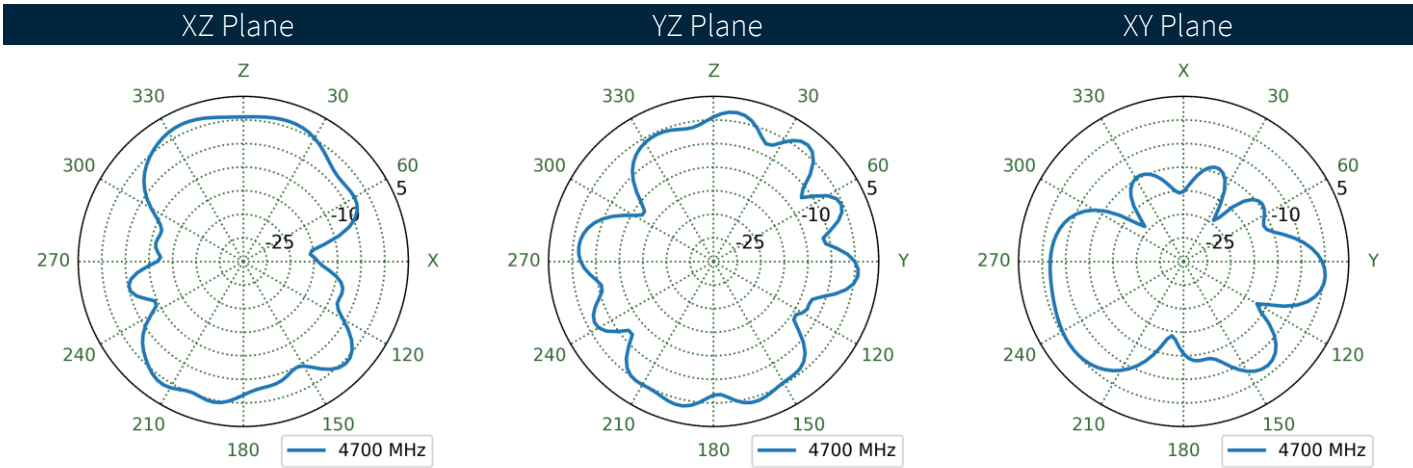
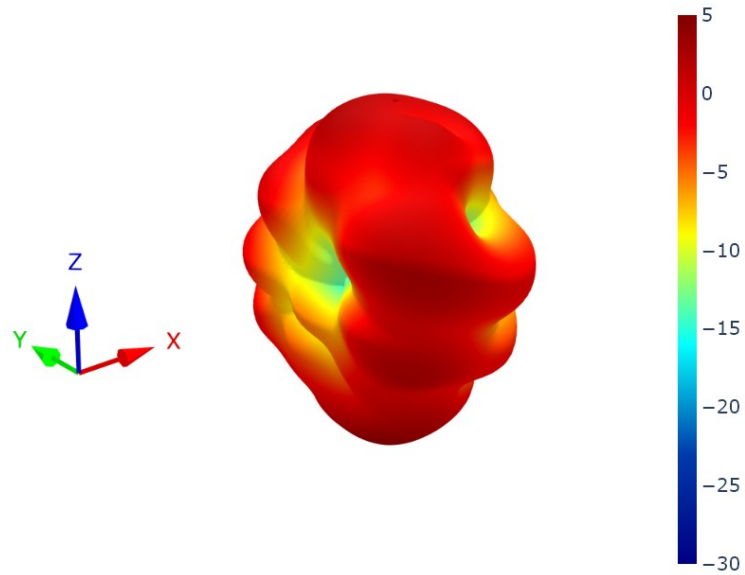

7.26 LTE Antenna 1 Patterns at 5550 MHz

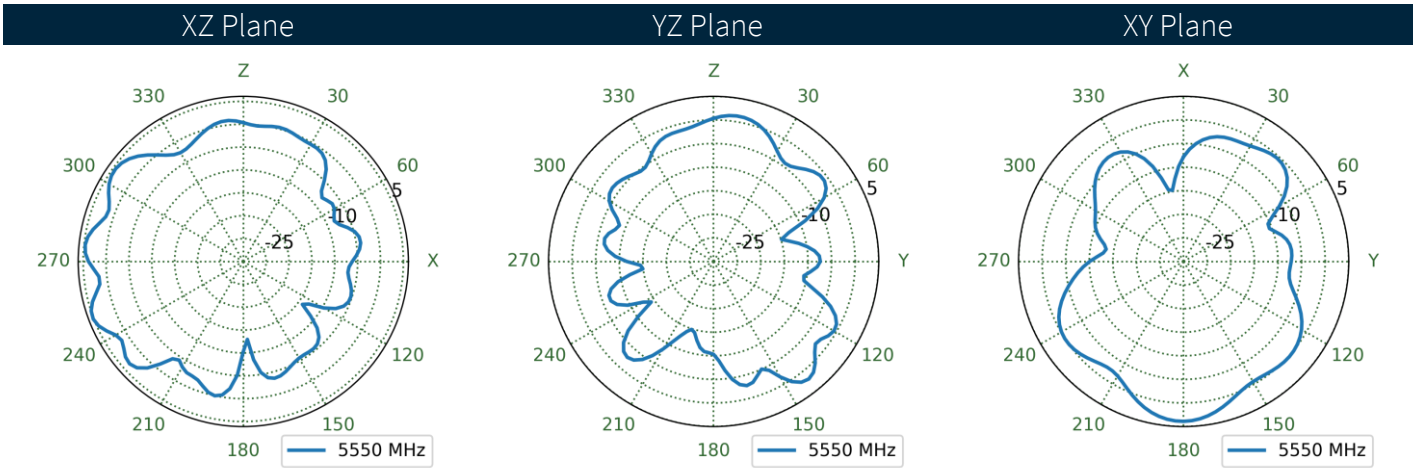
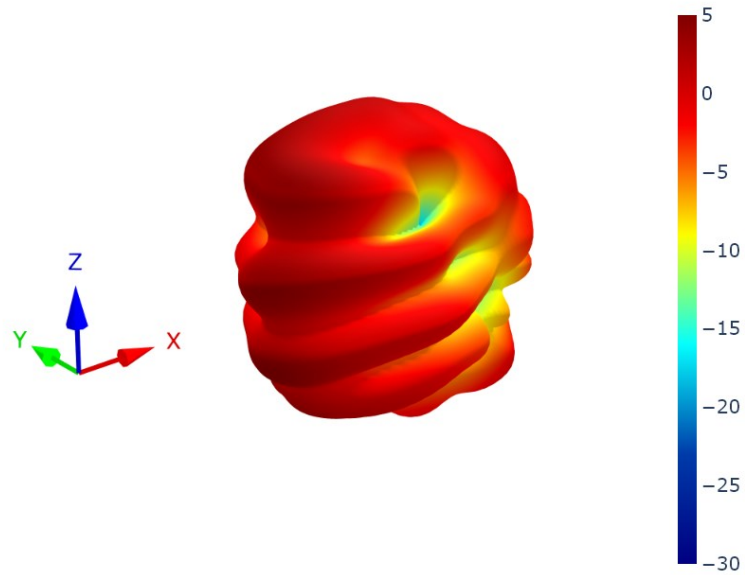

7.27 LTE Antenna 2 Patterns at 5550 MHz

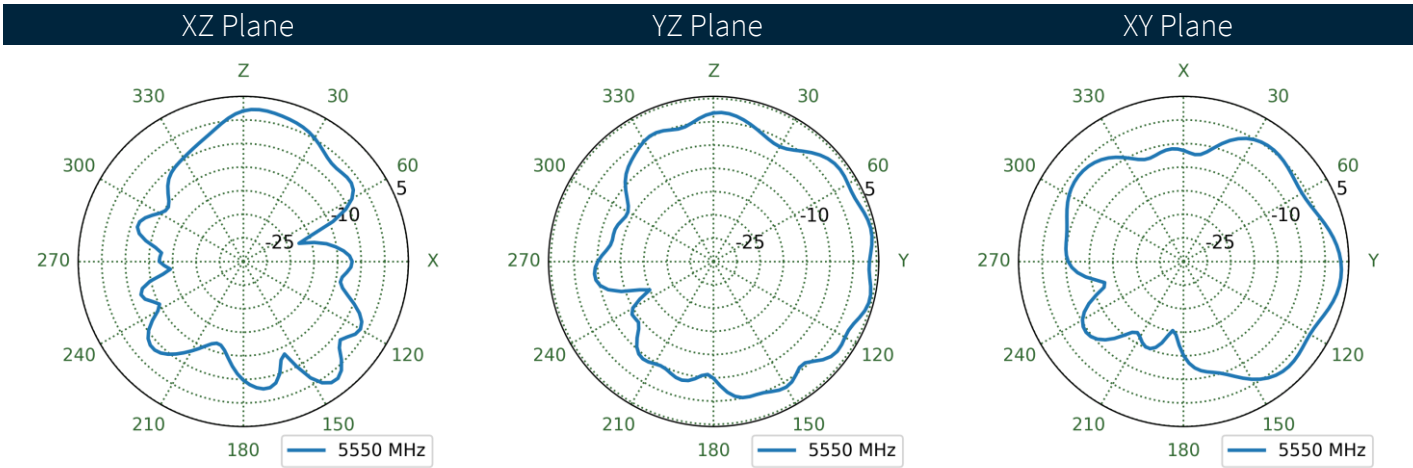
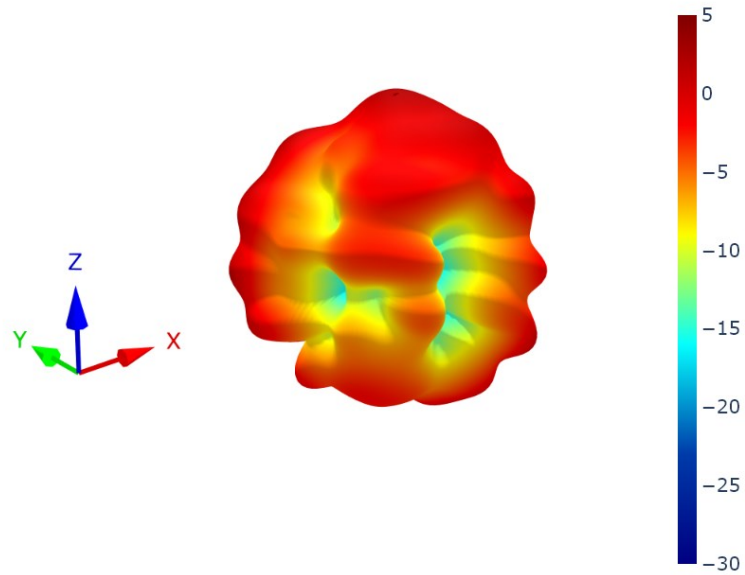

7.28 LTE Antenna 3 Patterns at 5550 MHz

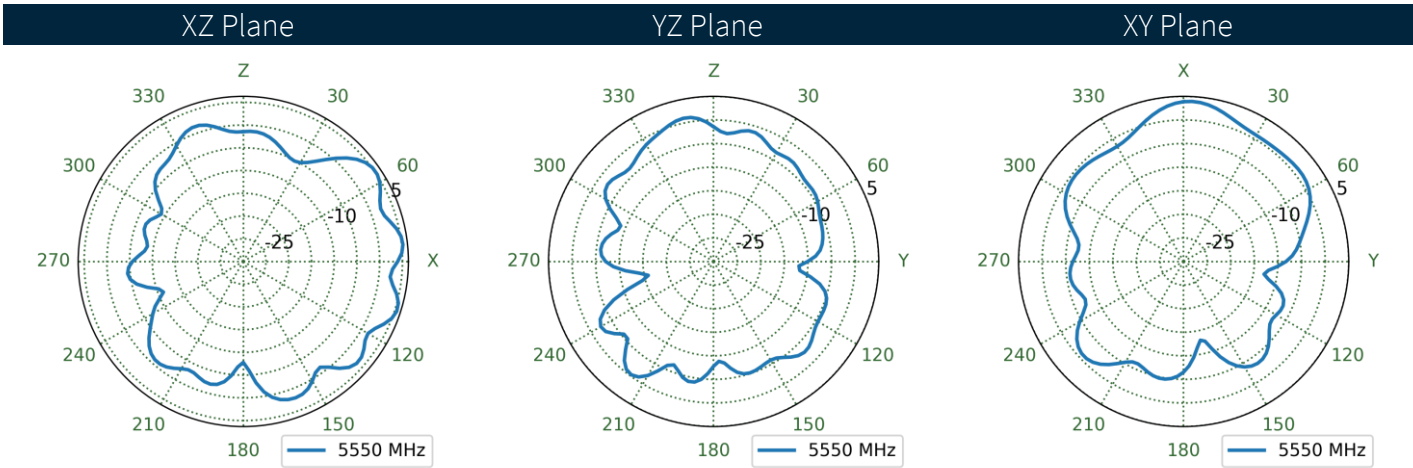
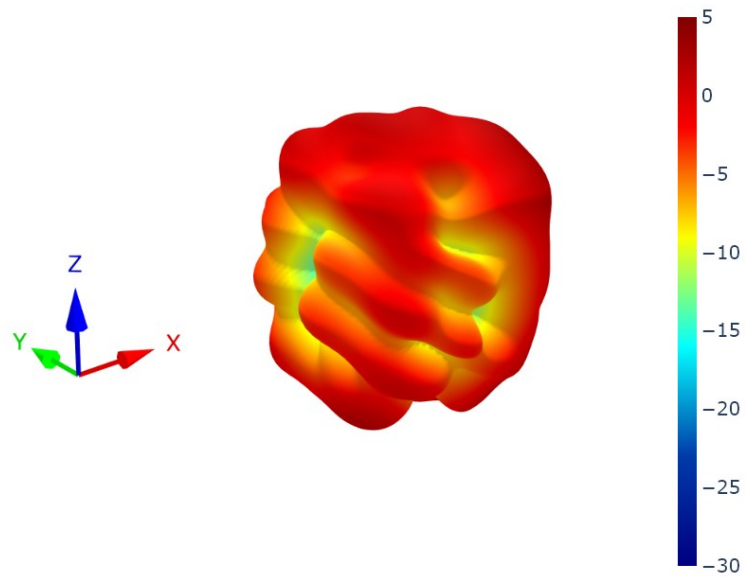

7.29 LTE Antenna 4 Patterns at 5550 MHz

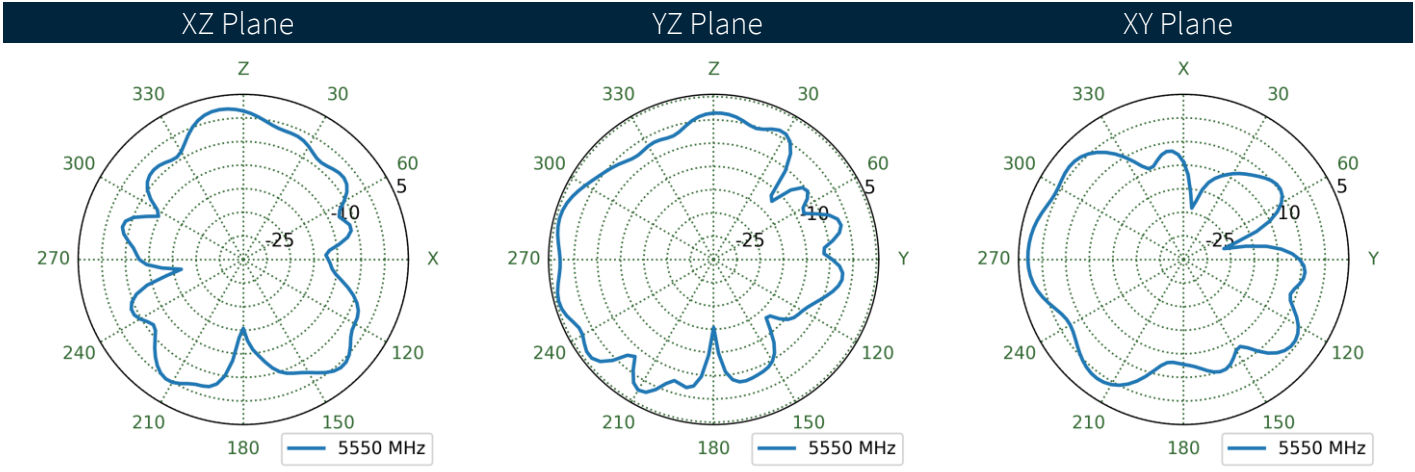
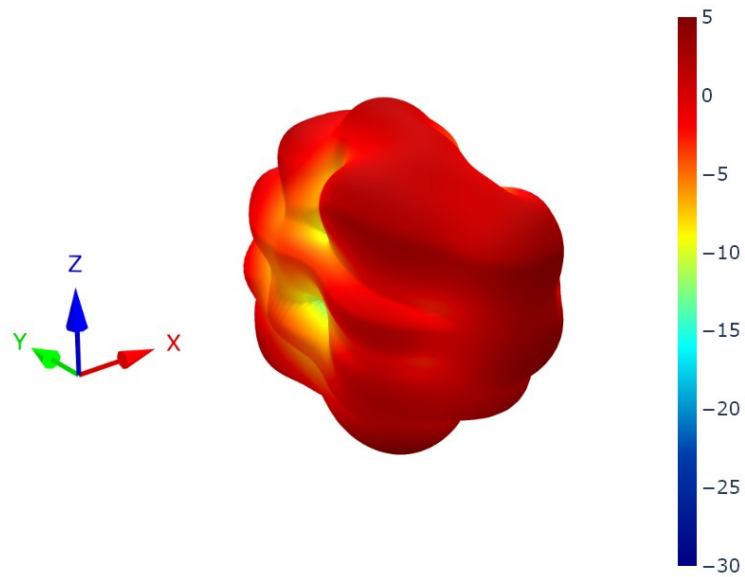

8. Radiation Patterns (Outer)

8.1 Test Setup

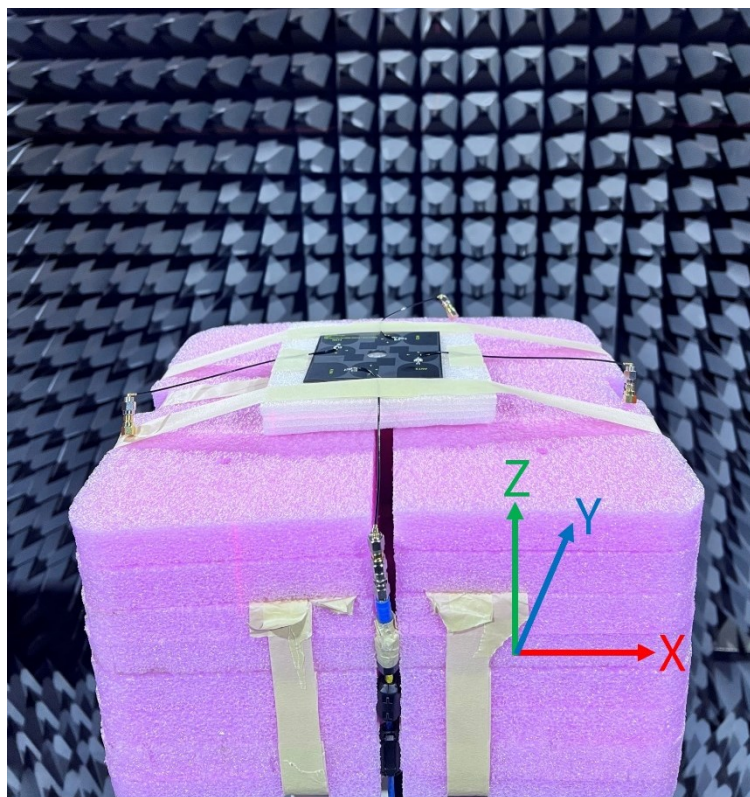
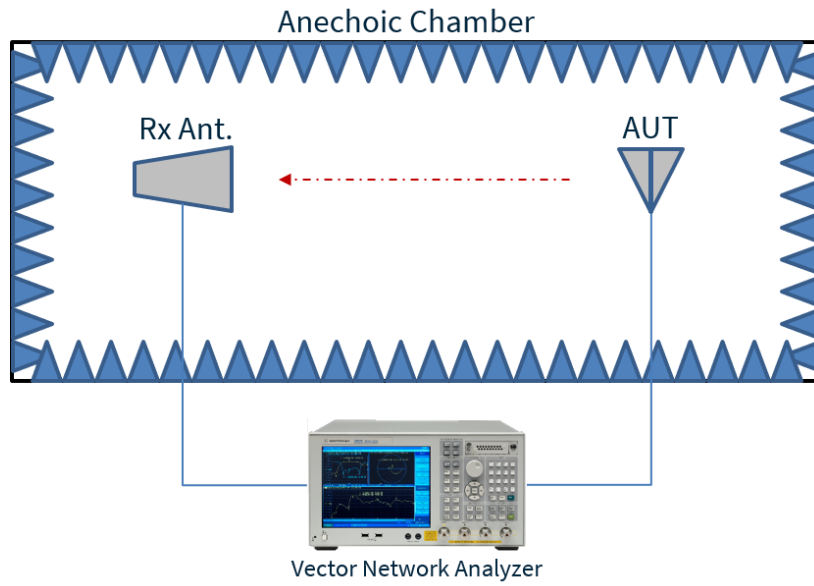

Chamber Set-up with cables going outward away from the Antenna

8.2 Antenna 1 Patterns at 1545 MHz

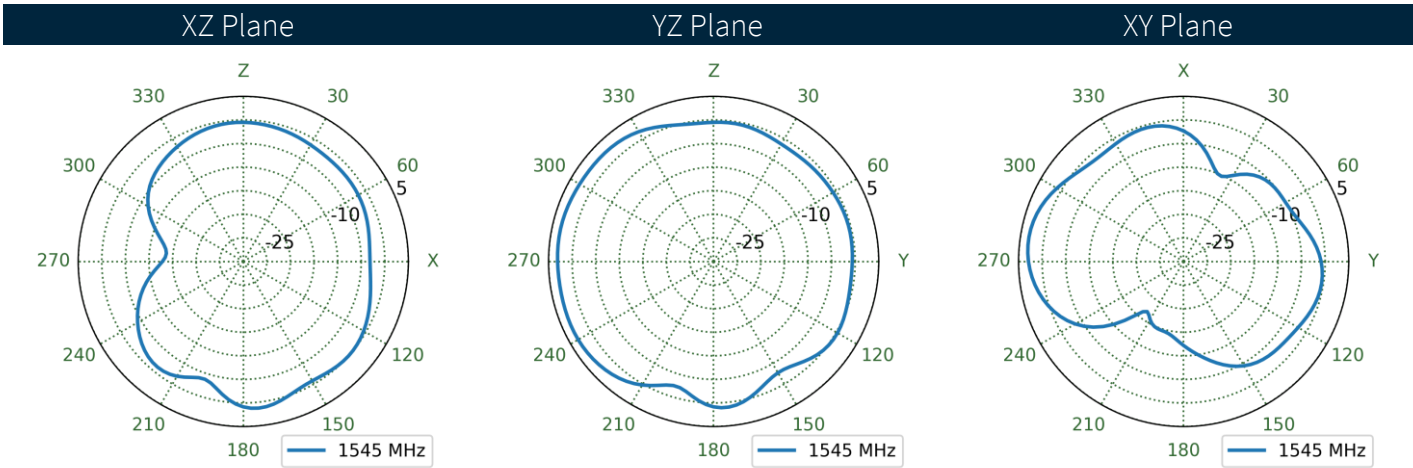
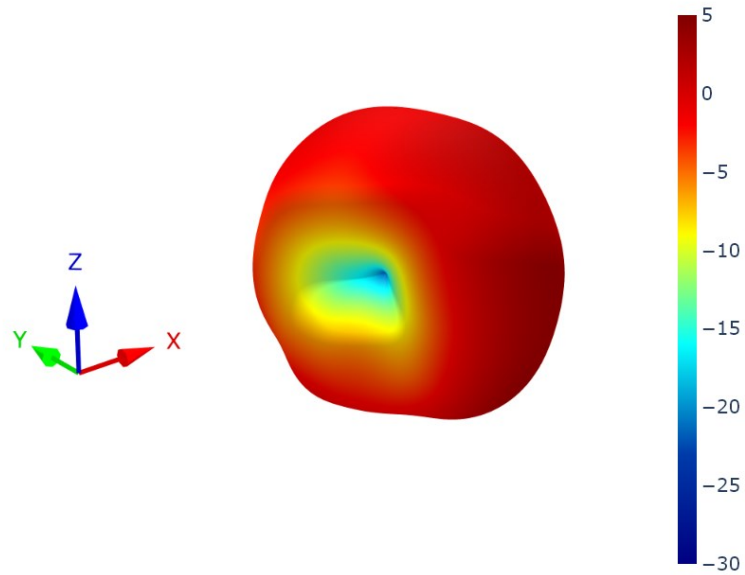

8.3 Antenna 2 Patterns at 1545 MHz

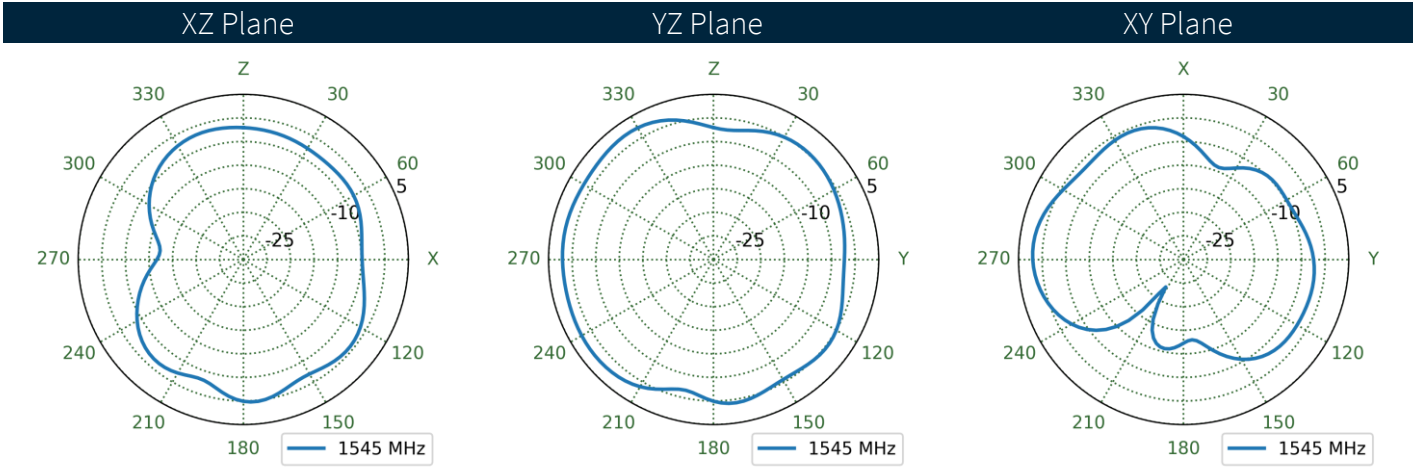
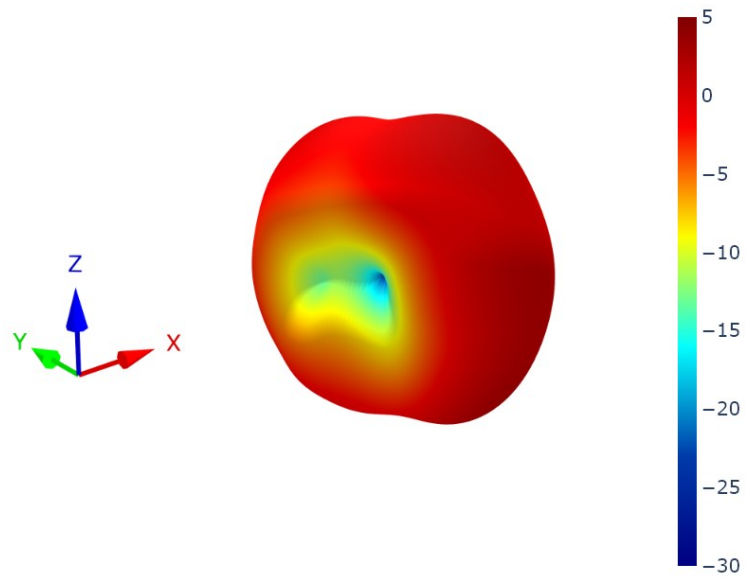

8.4 Antenna 3 Patterns at 1545 MHz

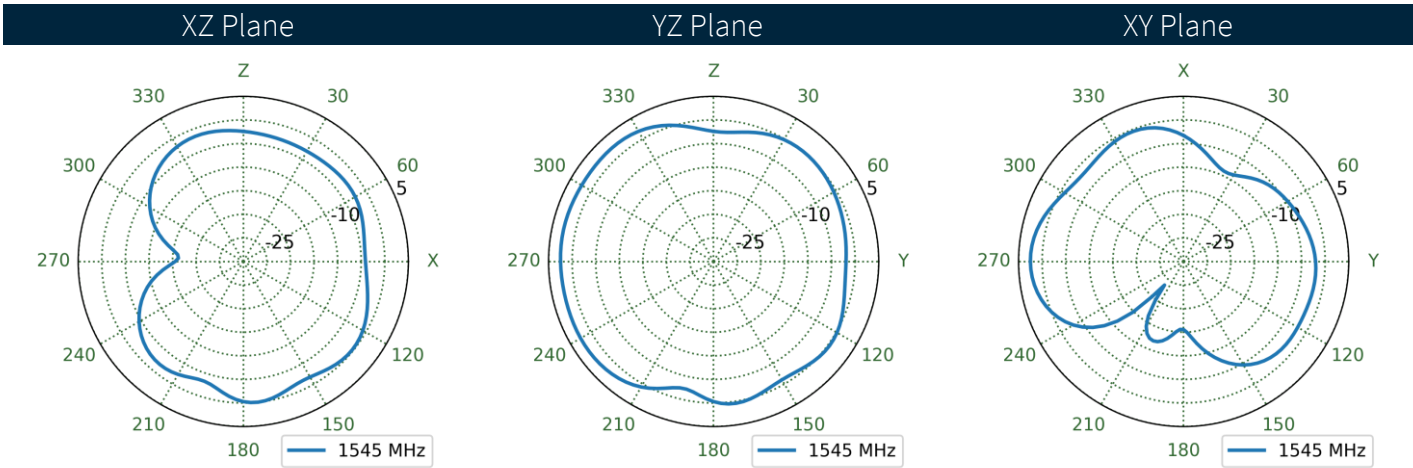
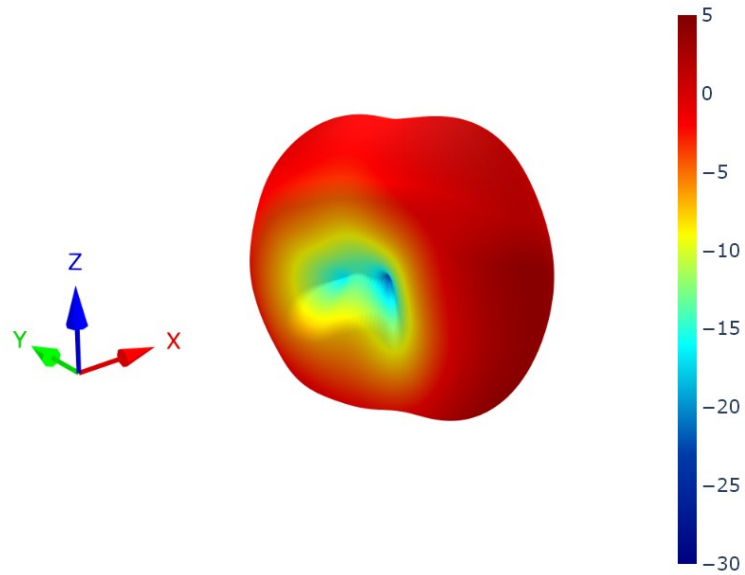

8.5 Antenna 4 Patterns at 1545 MHz

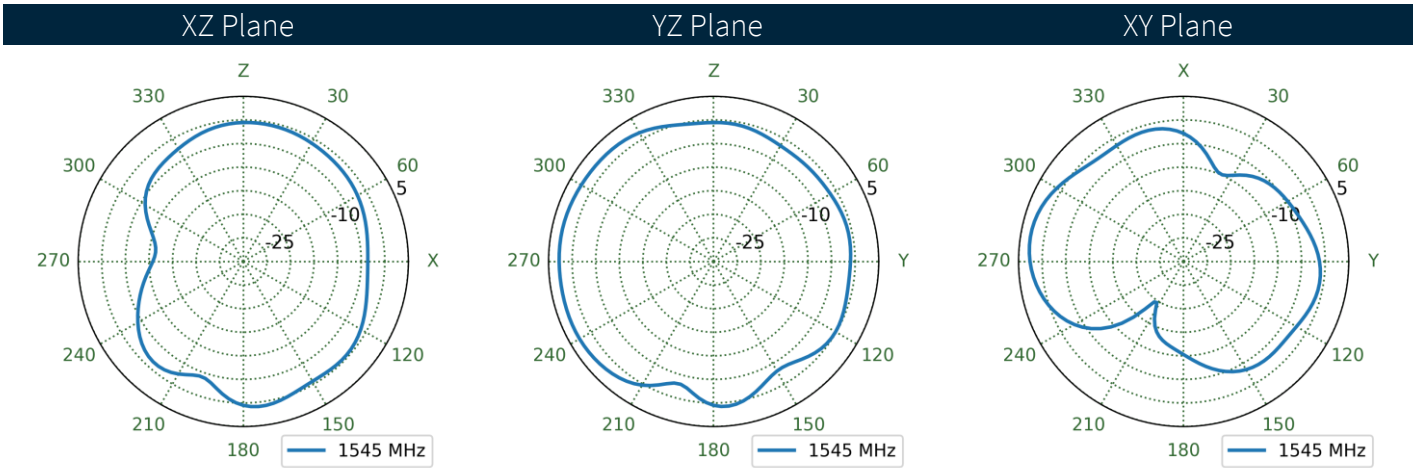
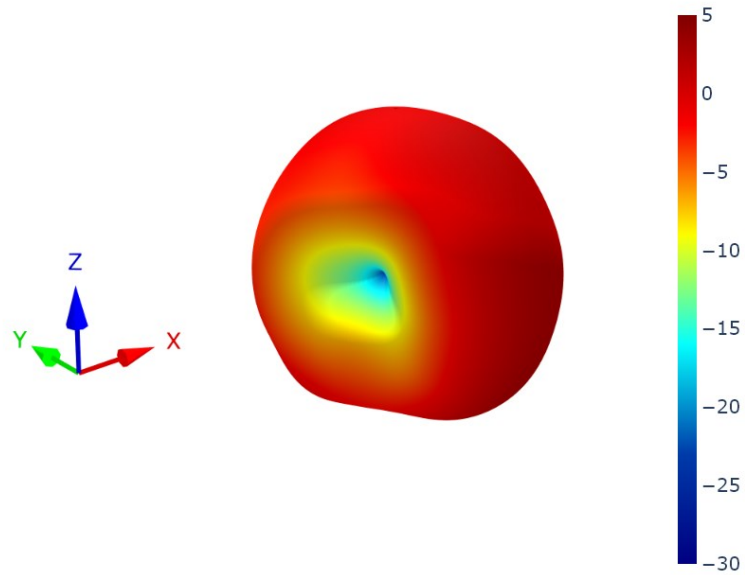

8.6 Antenna 1 Patterns at 1950 MHz

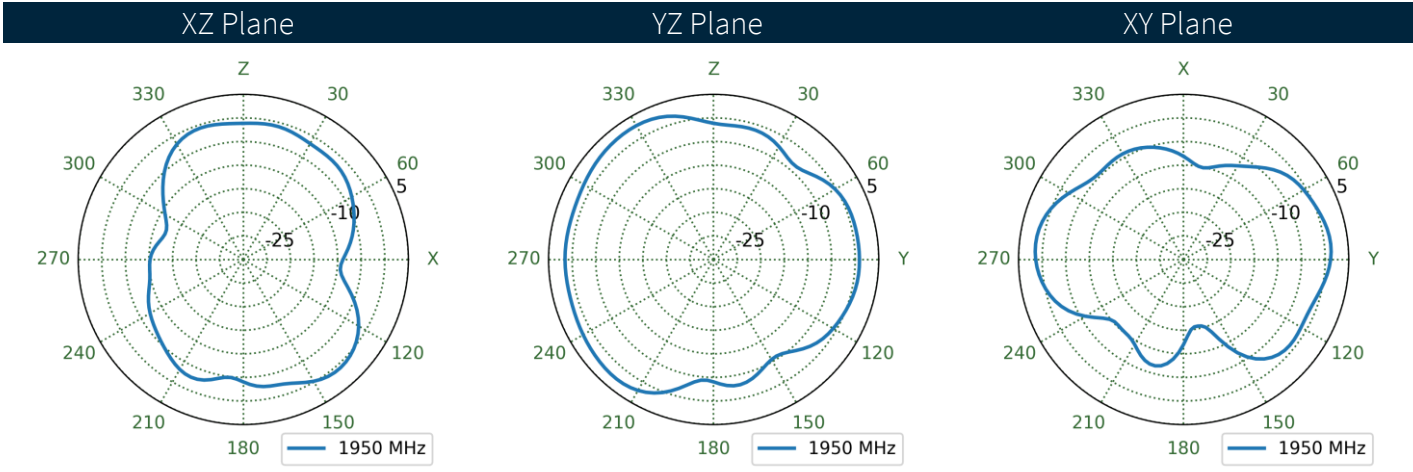
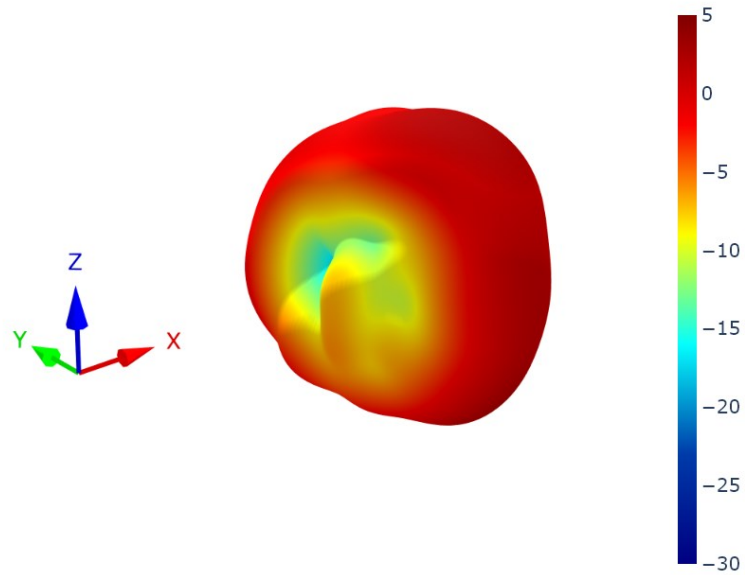

8.7 Antenna 2 Patterns at 1950 MHz

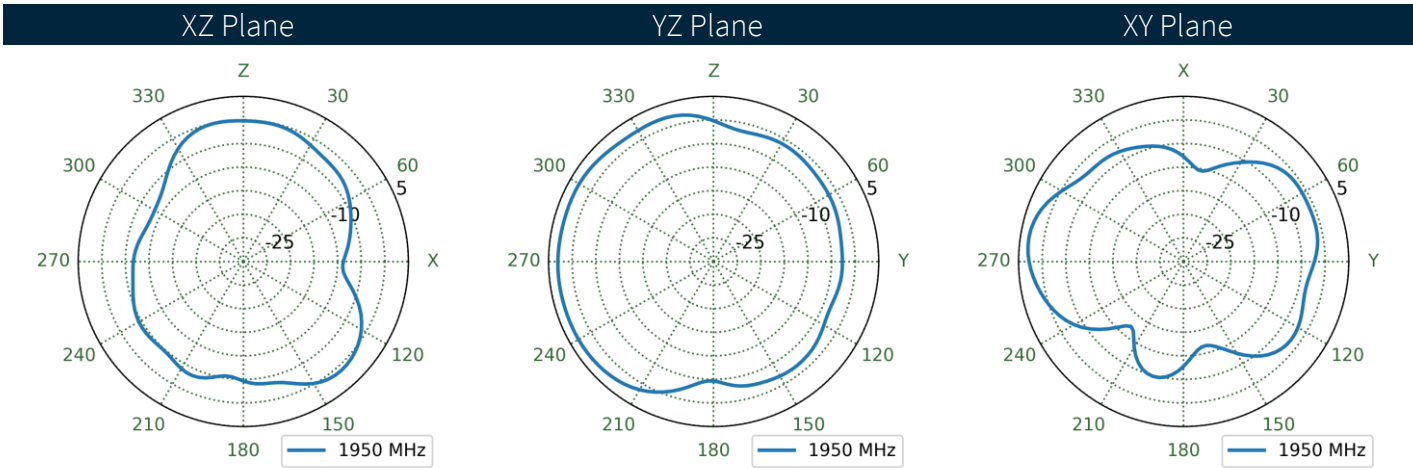
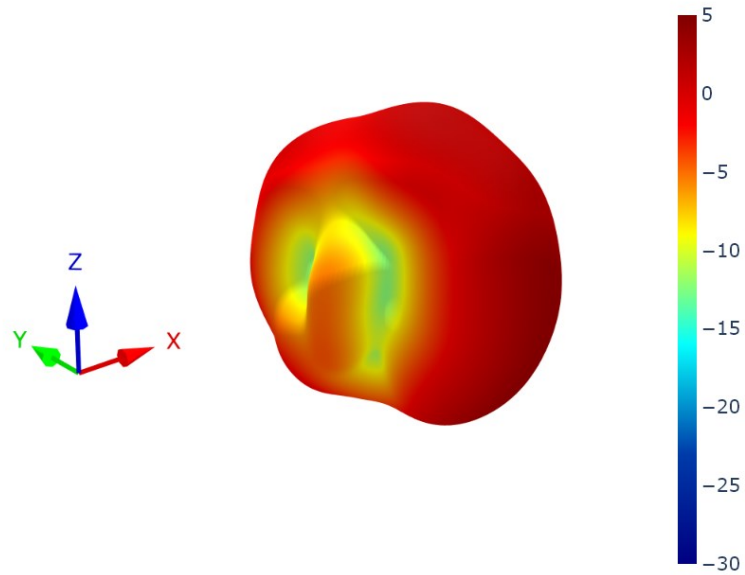

8.8 Antenna 3 Patterns at 1950 MHz

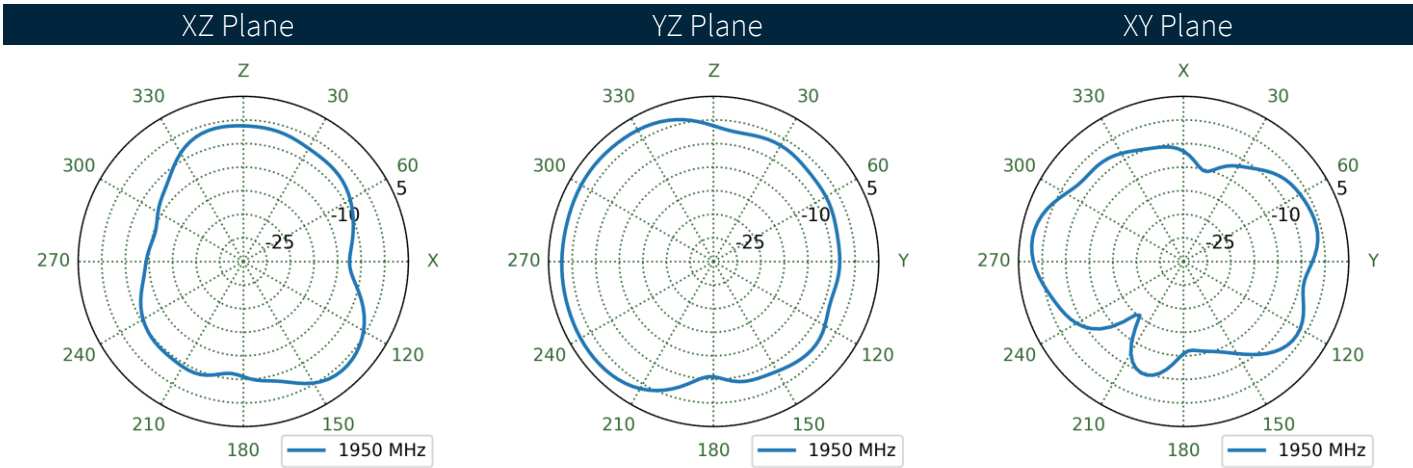
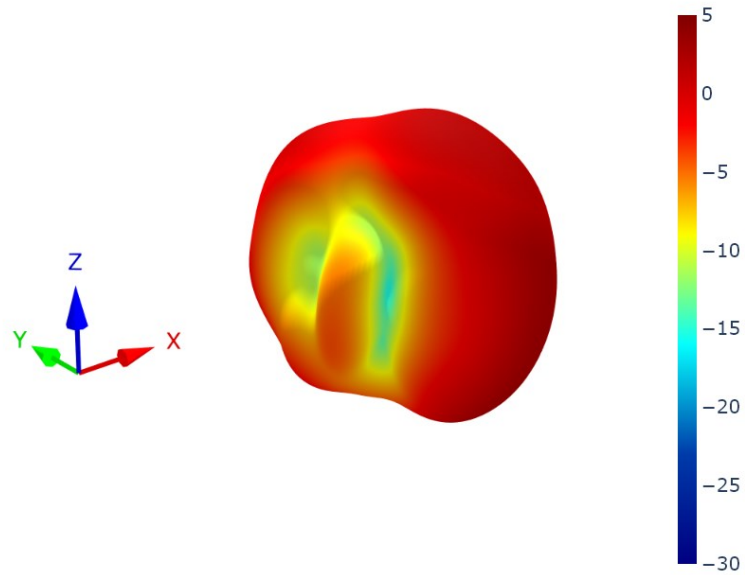

8.9 Antenna 4 Patterns at 1950 MHz

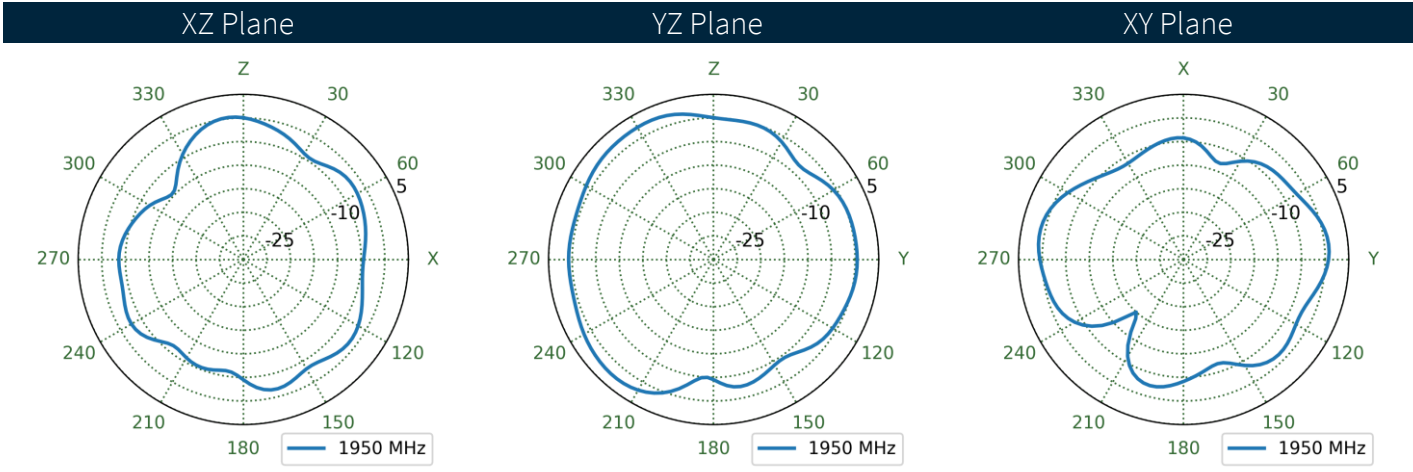
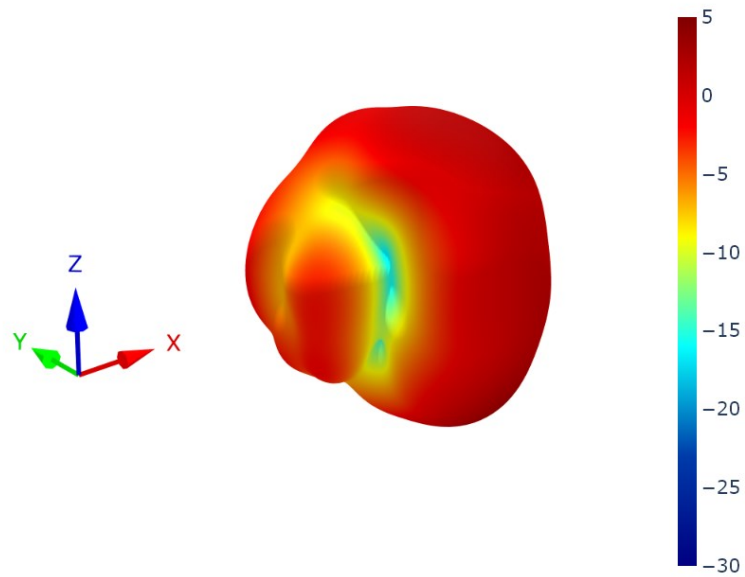

8.10 Antenna 1 Patterns at 2350 MHz

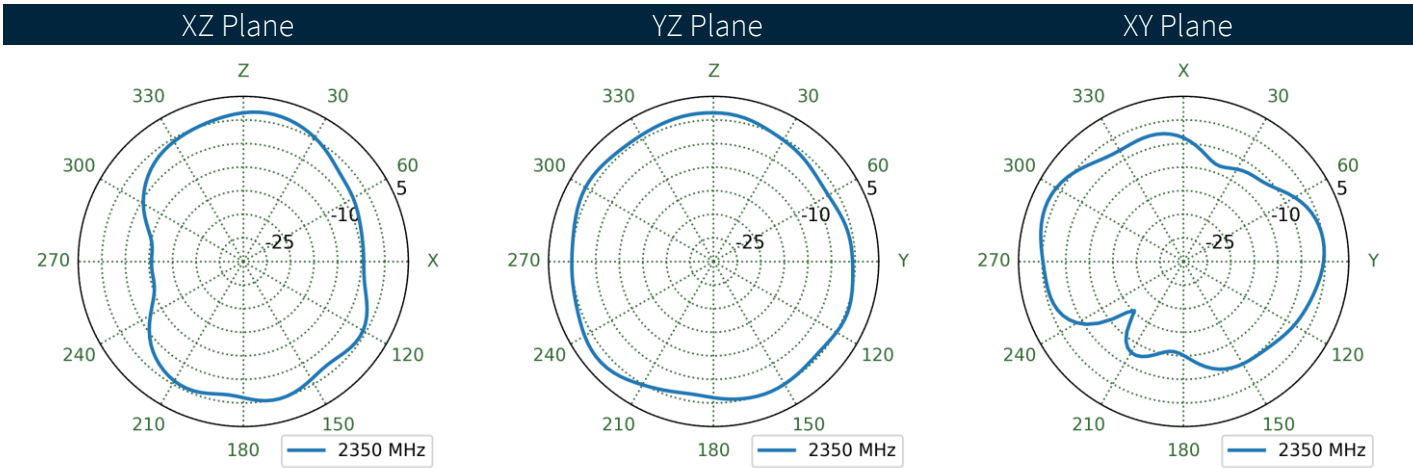
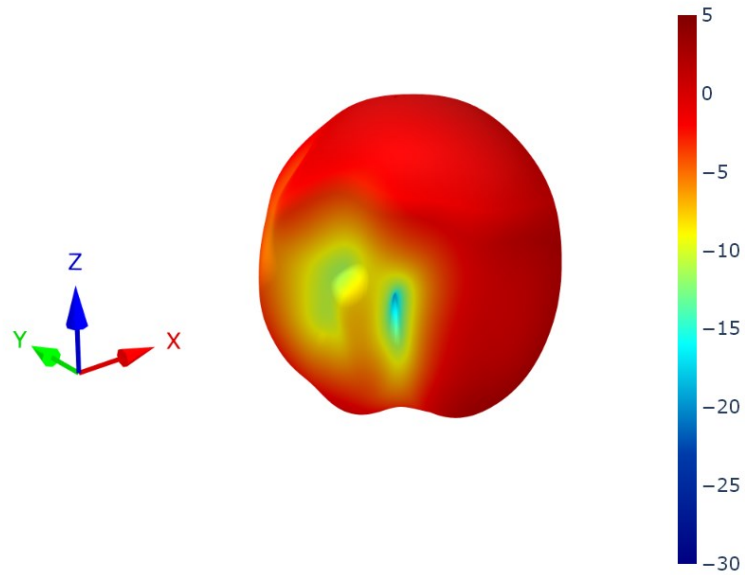

8.11 Antenna 2 Patterns at 2350 MHz

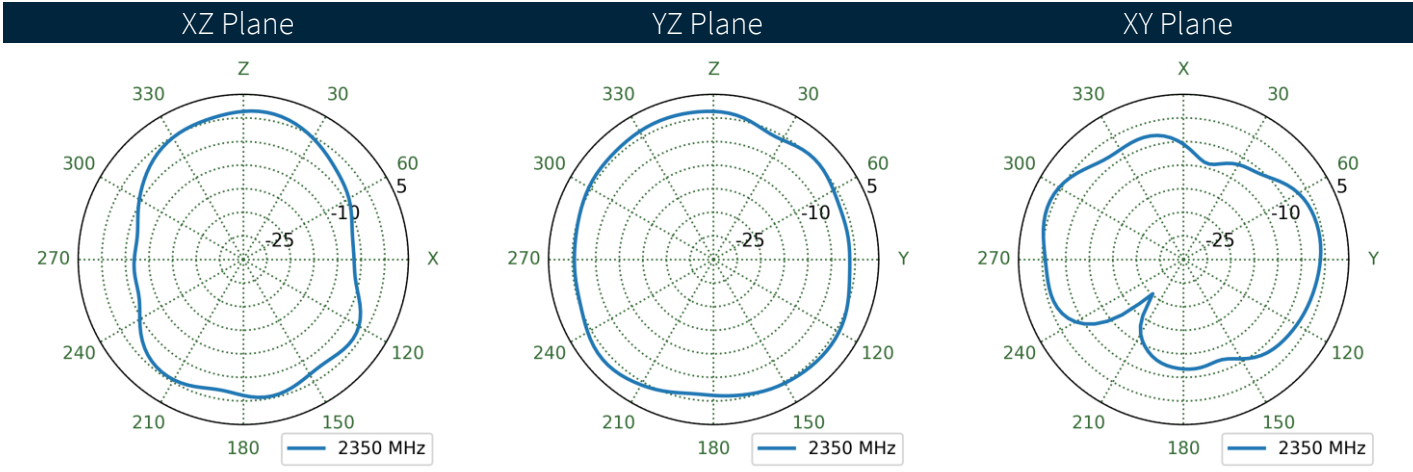
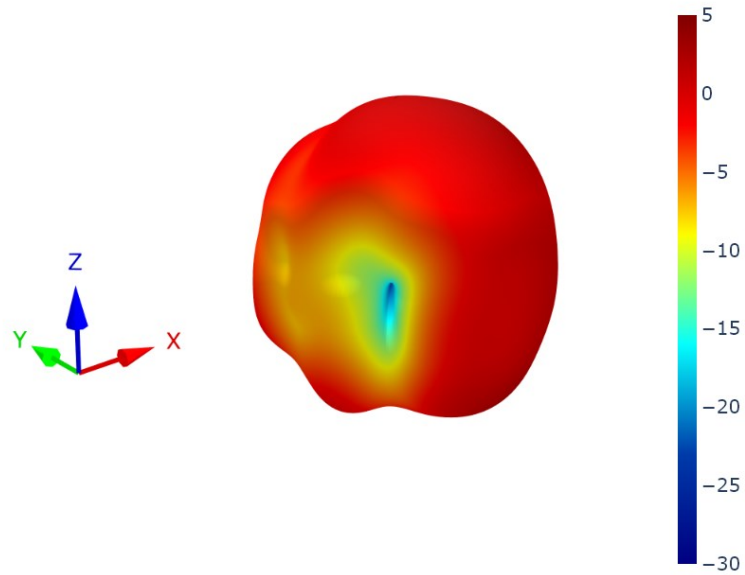

8.12 Antenna 3 Patterns at 2350 MHz

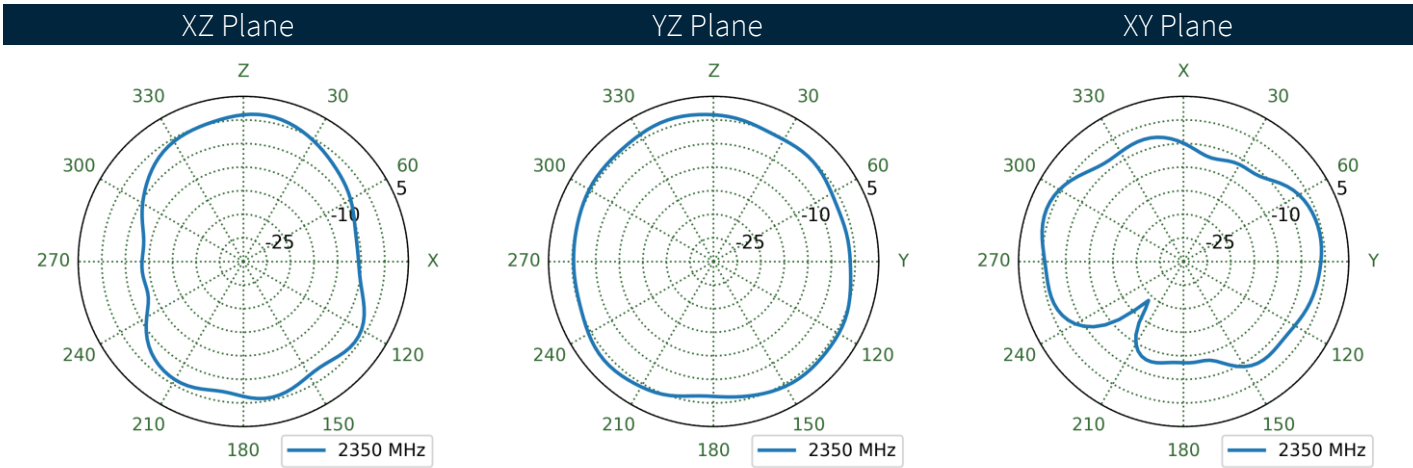
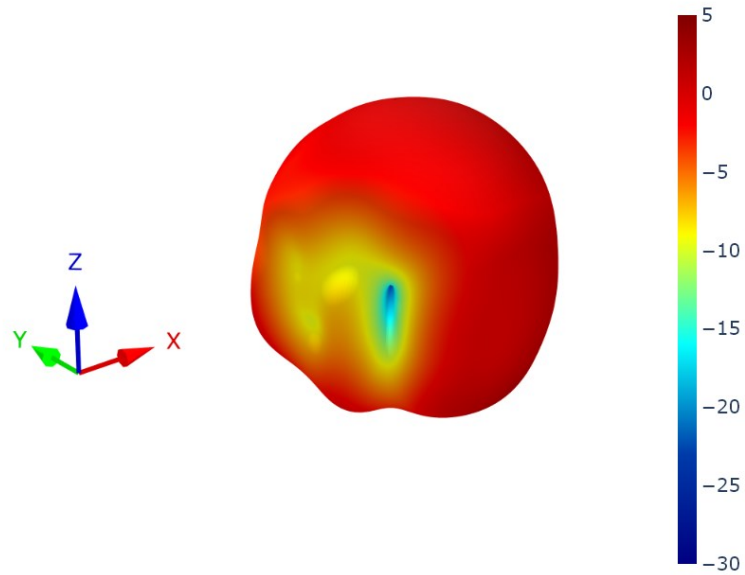

8.13 Antenna 4 Patterns at 2350 MHz

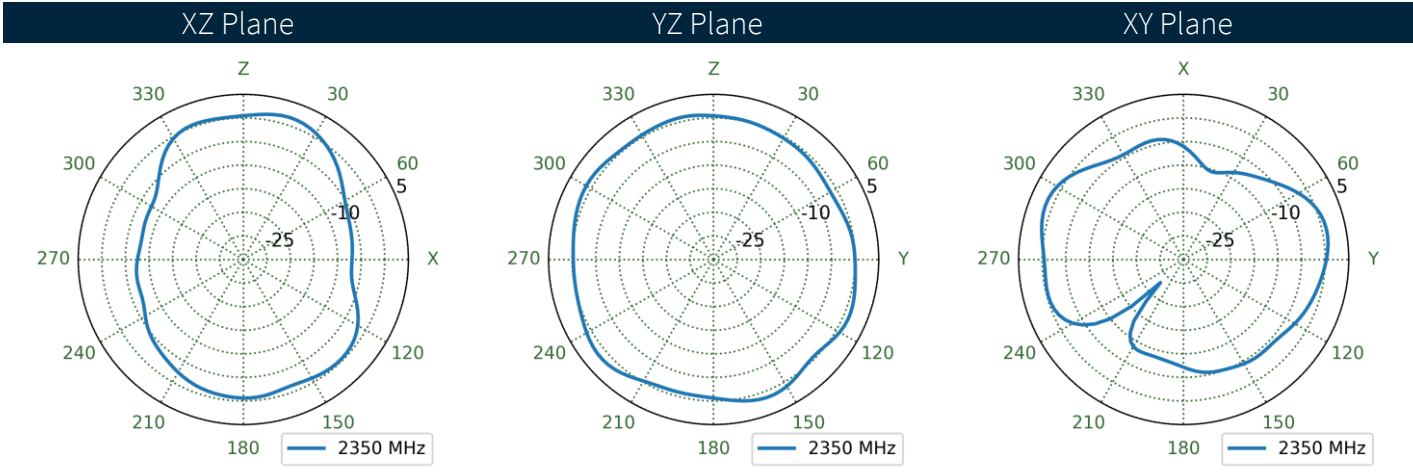
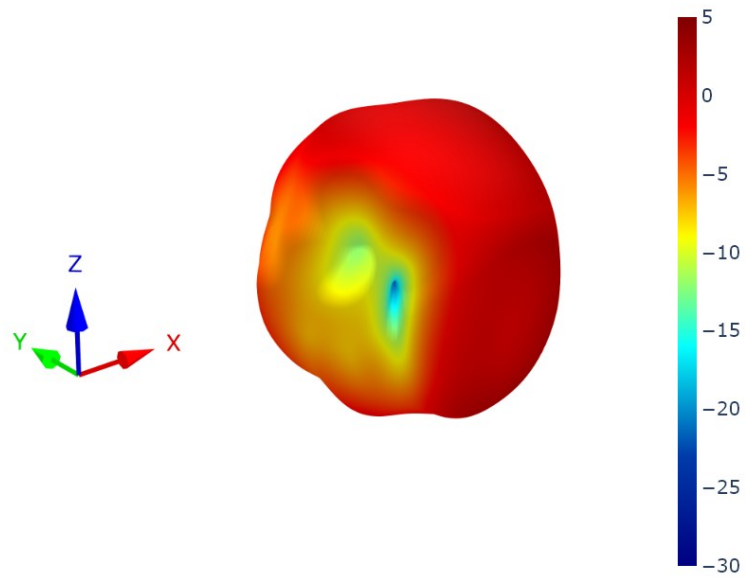

8.14 Antenna 1 Patterns at 2590 MHz

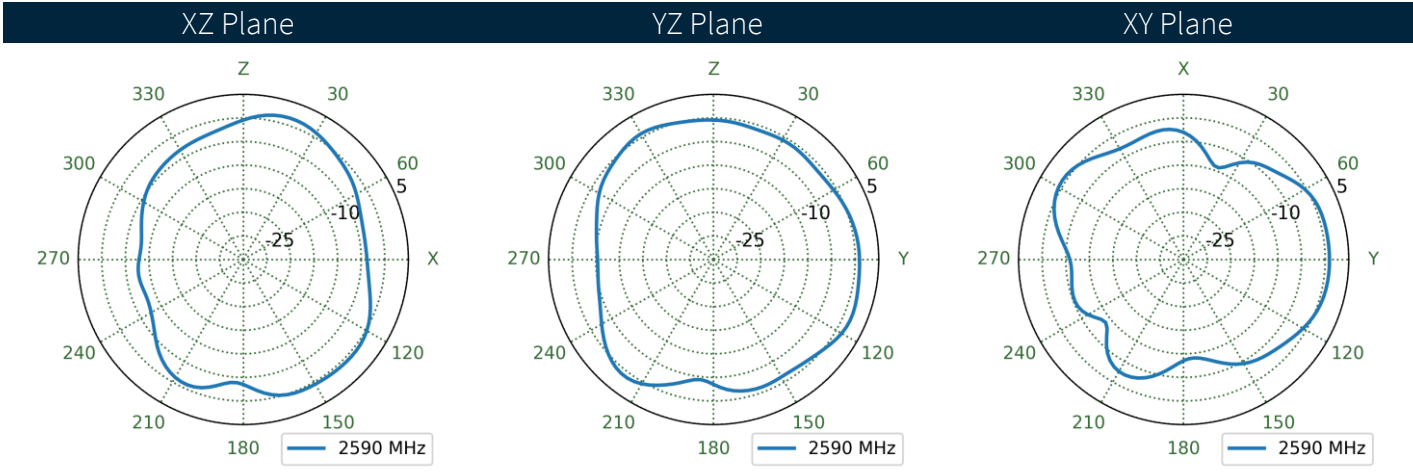
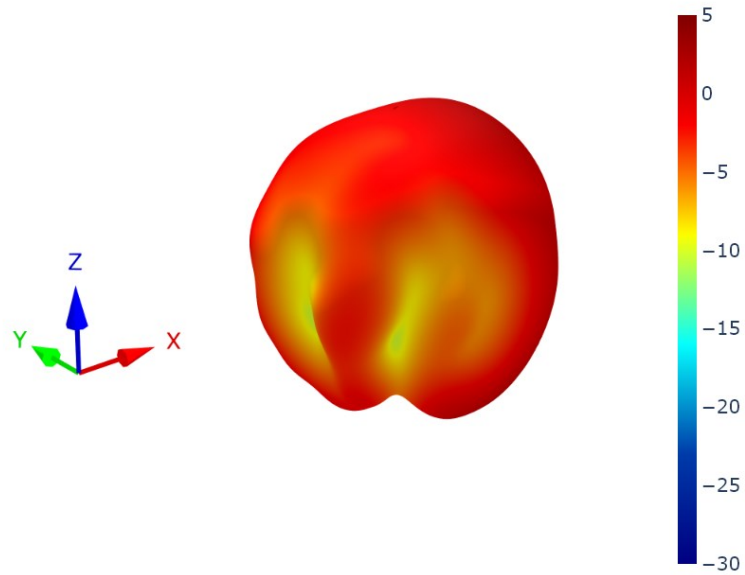

8.15 Antenna 2 Patterns at 2590 MHz

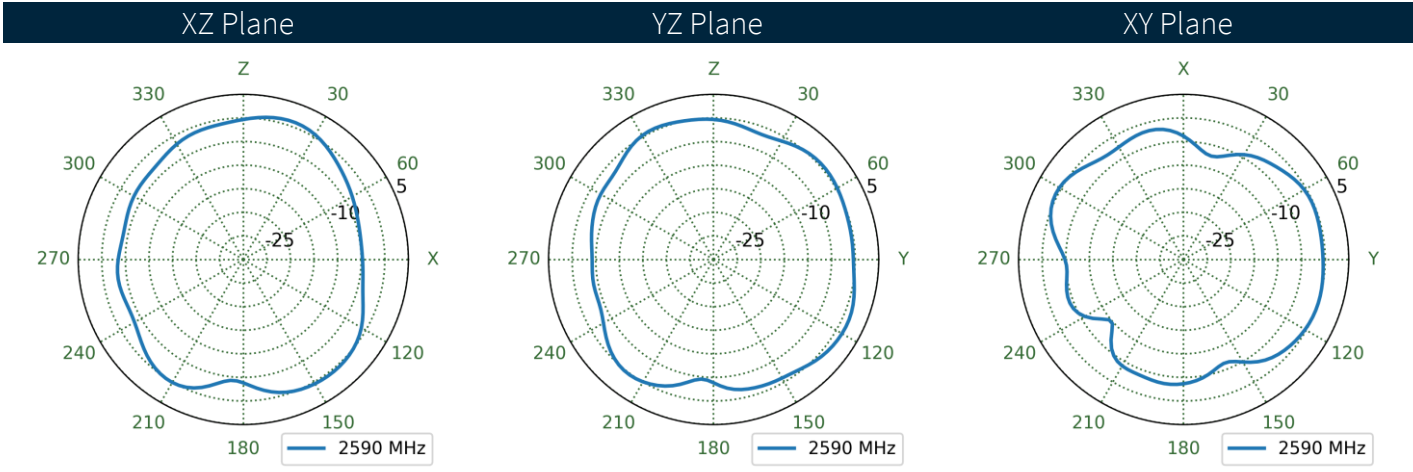
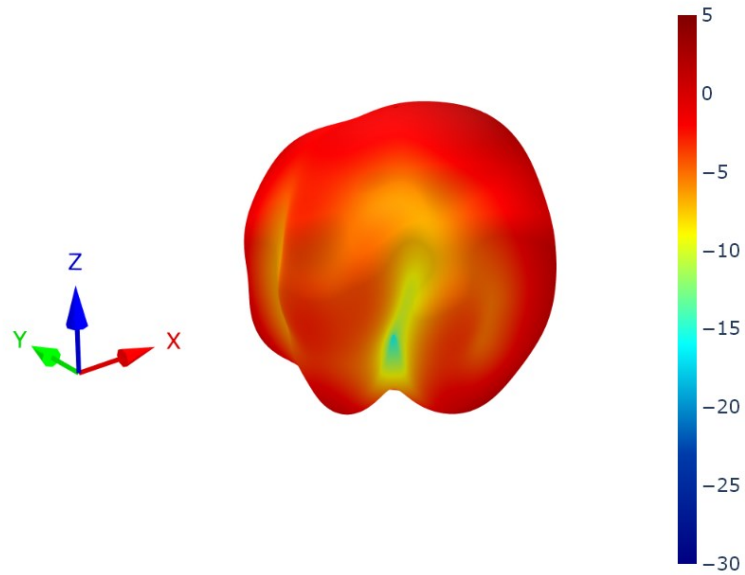

8.16 Antenna 3 Patterns at 2590 MHz

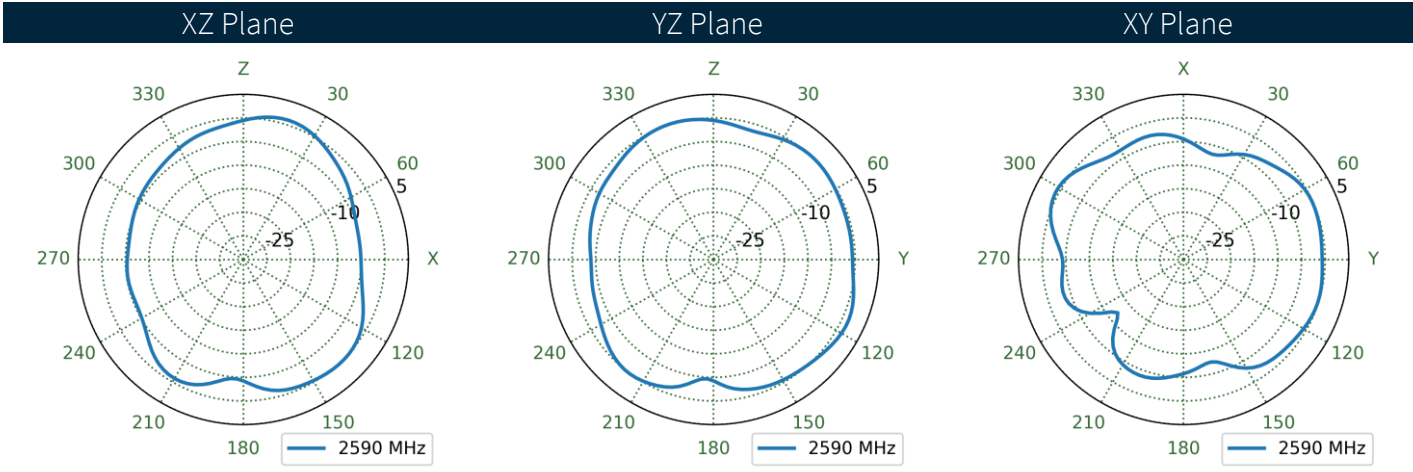
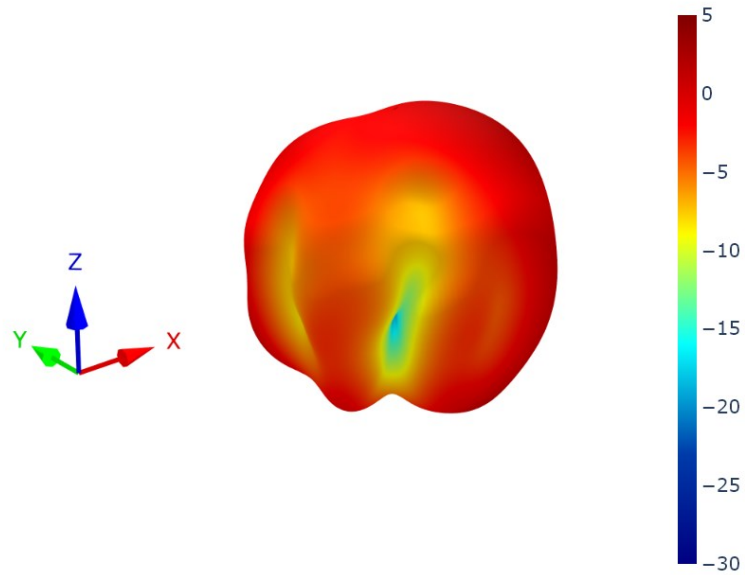

8.17 Antenna 4 Patterns at 2590 MHz

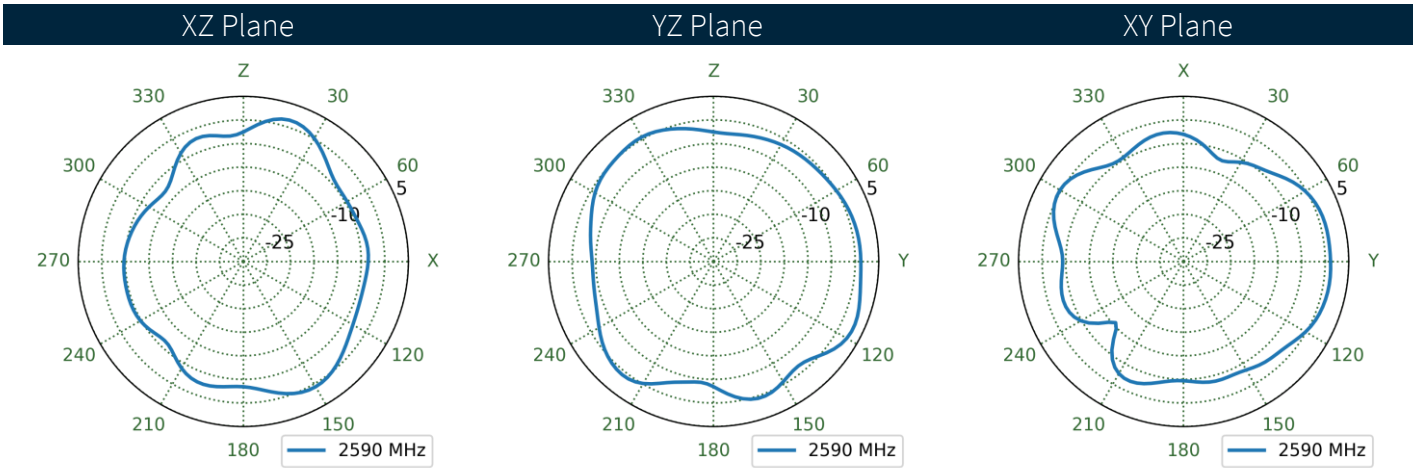
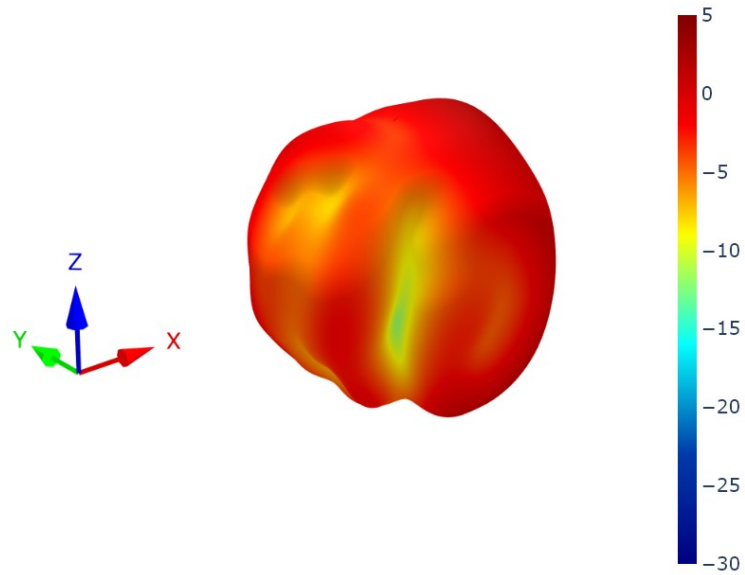

8.18 Antenna 1 Patterns at 3750 MHz

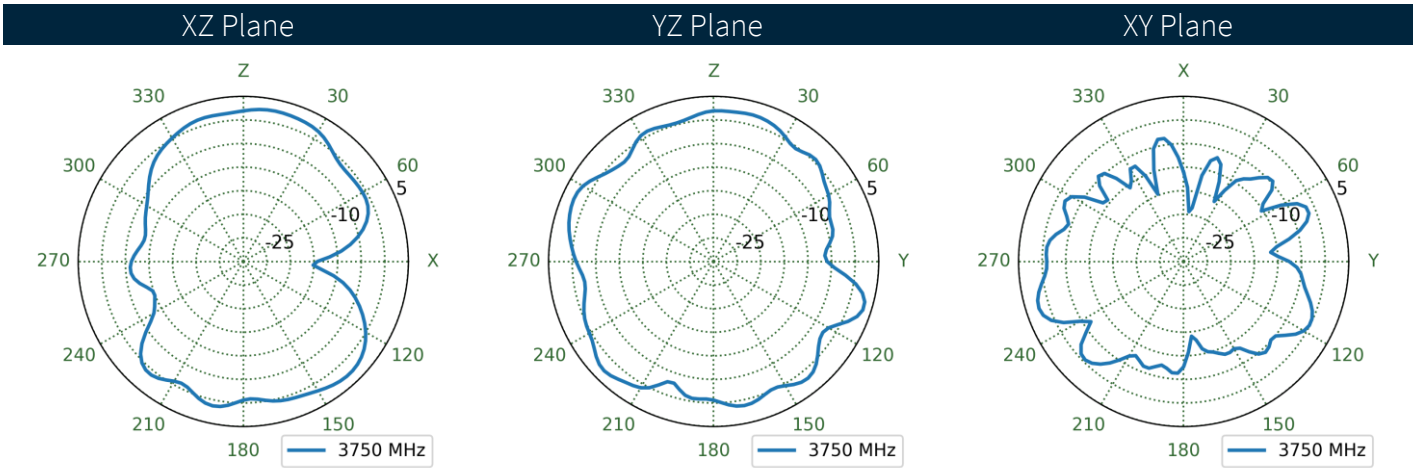
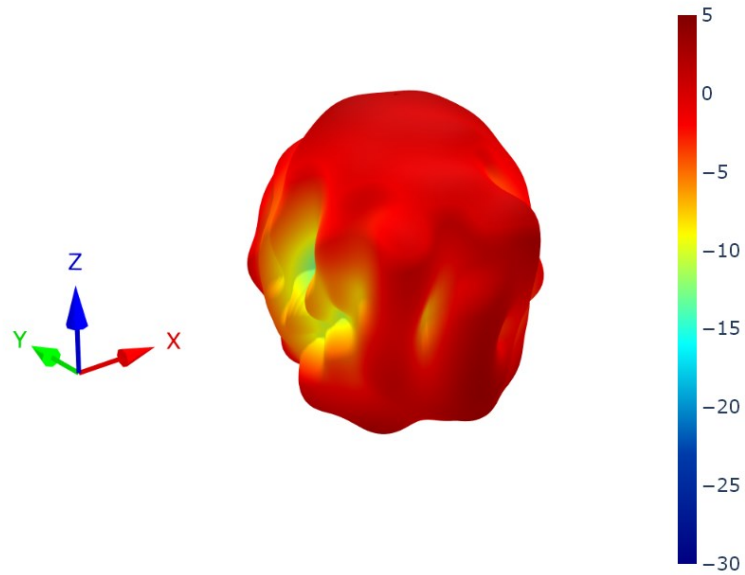

8.19 Antenna 2 Patterns at 3750 MHz

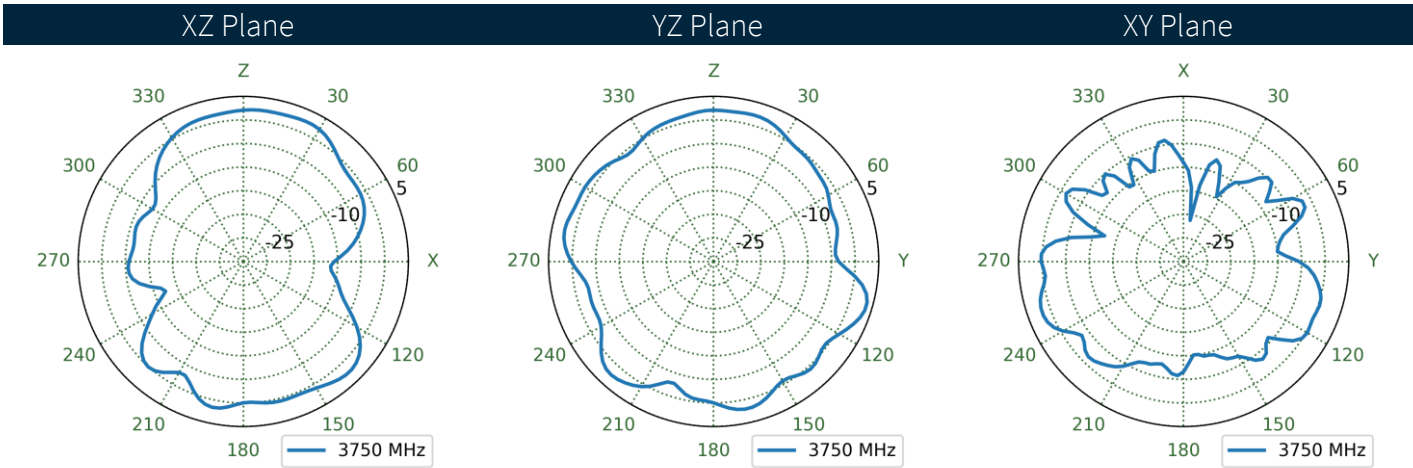
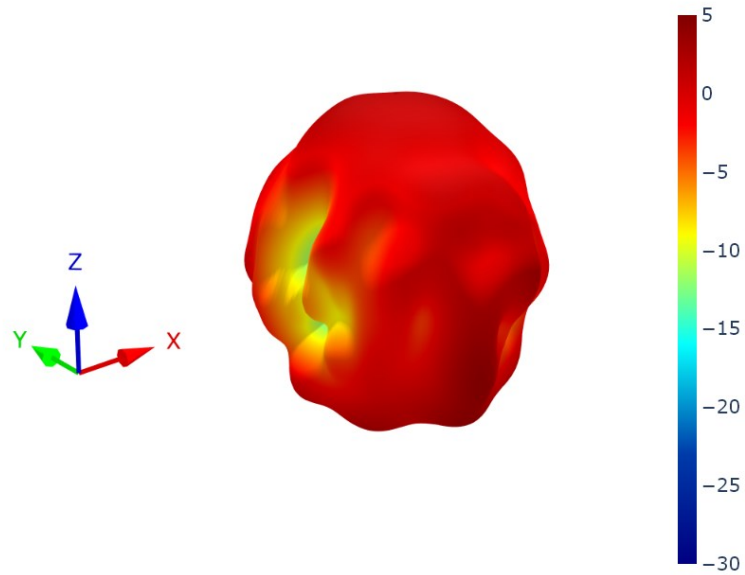

8.20 Antenna 3 Patterns at 3750 MHz

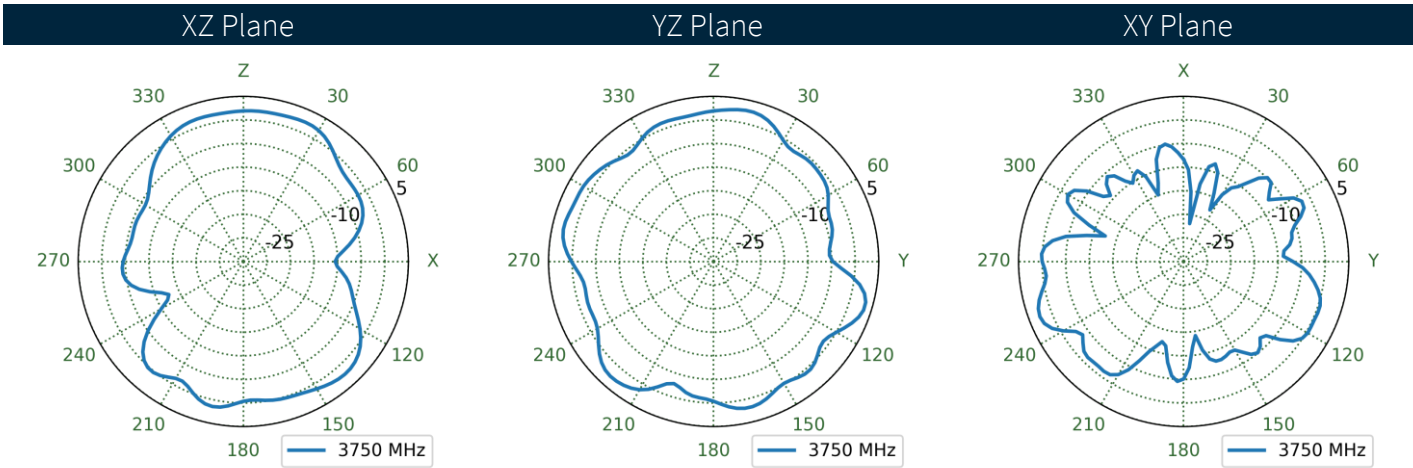
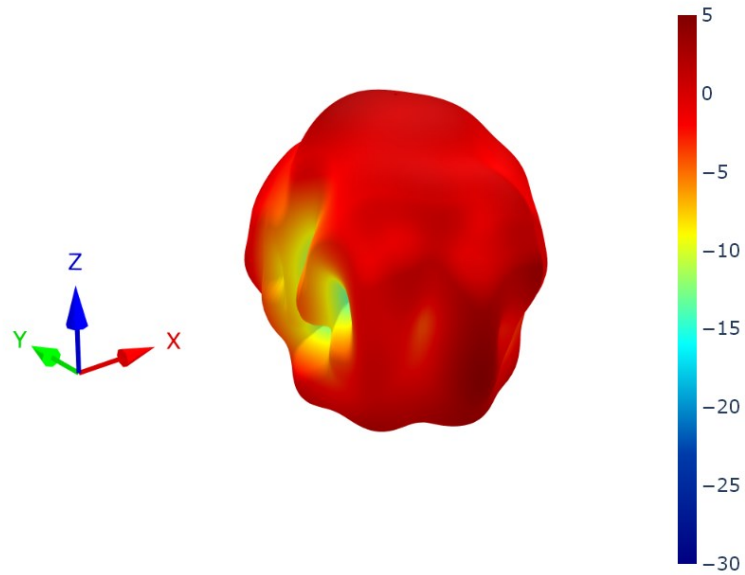

8.21 Antenna 4 Patterns at 3750 MHz

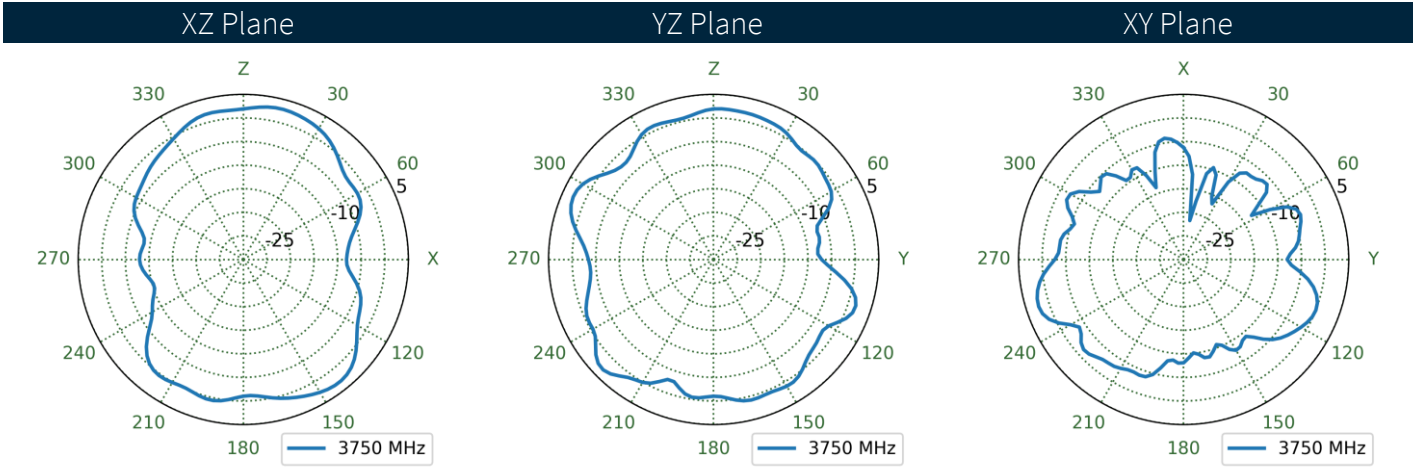
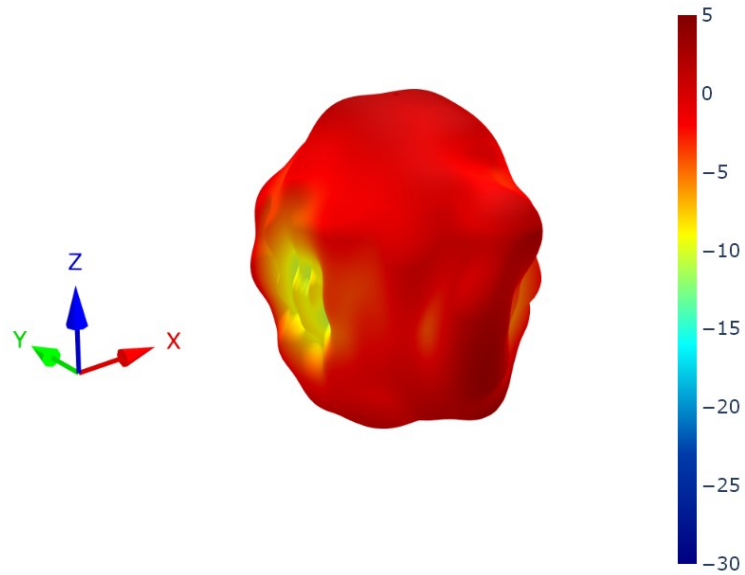

8.22 Antenna 1 Patterns at 4700 MHz

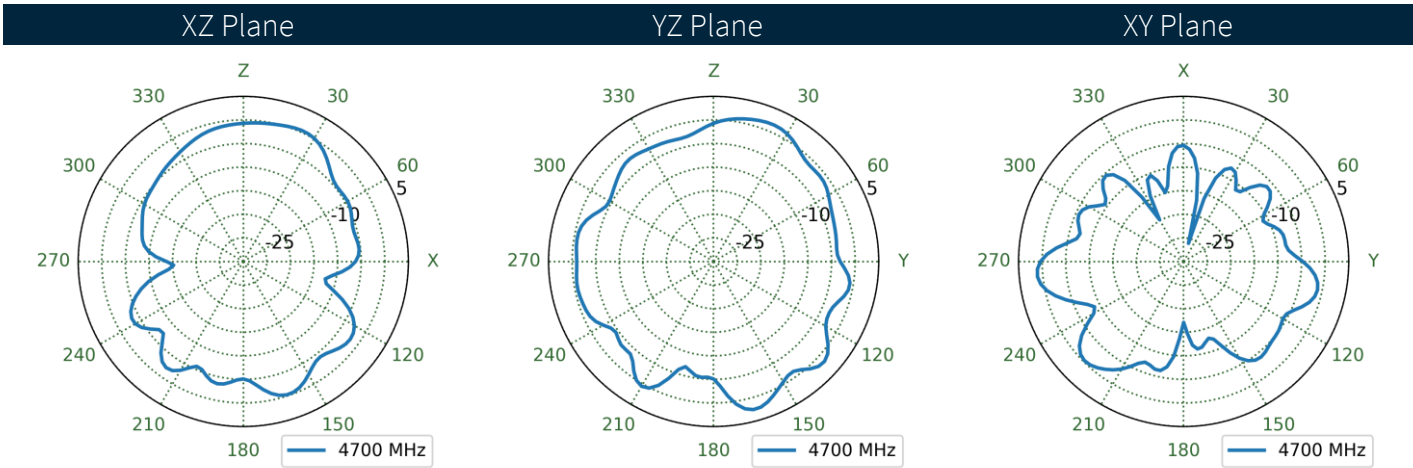
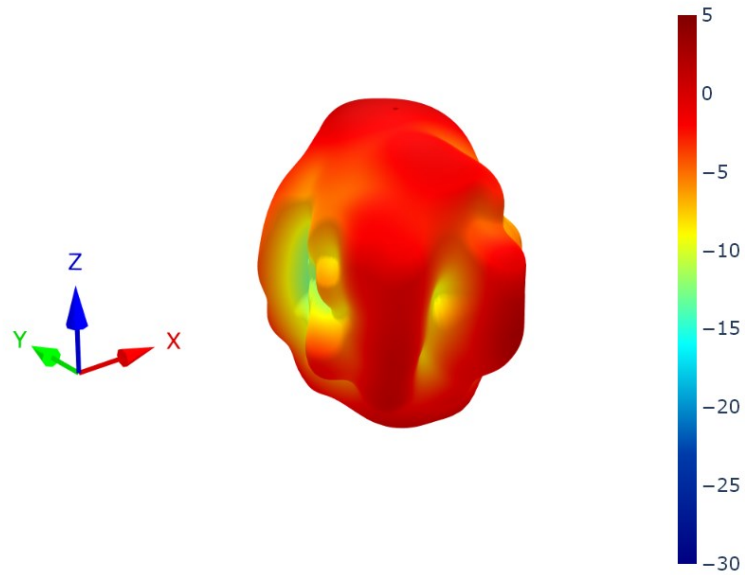

8.23 Antenna 2 Patterns at 4700 MHz

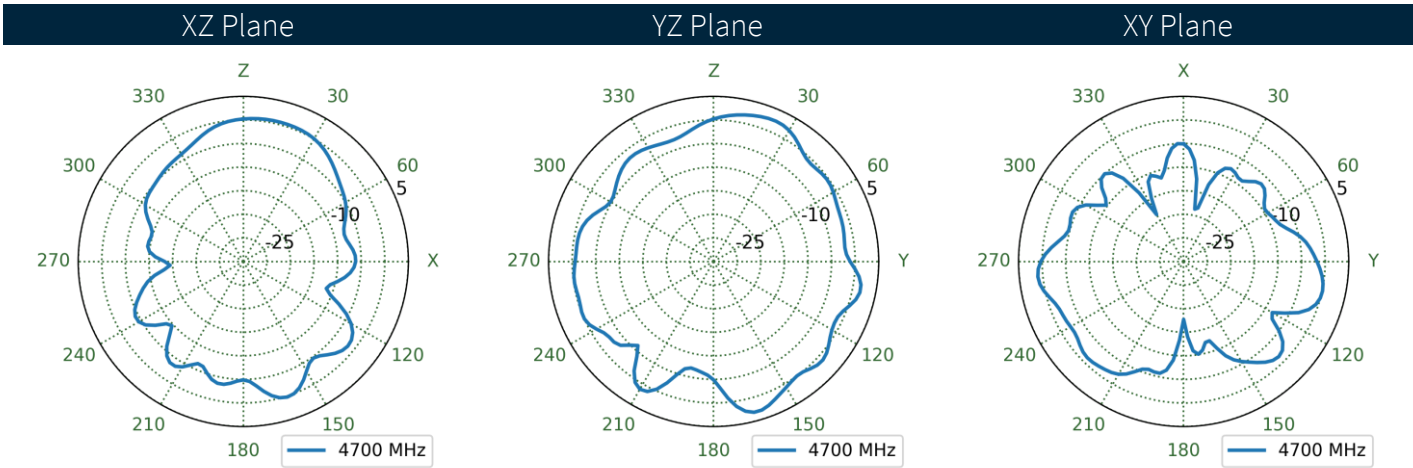
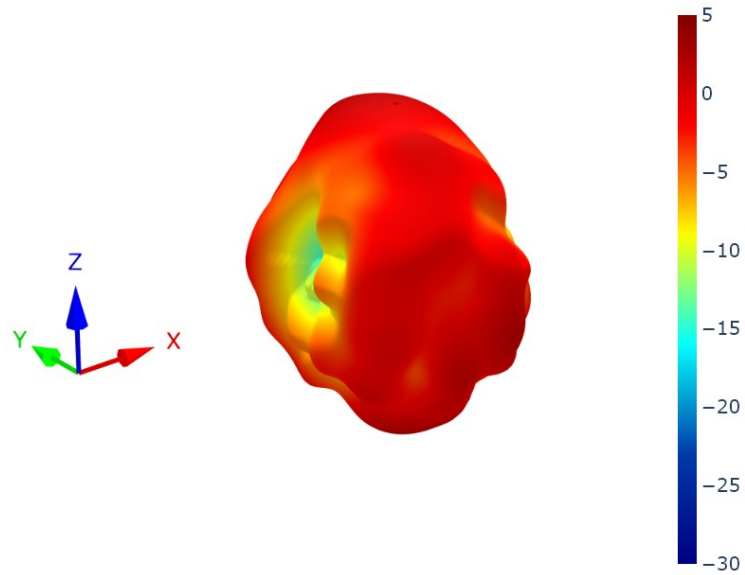

8.24 Antenna 3 Patterns at 4700 MHz

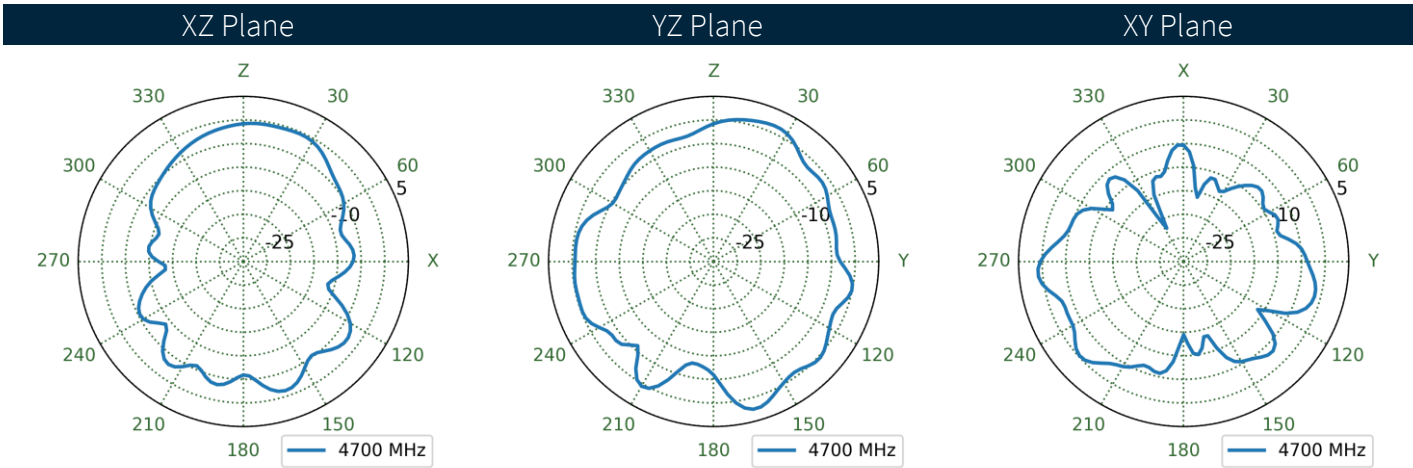
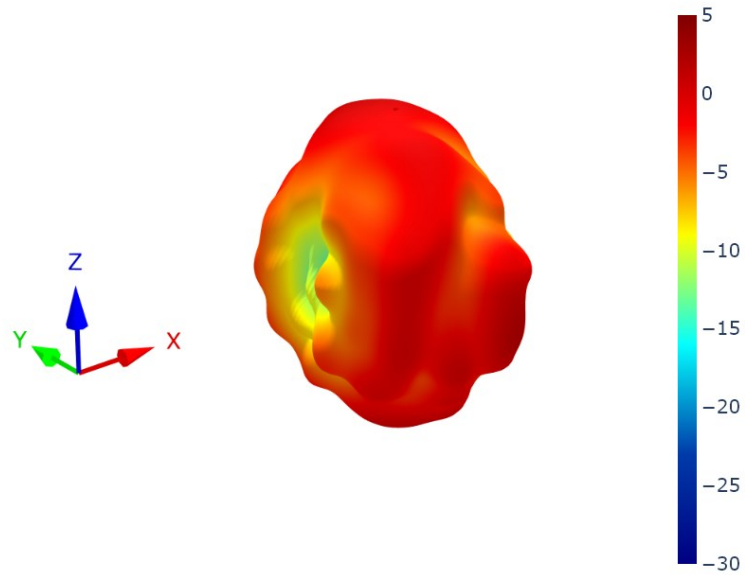

8.25 Antenna 4 Patterns at 4700 MHz

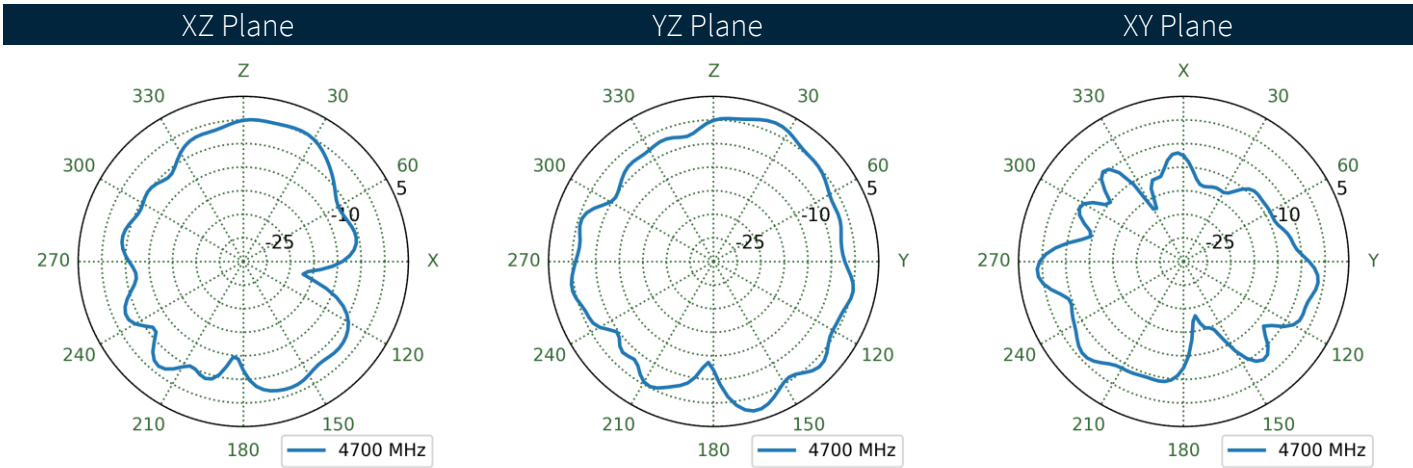
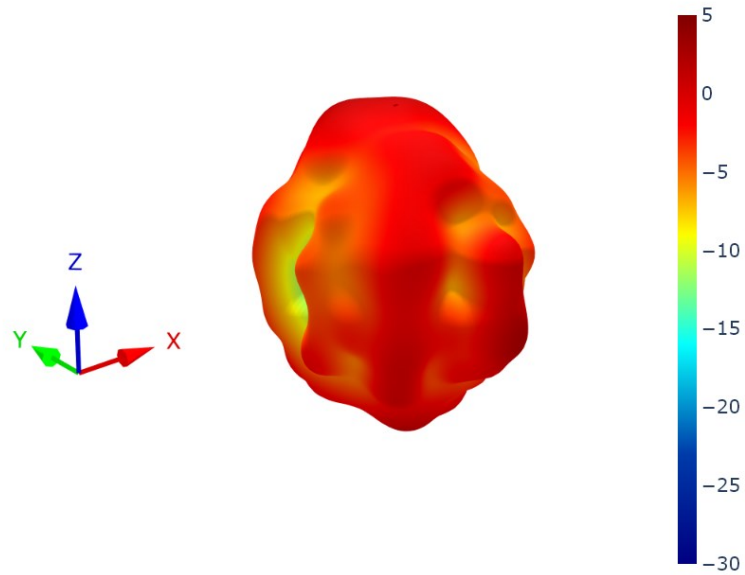

8.26 Antenna 1 Patterns at 5550 MHz

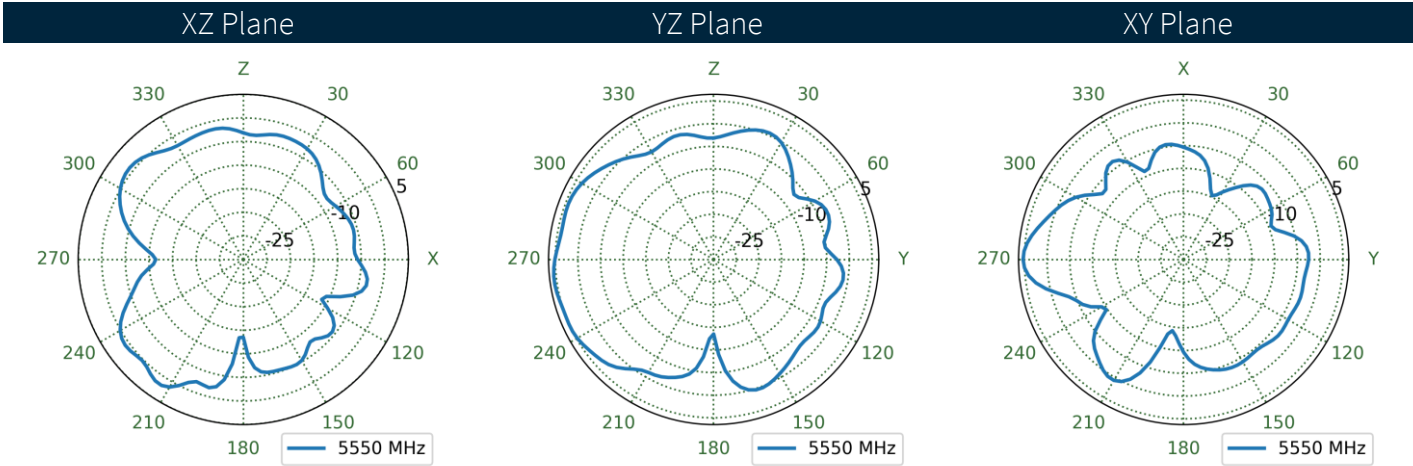
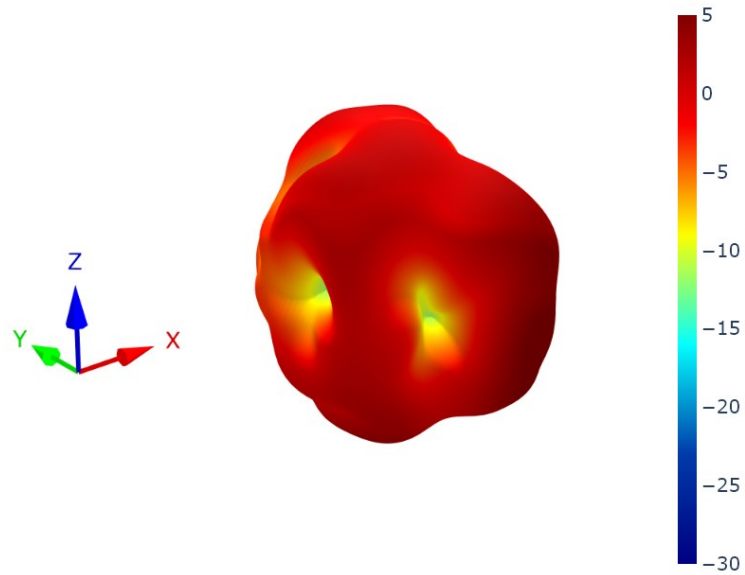

8.27 Antenna 2 Patterns at 5550 MHz

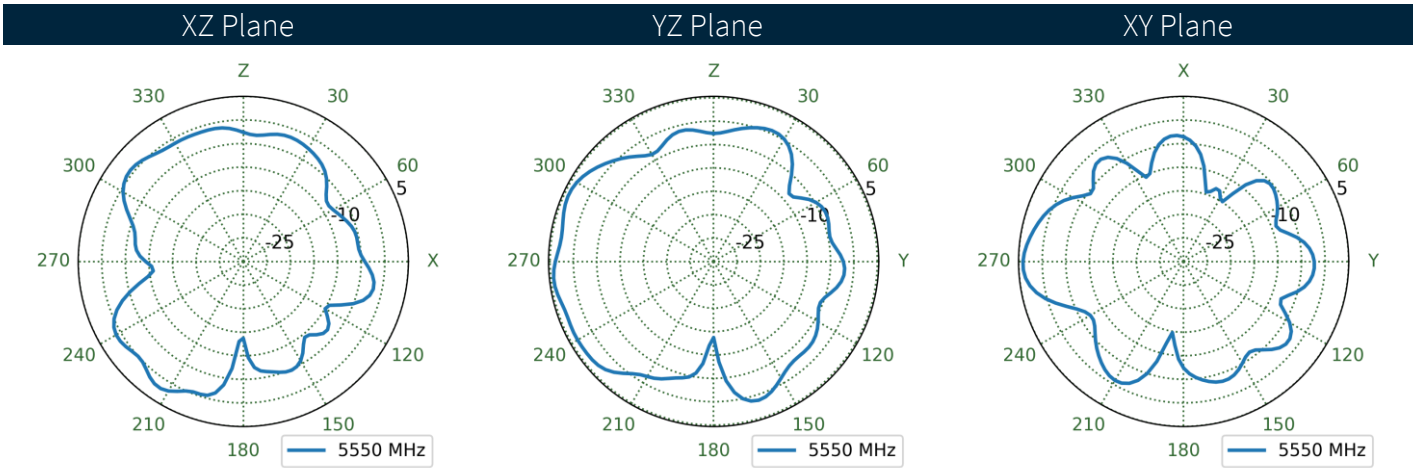
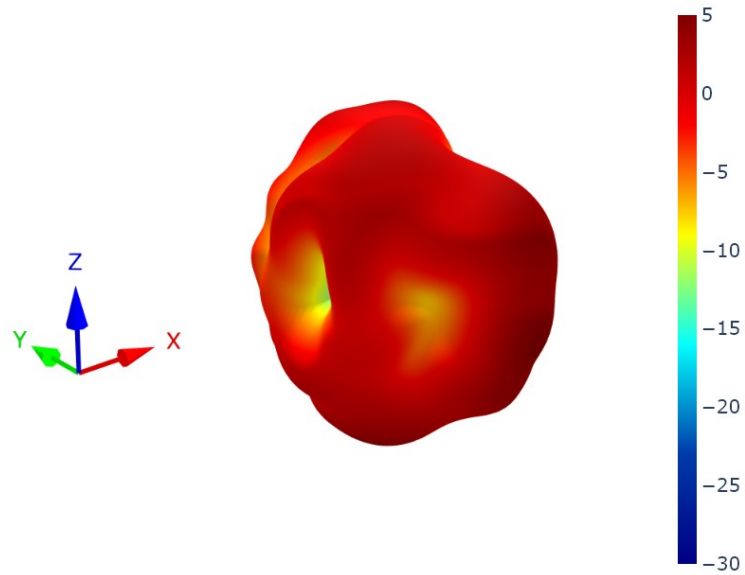

8.28 Antenna 3 Patterns at 5550 MHz

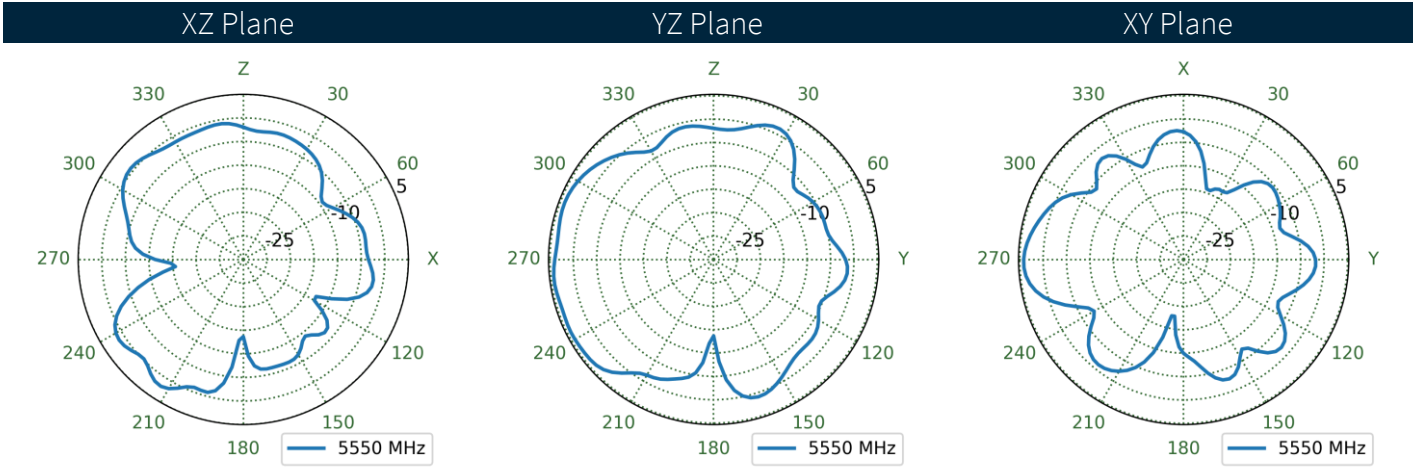
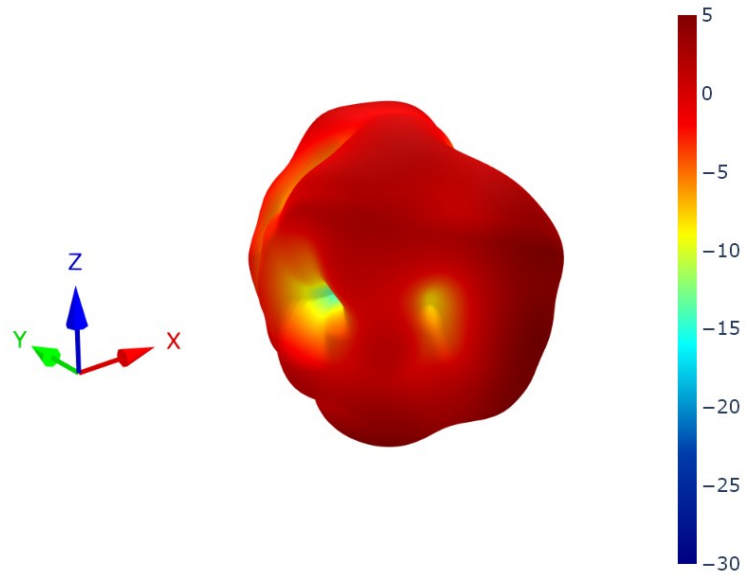

8.29 Antenna 4 Patterns at 5550 MHz

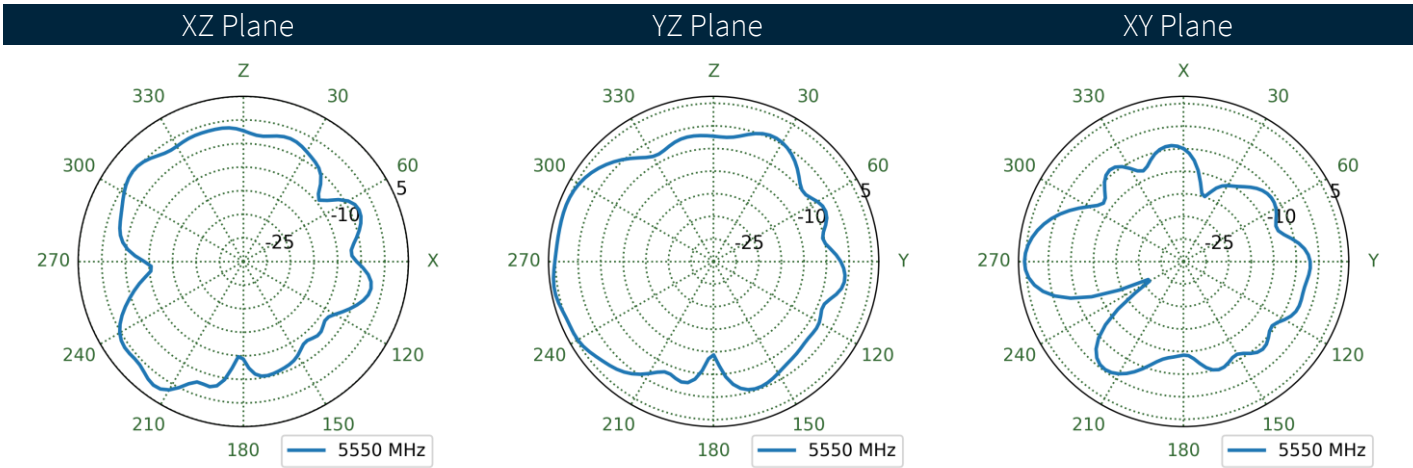
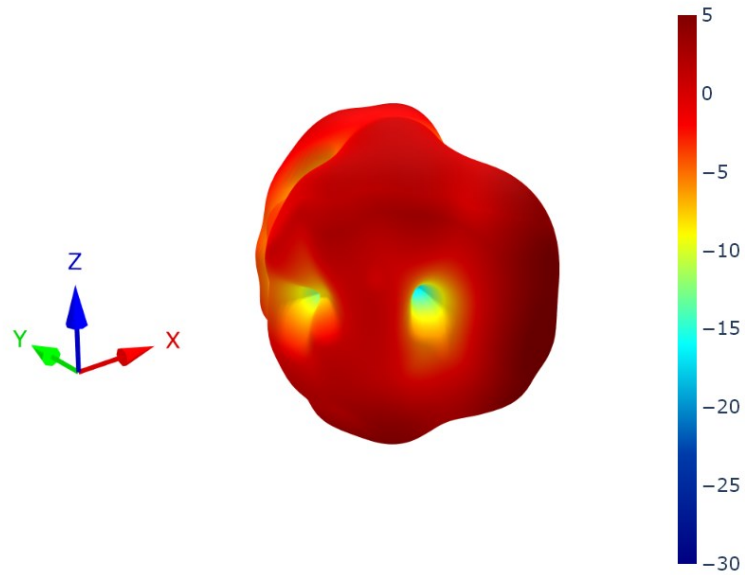

Changelog for the datasheet

SPE-24-8-075 – FXUB52.A.07.C.001

Revision: A (Original First Release)

Date: 2024-04-23

Notes: Initial Release.

Author: Gary West

Previous Revisions



www.taoglas.com



Mouser Electronics

Authorized Distributor

Click to View Pricing, Inventory, Delivery & Lifecycle Information:

[Taoglas:](#)

[FXUB52.A.07.C.001](#)