



TAOGLAS®



Datasheet

Part No:
CGGP.35.3.A.02

Description:
3.5mm height GPS/GLONASS/Galileo
Patch Antenna 1575/1610MHz

Features:
Wide-band Operation
35mm*35mm*3.5mm
4dBi Peak Gain (on 50mm*50mm ground-plane)
85% Efficiency (on 50mm*50mm ground-plane)
Pin type
Automotive TS16949 Production and Quality Approved
RoHS & Reach Compliant

| | | |
|-------|-------------------------------------|----|
| 1. | Introduction | 3 |
| 2. | Specifications | 4 |
| 3. | Antenna Test Setup | 5 |
| 3. | Antenna Characteristics | 6 |
| 4. | Antenna Radiation Pattern | 8 |
| 5. | Axial Ratio | 10 |
| 6. | Mechanical Drawing | 11 |
| 7. | PCB Footprint Recommendation | 13 |
| 8. | Antenna Integration Guide | 14 |
| 8. | Evaluation Board Mechanical Drawing | 19 |
| 9. | Packaging | 20 |
| <hr/> | | |
| | Changelog | 21 |

Taoglas makes no warranties based on the accuracy or completeness of the contents of this document and reserves the right to make changes to specifications and product descriptions at any time without notice. Taoglas reserves all rights to this document and the information contained herein. Reproduction, use or disclosure to third parties without express permission is strictly prohibited.



1. Introduction



The Taoglas 35mm ceramic GPS/GLONASS/GALILEO patch antenna, by means of a double resonance design, has unique wide-band operation over the whole operating bands of GPS/GLONASS/Galileo systems spanning from 1575MHz to 1610MHz. It is mounted via pin and double-sided adhesive. This antenna has been tuned for a center position on a 50mm*50mm ground-plane. It is manufactured and tested in a TS16949 first tier automotive approved facility.

For further optimization to customer specific device environments where positioning is off center or on different ground-plane sizes, custom tuned patch antennas can be supplied. Taoglas can also provide different pin lengths for these antennas, subject to potential NRE and MOQ. For more details please contact your regional Taoglas customer support team.

2. Specifications

| Electrical | | |
|--|-------------------|-----------|
| Application Bands | GPS/Galileo | GLONASS |
| Operation Frequency | 1575.42 ±1.023MHz | 1602±5MHz |
| Bandwidth | 22MHz min | |
| VSWR | 1.5 | |
| Peak Gain | 4.0dBi typ. | |
| Gain at Zenith | 4.0dBi | |
| Gain at 10°elevation | 1.5dBi typ. | |
| Axial Ratio | 3dB max | |
| Impedance | 50 Ohms | |
| Efficiency | 85% typ. | |
| Frequency Temperature Coefficient (τf) | 0 ± 20ppm / oC | |
| Mechanical | | |
| Ceramic Dimension | 35*35*3.5mm | |
| Pin Length | 2.4mm | |
| Pin Diameter | 0.9mm | |
| Environmental | | |
| Storage Temperature | -40°C to +85°C | |
| Operating Temperature | -40°C to +85°C | |

* Antenna properties were measured with the antenna mounted on 50*50mm Ground Plane

3. Antenna Test Setup

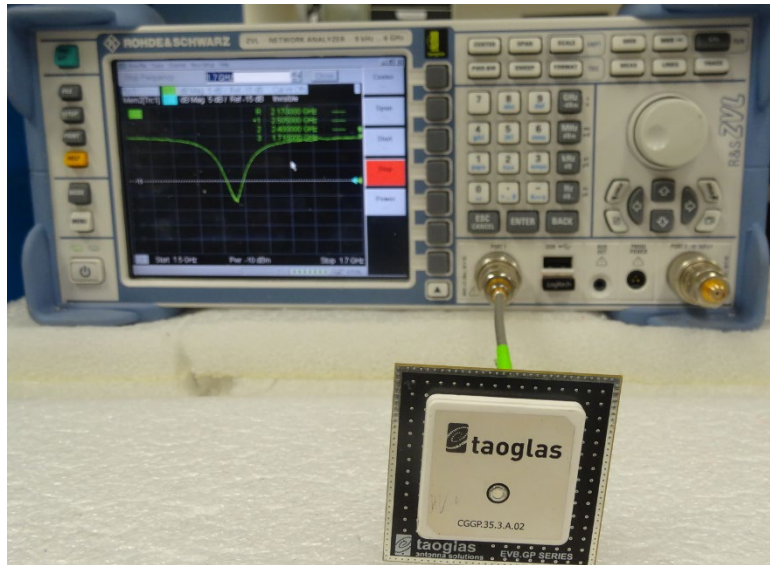

Return Loss measurement of the CGGP.35.3.A.02

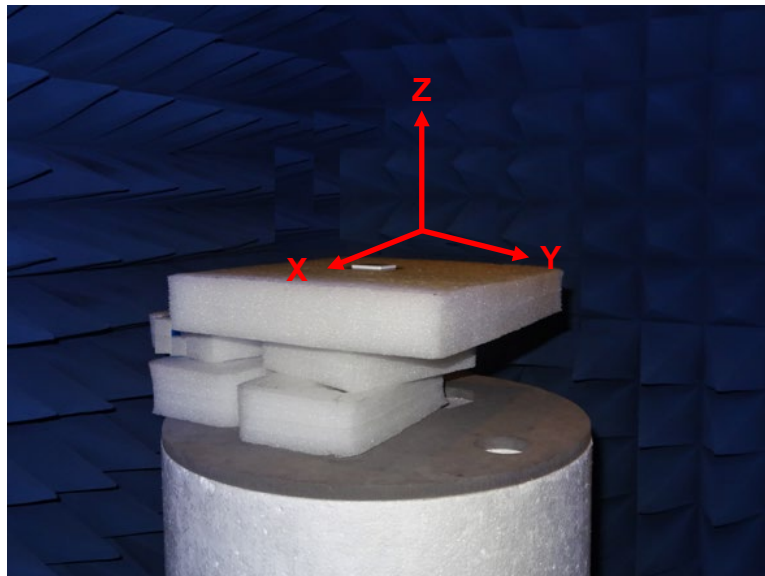

Peak gain, efficiency and radiation pattern measurements of the CGGP.35.3.A.02

4. Antenna Characteristics

4.1 Return Loss

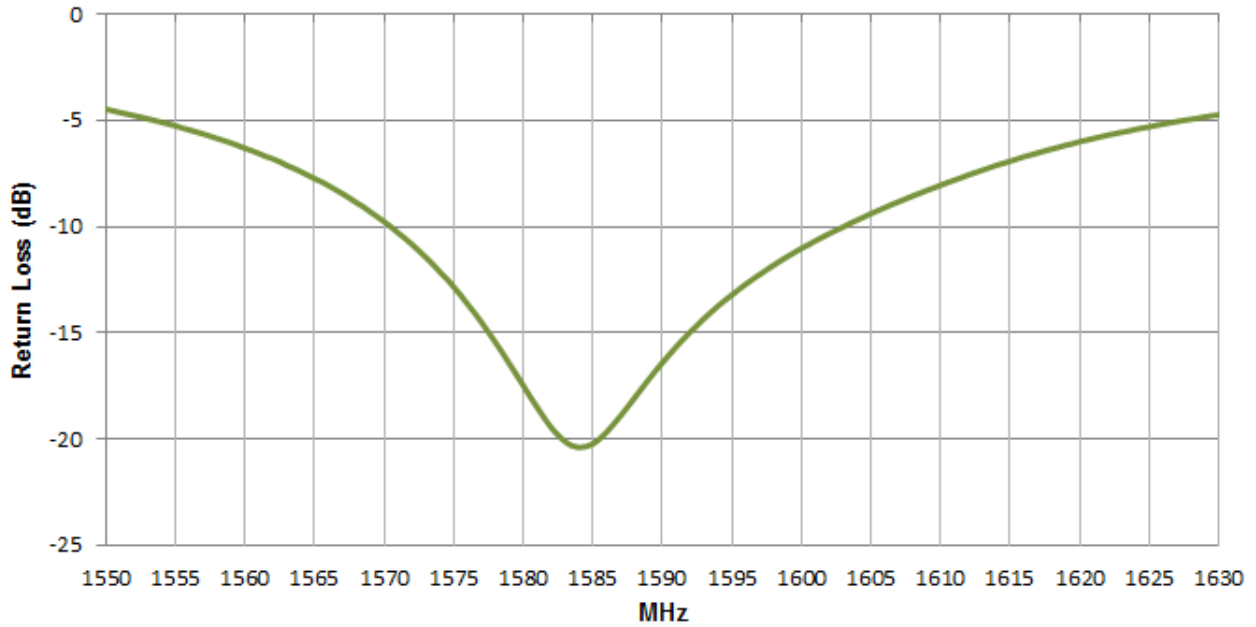

4.2 VSWR

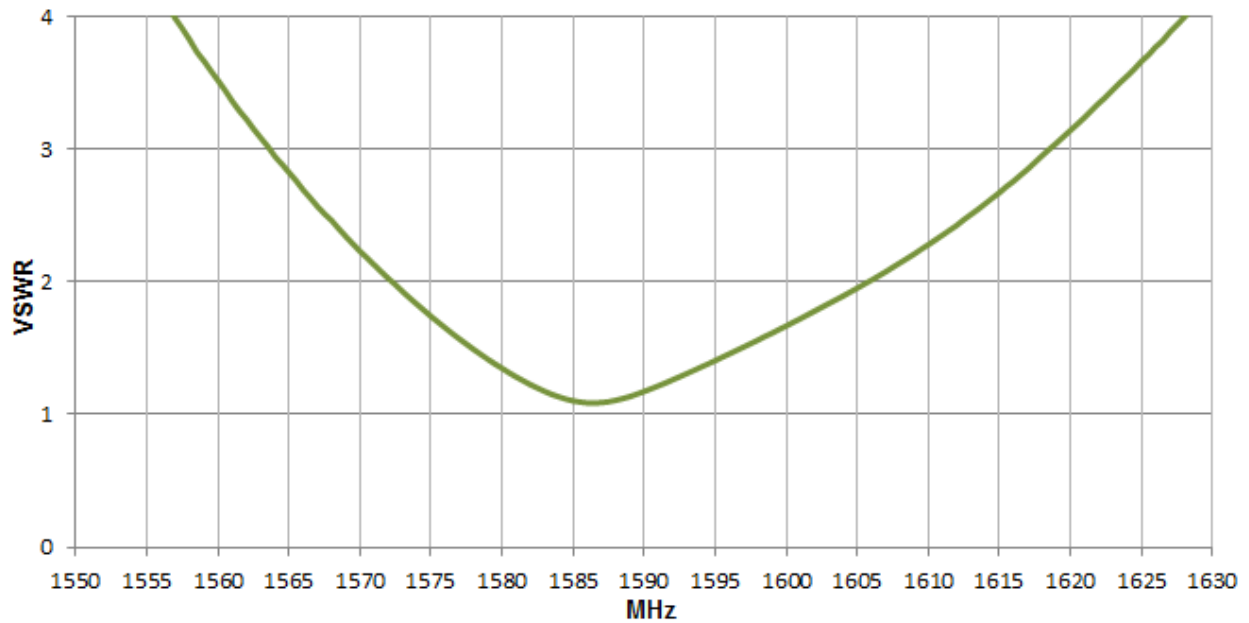

4.3 Efficiency

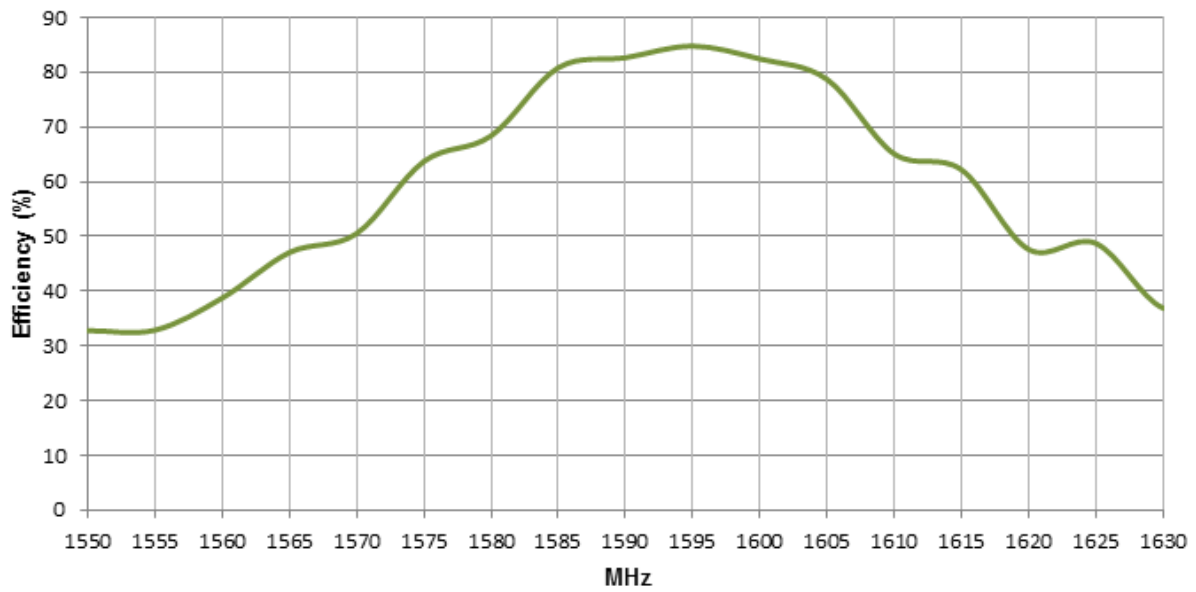

4.4 Peak Gain

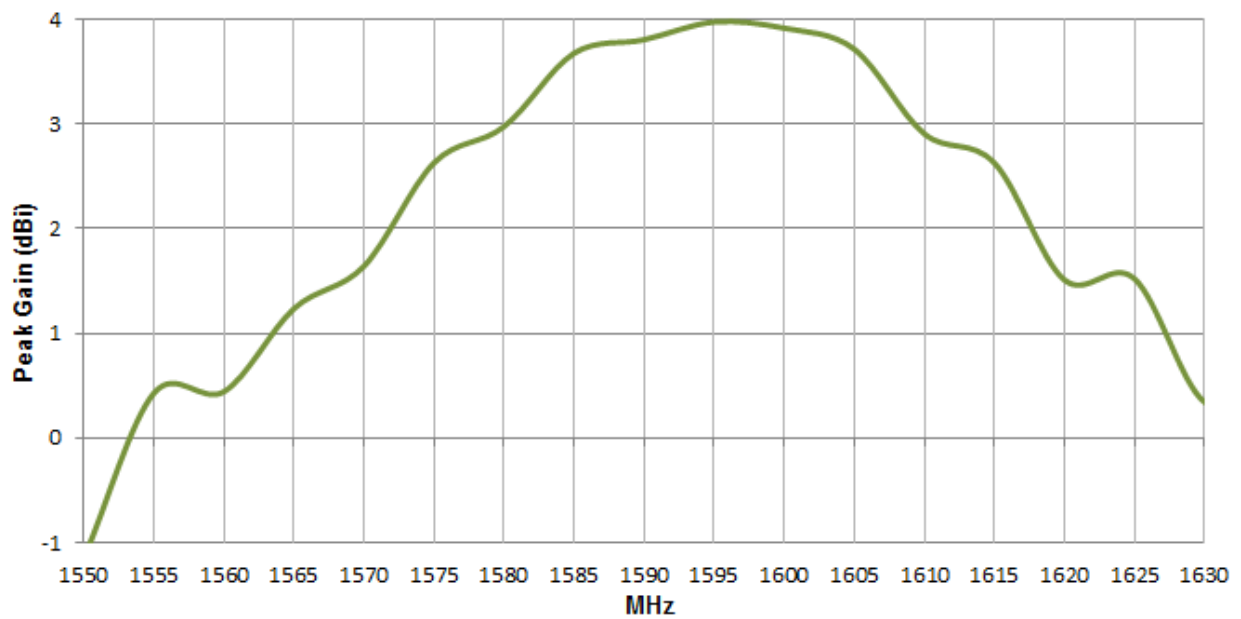

4. Antenna Radiation Pattern

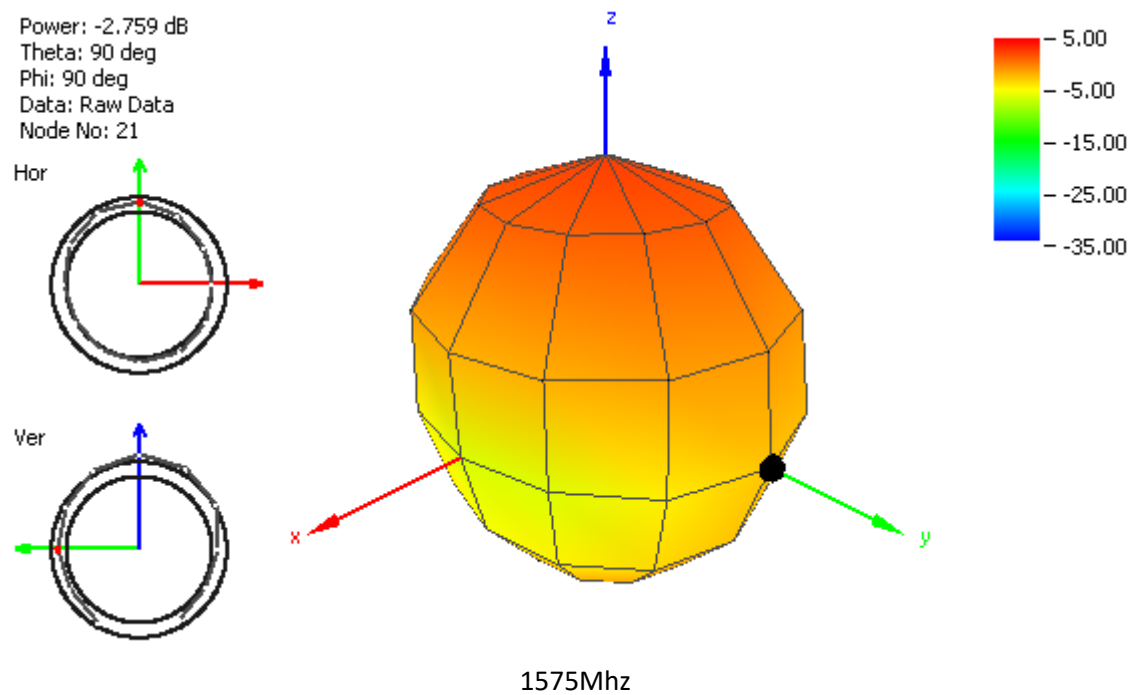
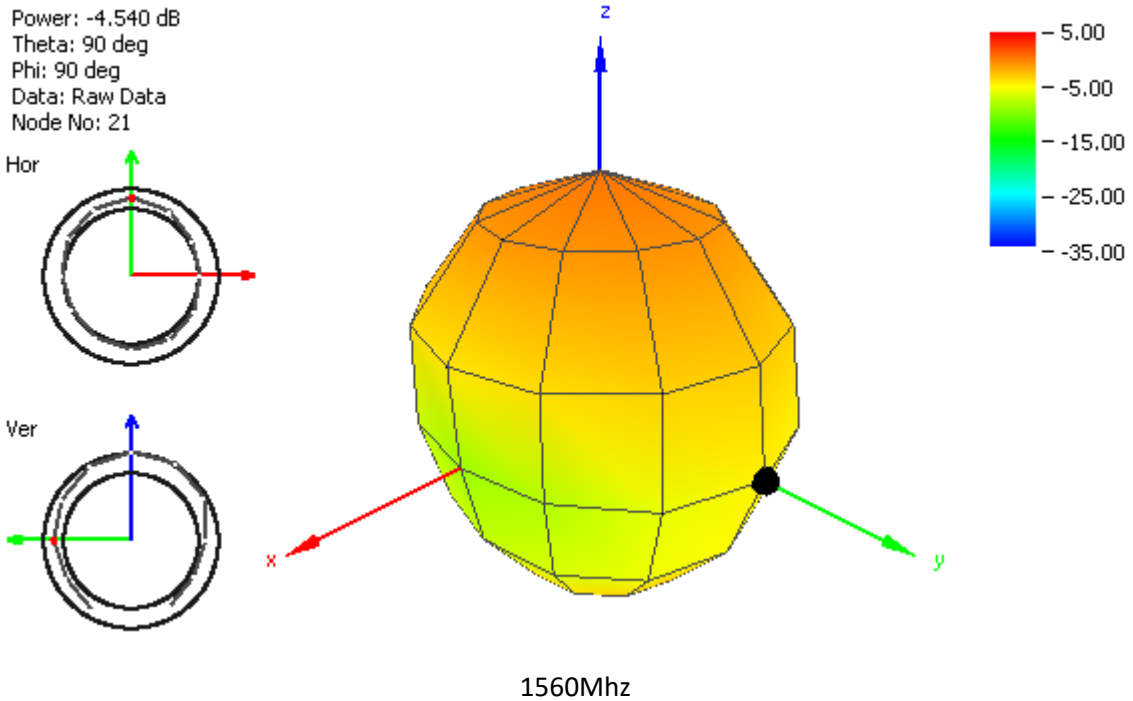

Power: -2.874 dB
 Theta: 90 deg
 Phi: 90 deg
 Data: Raw Data
 Node No: 21

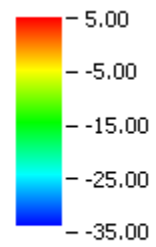
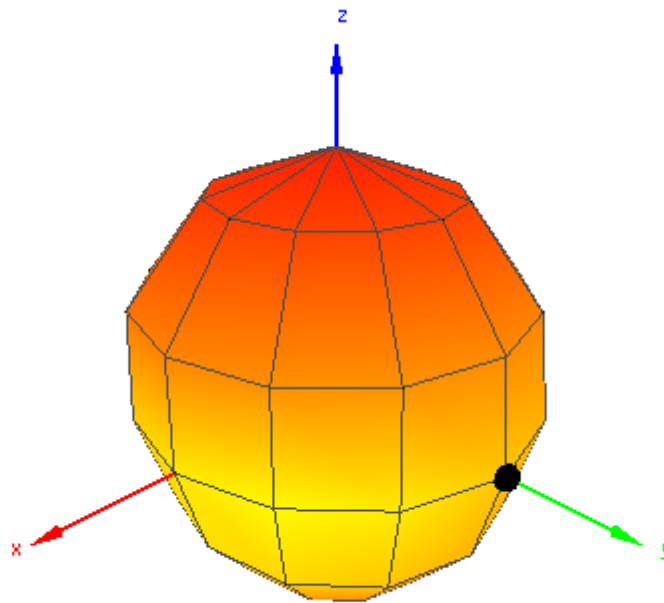
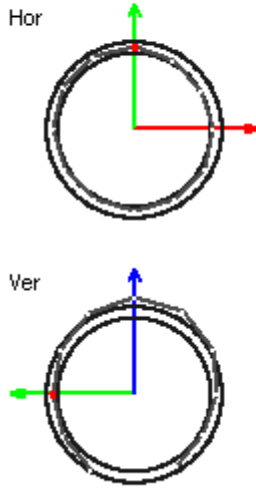

1590Mhz

Power: -4.260 dB
 Theta: 90 deg
 Phi: 90 deg
 Data: Raw Data
 Node No: 21

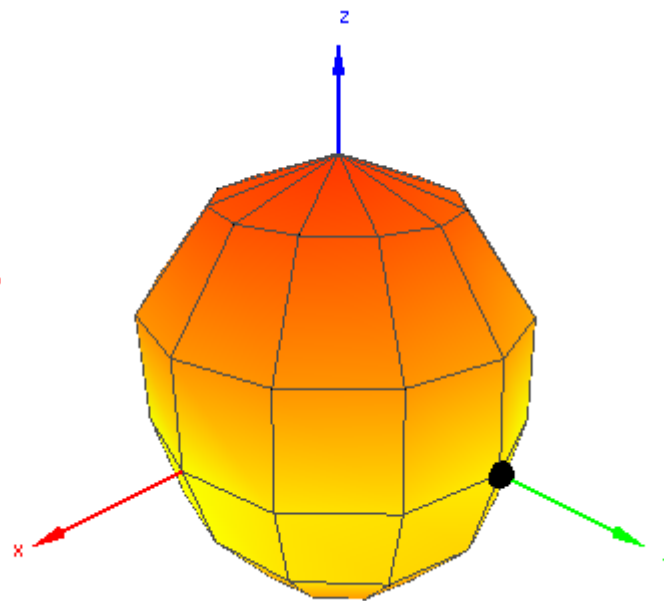
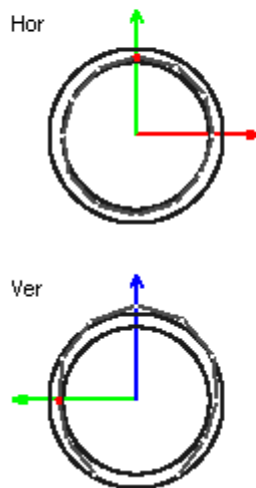

1610Mhz

5. Axial Ratio

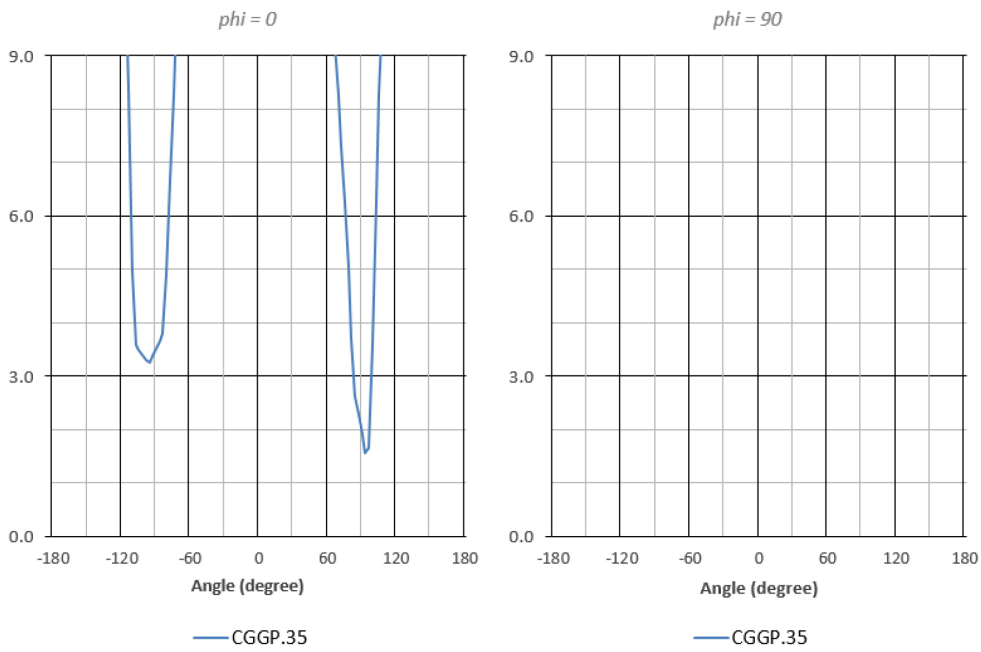

1575.42MHz

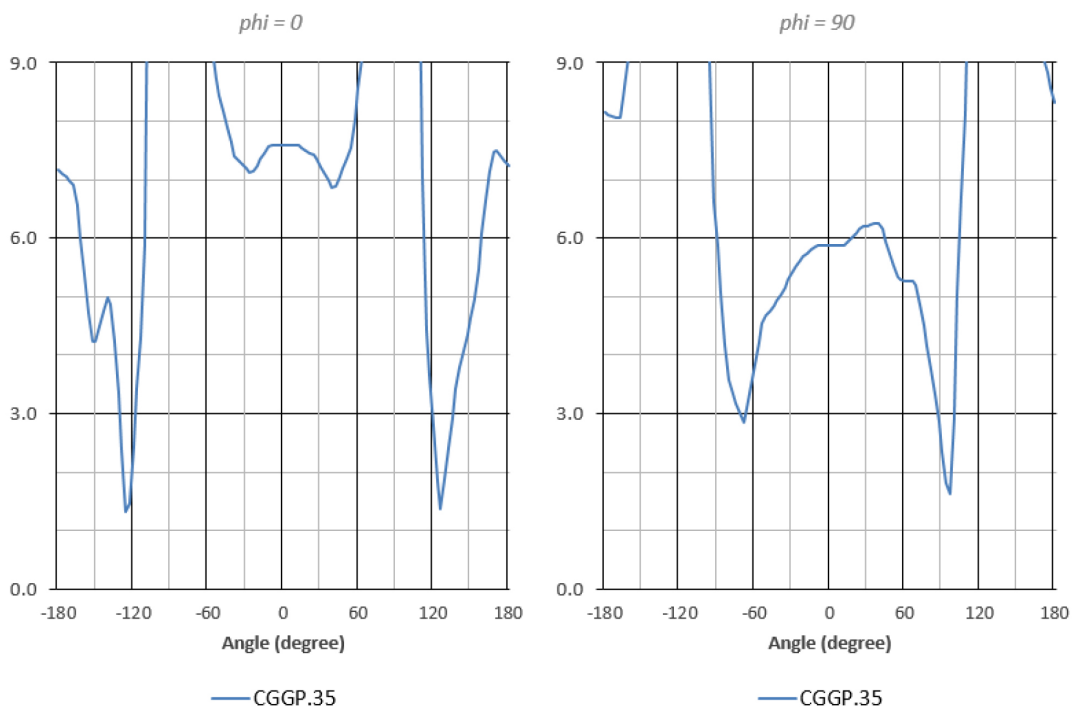

1602MHz

6. Mechanical Drawing (Unit: mm)

ISO NO.: EDW-11-8-387

STATE: Release

NOTES: 1. Double sided adhesive area

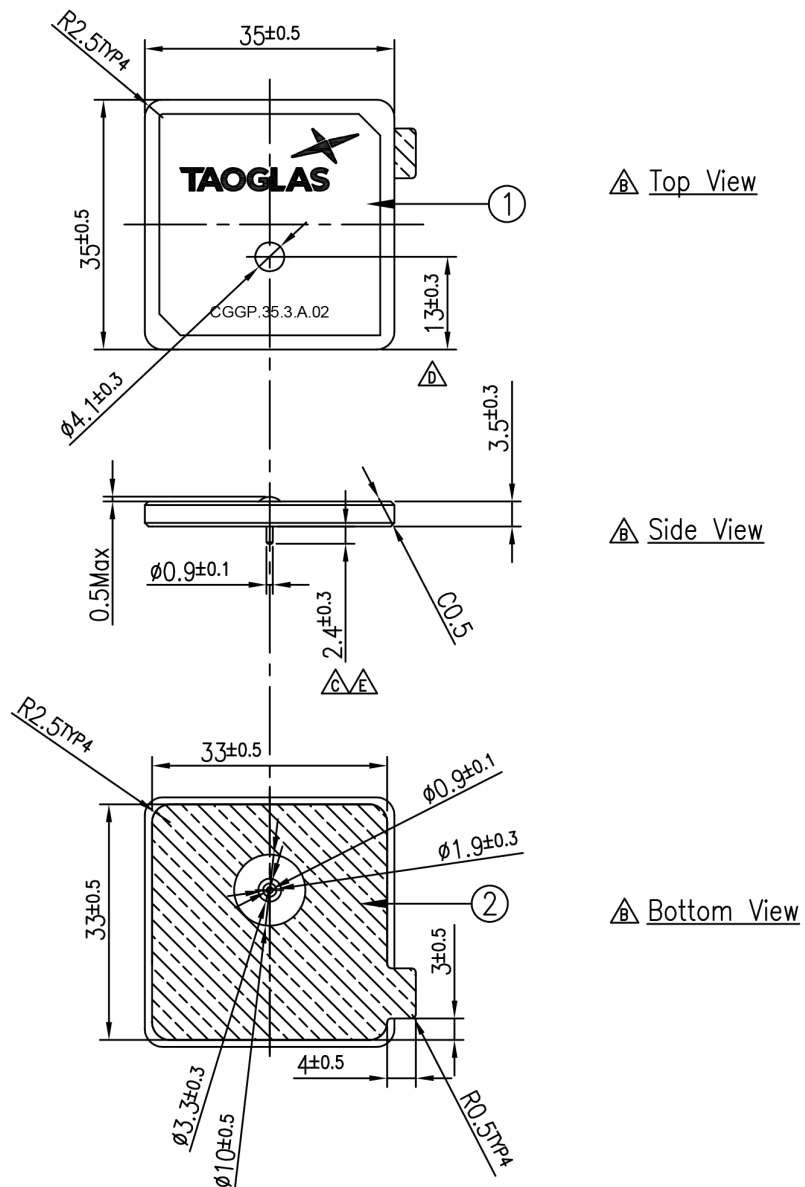

| | Name | P/N | Material | Finish | QTY |
|---|-------------------------|----------------|------------|-------------|-----|
| 1 | CGGP.35 Patch 35x35x3.5 | 001513C080007A | Ceramic | Clear | 1 |
| 2 | Double sided Adhesive | 001013C020007A | NITTO 5015 | White Liner | 1 |

Adhesive Thickness

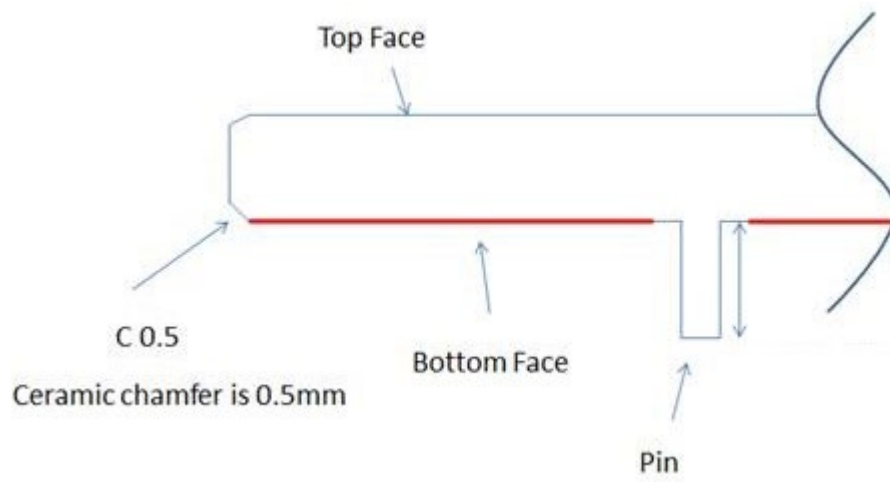

Red Line shows the adhesive without Liner – thickness 0.08~0.1mm

7. PCB Footprint Recommendation

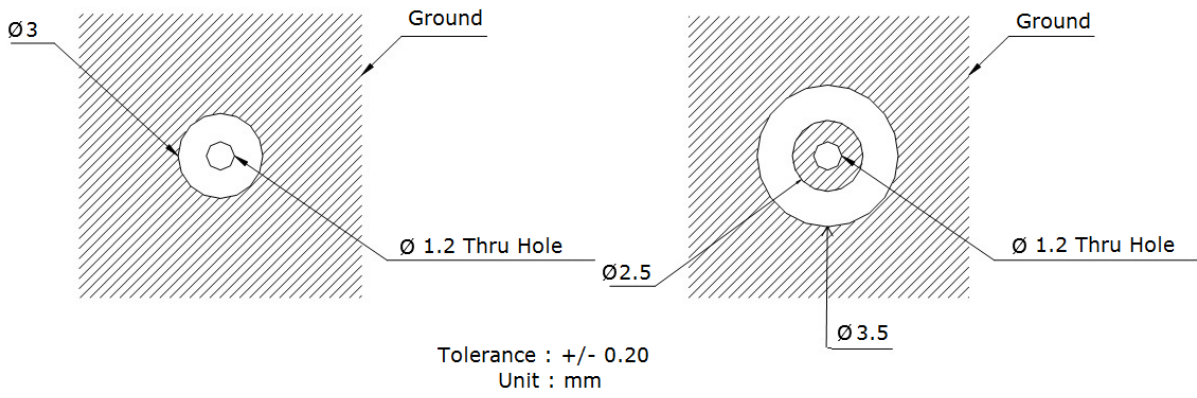

8. Antenna Integration Guide

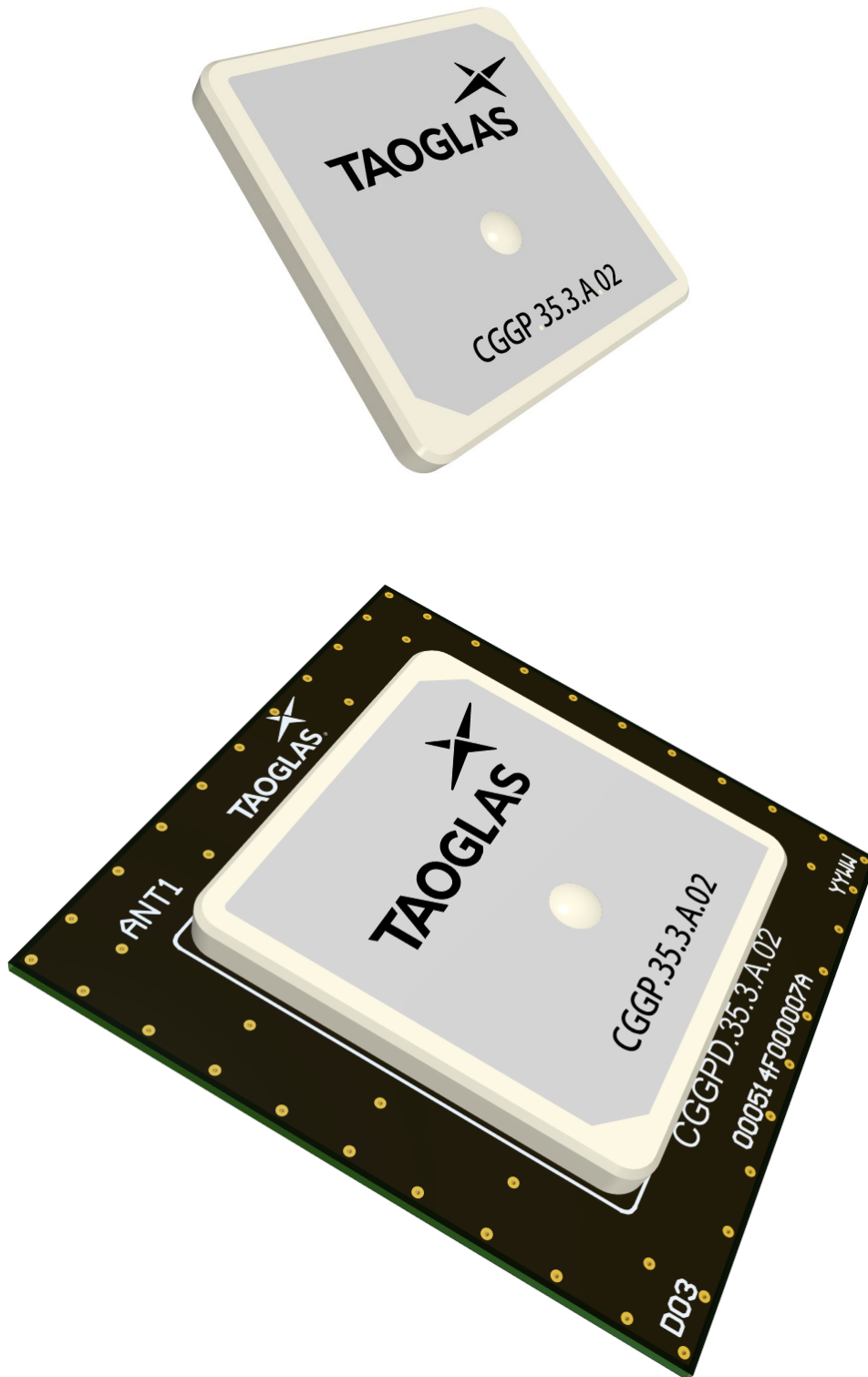

8.1 Schematic Symbol and Pin Definition

The circuit symbol for the antenna is shown below. The antenna has 1 pin as indicated below.

| Pin | Description |
|-----|-------------|
| 1 | RF Feed |



8.2 Antenna Integration

The antenna should be placed at the center of the ground plane with a length and width of 50mm. Maintaining a square symmetric ground plane shape and symmetric environment around the antenna is critical to maintaining the excellent axial ratio and phase center performance shown in this datasheet.



Top Side w/ Solder Mask



Top Side w/o Solder Mask

8.3 PCB Layout

The footprint and clearance on the PCB must comply with the antenna specification. The PCB layout shown in the diagram below demonstrates the antenna footprint.

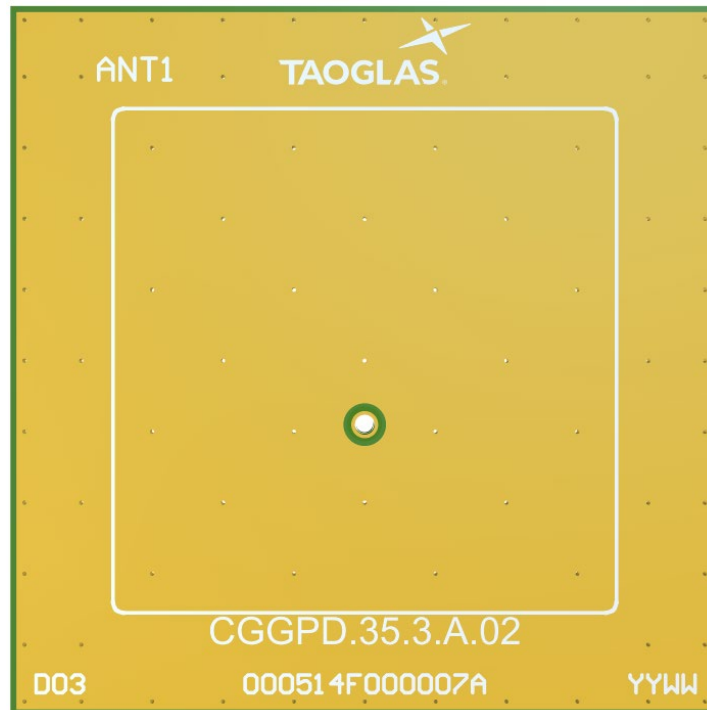

Topside

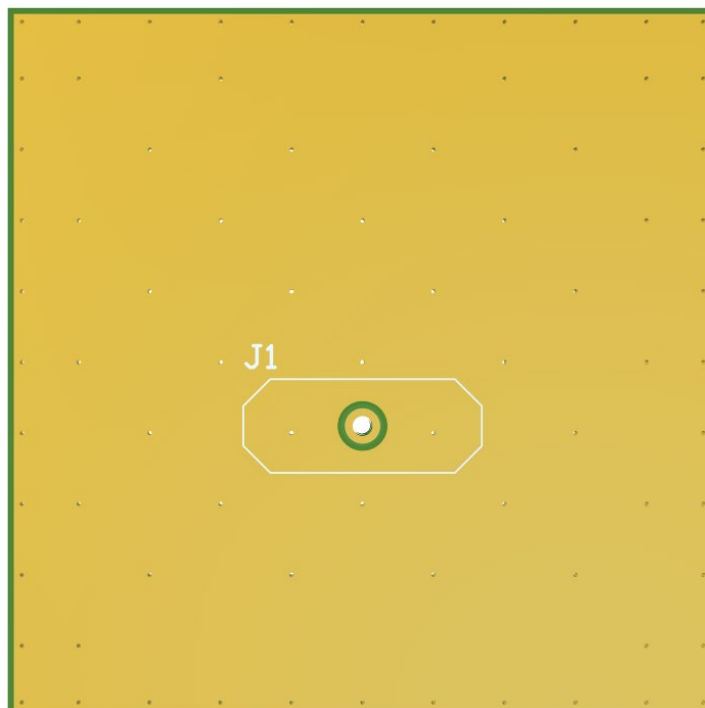

Bottom Side

8.4 Evaluation Board

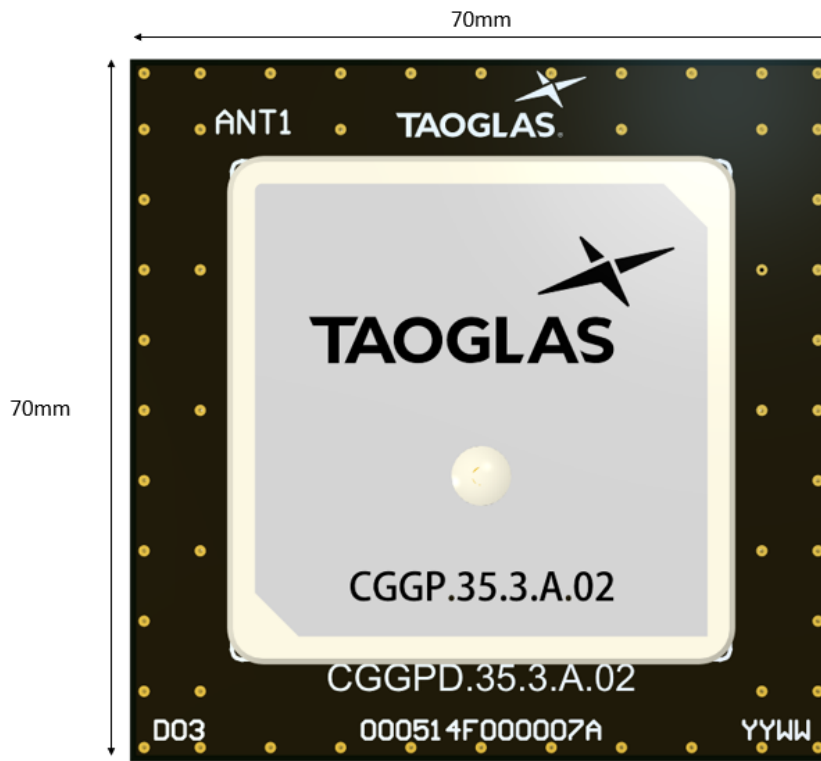

Topside

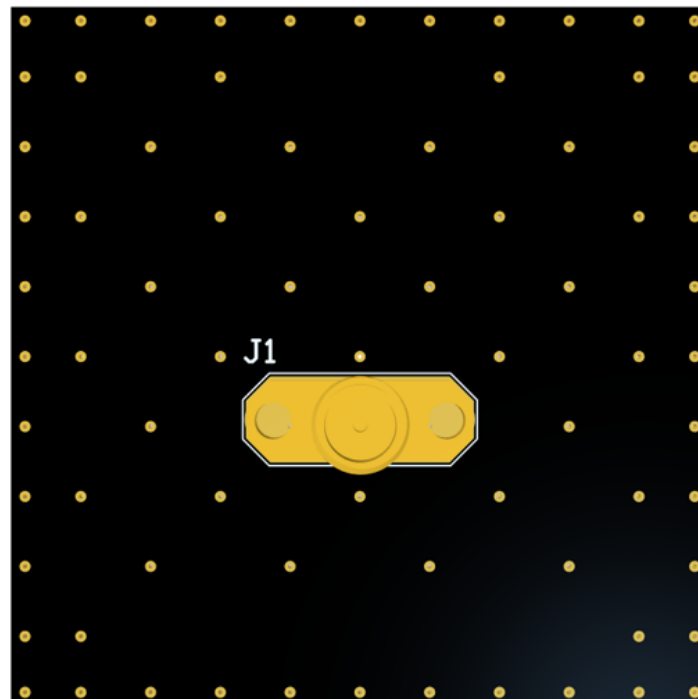

Bottom Side

9. Evaluation Board Mechanical Drawing (Unit: mm)

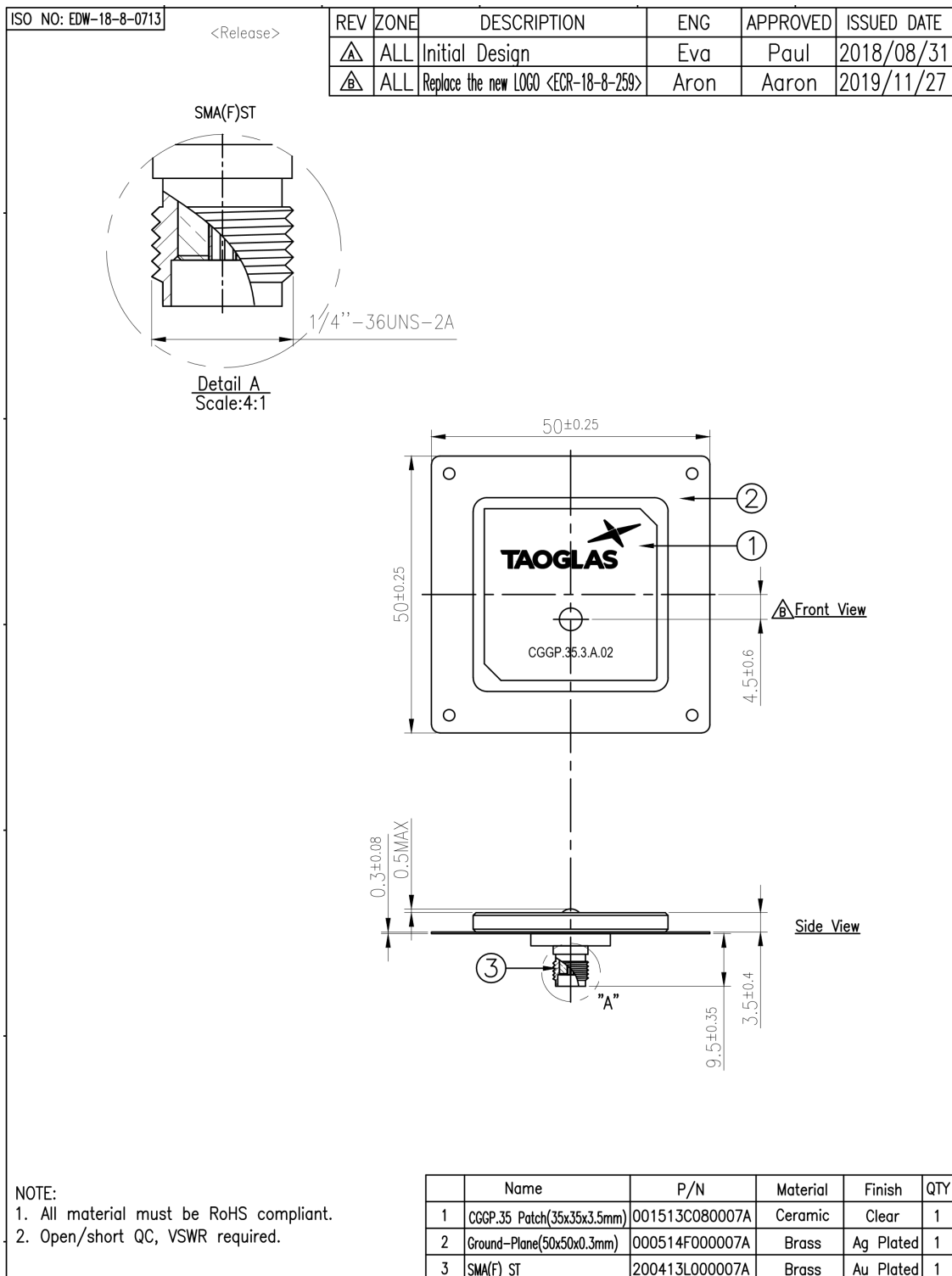

10. Packaging

CGGP.35.3.A.02

Packaging Specifications

12 Pieces CGGP.35 per tray
 Dimensions - Diameter 250*150*20mm
 Weight - 220g

6 Trays per Small Carton
 72 Pieces CGGP.35 Carton
 Dimensions - 260*160*120
 Weight - 1.37Kg

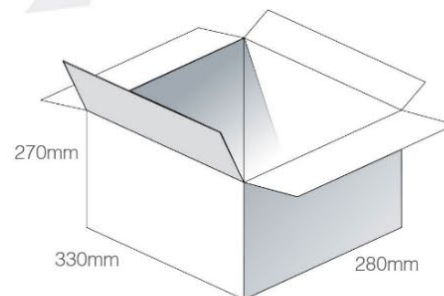
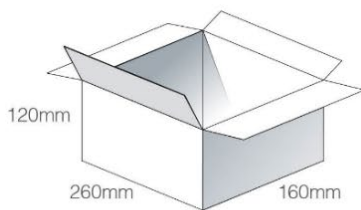
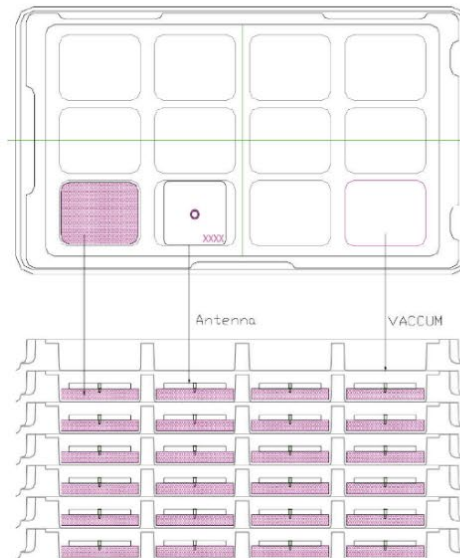

4 Small Cartons per 1 Large Carton
 288 Pieces CGGP.35 per Large Carton
 Carton Dimensions - 330*280*270
 Weight - 6Kg

Pallet Dimensions 1100*1100*1550mm
 60 Cartons per Pallet
 12 Cartons per layer
 5 Layers

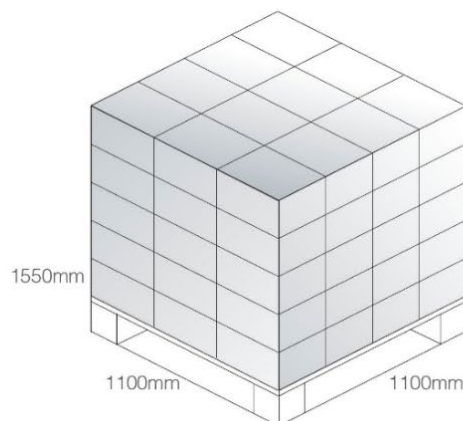

Changelog for the datasheet

SPE-11-8-062- CGGP.35.3.A.02

Revision: P (Current Version)

| | |
|------------------|---|
| Date: | 2024-05-24 |
| Changes: | Removed moisture sensitivity level information from datasheet |
| Changes Made by: | Conor McGrath |

Previous Revisions

Revision: O

| | |
|------------------|---------------------------------|
| Date: | 2023-02-27 |
| Changes: | Antenna Integration Guide Added |
| Changes Made by: | Cesar Sousa |

Revision: J

| | |
|------------------|----------------------------|
| Date: | 2016-09-09 |
| Changes: | Updated drawing as per PCN |
| Changes Made by: | Andy Mahoney |

Revision: N

| | |
|------------------|--|
| Date: | 2021-06-12 |
| Changes: | Updated Pin Length to 2.4mm Updated Drawing |
| Changes Made by: | Dan Cantwell |

Revision: I

| | |
|------------------|------------------------|
| Date: | 2016-05-12 |
| Changes: | Updated Packaging Spec |
| Changes Made by: | Aine Doyle |

Revision: M

| | |
|------------------|-----------------------|
| Date: | 2020-11-23 |
| Changes: | Updated to new format |
| Changes Made by: | Dan Cantwell |

Revision: H

| | |
|------------------|---------------------------------------|
| Date: | 2015-10-02 |
| Changes: | Added efficiency Rating to cover page |
| Changes Made by: | Aine Doyle |

Revision: L

| | |
|------------------|-----------------|
| Date: | 2019-04-12 |
| Changes: | Added AR Values |
| Changes Made by: | David Connolly |

Revision: G

| | |
|------------------|-----------------------|
| Date: | 2015-06-01 |
| Changes: | Amended PCB Footprint |
| Changes Made by: | Aine Doyle |

Revision: K

| | |
|------------------|------------------|
| Date: | 2019-02-12 |
| Changes: | Amended Drawing |
| Changes Made by: | Technical Writer |

Revision: F

| | |
|------------------|--|
| Date: | 2014-08-19 |
| Changes: | Removed Circular Polarization data from spec |
| Changes Made by: | Aine Doyle |

| | |
|--------------------|----------------------|
| Revision: E | |
| Date: | 2014-07-04 |
| Changes: | Updated test results |
| Changes Made by: | Aine Doyle |

| | |
|--------------------|-----------------------|
| Revision: D | |
| Date: | 2014-11-06 |
| Changes: | Added EBV information |
| Changes Made by: | Aine Doyle |

| | |
|--------------------|---|
| Revision: C | |
| Date: | 2013-04-15 |
| Changes: | updated Supplier spec with GND plane info |
| Changes Made by: | Aine Doyle |

| | |
|--------------------|------------------|
| Revision: B | |
| Date: | 2011-08-30 |
| Changes: | |
| Changes Made by: | Technical Writer |

| | |
|---|------------------|
| Revision: A (Original First Release) | |
| Date: | 2011-07-29 |
| Notes: | |
| Author: | Technical Writer |



TAOGLAS®

www.taoglas.com



Mouser Electronics

Authorized Distributor

Click to View Pricing, Inventory, Delivery & Lifecycle Information:

[Taoglas:](#)

[CGGP.35.3.A.02](#)