

Notice for TAIYO YUDEN products

Please read this notice before using the TAIYO YUDEN products.

⚠️ REMINDERS

■ Product Information in this Catalog

Product information in this catalog is as of January 2021. All of the contents specified herein and production status of the products listed in this catalog are subject to change without notice due to technical improvement of our products, etc. Therefore, please check for the latest information carefully before practical application or use of our products.

Please note that TAIYO YUDEN shall not be in any way responsible for any damages and defects in products or equipment incorporating our products, which are caused under the conditions other than those specified in this catalog or individual product specification sheets.

■ Approval of Product Specifications

Please contact TAIYO YUDEN for further details of product specifications as the individual product specification sheets are available. When using our products, please be sure to approve our product specifications or make a written agreement on the product specification with TAIYO YUDEN in advance.

■ Pre-Evaluation in the Actual Equipment and Conditions

Please conduct validation and verification of our products in actual conditions of mounting and operating environment before using our products.

■ Limited Application

1. Equipment Intended for Use

The products listed in this catalog are intended for general-purpose and standard use in general electronic equipment (e.g., AV equipment, OA equipment, home electric appliances, office equipment, information and communication equipment including, without limitation, mobile phone, and PC) and other equipment specified in this catalog or the individual product specification sheets.

TAIYO YUDEN has the line-up of the products intended for use in automotive electronic equipment, telecommunications infrastructure and industrial equipment, or medical devices classified as GHTF Classes A to C (Japan Classes I to III). Therefore, when using our products for these equipment, please check available applications specified in this catalog or the individual product specification sheets and use the corresponding products.

2. Equipment Requiring Inquiry

Please be sure to contact TAIYO YUDEN for further information before using the products listed in this catalog for the following equipment (excluding intended equipment as specified in this catalog or the individual product specification sheets) which may cause loss of human life, bodily injury, serious property damage and/or serious public impact due to a failure or defect of the products and/or malfunction attributed thereto.

- (1) Transportation equipment (automotive powertrain control system, train control system, and ship control system, etc.)
- (2) Traffic signal equipment
- (3) Disaster prevention equipment, crime prevention equipment
- (4) Medical devices classified as GHTF Class C (Japan Class III)
- (5) Highly public information network equipment, data-processing equipment (telephone exchange, and base station, etc.)
- (6) Any other equipment requiring high levels of quality and/or reliability equal to the equipment listed above

3. Equipment Prohibited for Use

Please do not incorporate our products into the following equipment requiring extremely high levels of safety and/or reliability.

- (1) Aerospace equipment (artificial satellite, rocket, etc.)
- (2) Aviation equipment *¹
- (3) Medical devices classified as GHTF Class D (Japan Class IV), implantable medical devices *²

- (4) Power generation control equipment (nuclear power, hydroelectric power, thermal power plant control system, etc.)
- (5) Undersea equipment (submarine repeating equipment, underwater work equipment, etc.)
- (6) Military equipment
- (7) Any other equipment requiring extremely high levels of safety and/or reliability equal to the equipment listed above

*Notes:

1. There is a possibility that our products can be used only for aviation equipment that does not directly affect the safe operation of aircraft (e.g., in-flight entertainment, cabin light, electric seat, cooking equipment) if such use meets requirements specified separately by TAIYO YUDEN. Please be sure to contact TAIYO YUDEN for further information before using our products for such aviation equipment.
2. Implantable medical devices contain not only internal unit which is implanted in a body, but also external unit which is connected to the internal unit.

4. Limitation of Liability

Please note that unless you obtain prior written consent of TAIYO YUDEN, TAIYO YUDEN shall not be in any way responsible for any damages incurred by you or third parties arising from use of the products listed in this catalog for any equipment that is not intended for use by TAIYO YUDEN, or any equipment requiring inquiry to TAIYO YUDEN or prohibited for use by TAIYO YUDEN as described above.

■ Safety Design

When using our products for high safety and/or reliability-required equipment or circuits, please fully perform safety and/or reliability evaluation. In addition, please install (i) systems equipped with a protection circuit and a protection device and/or (ii) systems equipped with a redundant circuit or other system to prevent an unsafe status in the event of a single fault for a failsafe design to ensure safety.

■ Intellectual Property Rights

Information contained in this catalog is intended to convey examples of typical performances and/or applications of our products and is not intended to make any warranty with respect to the intellectual property rights or any other related rights of TAIYO YUDEN or any third parties nor grant any license under such rights.

■ Limited Warranty

Please note that the scope of warranty for our products is limited to the delivered our products themselves and TAIYO YUDEN shall not be in any way responsible for any damages resulting from a failure or defect in our products. Notwithstanding the foregoing, if there is a written agreement (e.g., supply and purchase agreement, quality assurance agreement) signed by TAIYO YUDEN and your company, TAIYO YUDEN will warrant our products in accordance with such agreement.

■ TAIYO YUDEN's Official Sales Channel

The contents of this catalog are applicable to our products which are purchased from our sales offices or authorized distributors (hereinafter "TAIYO YUDEN's official sales channel"). Please note that the contents of this catalog are not applicable to our products purchased from any seller other than TAIYO YUDEN's official sales channel.

■ Caution for Export

Some of our products listed in this catalog may require specific procedures for export according to "U.S. Export Administration Regulations", "Foreign Exchange and Foreign Trade Control Law" of Japan, and other applicable regulations. Should you have any questions on this matter, please contact our sales staff.

▶ This catalog contains the typical specification only due to the limitation of space. When you consider the purchase of our products, please check our product specification sheets. For details of each product (characteristics graph, reliability information, precautions for use, and so on), see our website (<http://www.ty-top.com/>).

WIRE-WOUND CHIP INDUCTORS (LB SERIES)

REFLOW

■ PARTS NUMBER

* Operating Temp.: -40~+105°C (Including self-generated heat)

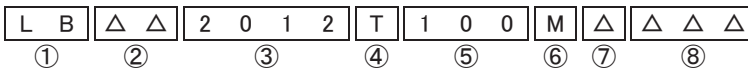

Δ = Blank space

① Series name

Code	Series name
LB	Wound chip inductor

④ Packaging

Code	Packaging
T	Taping

② Characteristics

Code	Characteristics
△△	Standard
△C	High current
△R	Low Rdc
MF	Low loss

⑤ Nominal inductance

Code (example)	Nominal inductance [μH]
1R0	1.0
100	10
101	100

※R=Decimal point

③ Dimensions (L × W)

Code	Type (inch)	Dimensions (L × W) [mm]
1608	1608(0603)	1.6 × 0.8
2012	2012(0805)	2.0 × 1.25
2016	2016(0806)	2.0 × 1.6
2518	2518(1007)	2.5 × 1.8
3218	3218(1207)	3.2 × 1.8
3225	3225(1210)	3.2 × 2.5

⑥ Inductance tolerance

Code	Inductance tolerance
K	±10%
M	±20%

⑦ Special code

Code	Special code
△	Standard
R	Low Rdc type

⑧ Internal code

■ STANDARD EXTERNAL DIMENSIONS / STANDARD QUANTITY

LB/LB C/LB R

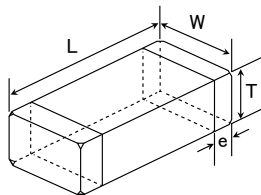

LBMF

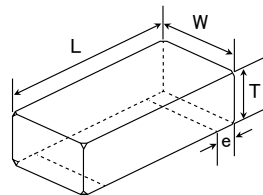

Recommended Land Patterns

Surface Mounting

- Mounting and soldering conditions should be checked beforehand.
- Applicable soldering process to these products is reflow soldering only.

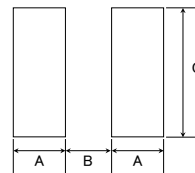

Type	A	B	C
1608	0.55	0.7	0.9
MF1608	0.55	0.7	1.0
2012	0.60	1.0	1.45
2016	0.60	1.0	1.8
2518	0.60	1.5	2.0
3218	0.85	1.7	2.0
3225	0.85	1.7	2.7

Unit: mm

Type	L	W	T	e	Standard quantity [pcs]	
					Paper tape	Embossed tape
LB 1608	1.6 ± 0.1 (0.063 ± 0.004)	0.8 ± 0.1 (0.031 ± 0.004)	0.8 ± 0.1 (0.031 ± 0.004)	0.35 ± 0.15 (0.014 ± 0.006)	4000	—
LBMF1608	1.6 ± 0.2 (0.063 ± 0.008)	0.8 ± 0.2 (0.031 ± 0.008)	0.8 ± 0.2 (0.031 ± 0.008)	0.45 ± 0.15 (0.016 ± 0.006)	—	3000
LB 2012 LB C2012 LB R2012	2.0 ± 0.2 (0.079 ± 0.008)	1.25 ± 0.2 (0.049 ± 0.008)	1.25 ± 0.2 (0.049 ± 0.008)	0.5 ± 0.2 (0.020 ± 0.008)	—	3000
LB 2016 LB C2016	2.0 ± 0.2 (0.079 ± 0.008)	1.6 ± 0.2 (0.063 ± 0.008)	1.6 ± 0.2 (0.063 ± 0.008)	0.5 ± 0.2 (0.020 ± 0.008)	—	2000
LB 2518 LB C2518 LB R2518	2.5 ± 0.2 (0.098 ± 0.008)	1.8 ± 0.2 (0.071 ± 0.008)	1.8 ± 0.2 (0.071 ± 0.008)	0.5 ± 0.2 (0.020 ± 0.008)	—	2000
LB 3218	3.2 ± 0.2 (0.126 ± 0.008)	1.8 ± 0.2 (0.071 ± 0.008)	1.8 ± 0.2 (0.071 ± 0.008)	0.6 ± 0.2 (0.024 ± 0.008)	—	2000
LB C3225	3.2 ± 0.2 (0.126 ± 0.008)	2.5 ± 0.2 (0.098 ± 0.008)	2.5 ± 0.2 (0.098 ± 0.008)	0.6 ± 0.3 (0.024 ± 0.012)	—	1000

Unit: mm (inch)

▶ This catalog contains the typical specification only due to the limitation of space. When you consider the purchase of our products, please check our product specification sheets. For details of each product (characteristics graph, reliability information, precautions for use, and so on), see our website (<http://www.ty-top.com/>).

PARTS NUMBER

1608 (0603) type

Parts number	EHS	Nominal inductance [μ H]	Inductance tolerance	Self-resonant frequency [MHz] (min.)	DC Resistance [Ω] ($\pm 30\%$)	Rated current [mA] (max.)	Measuring frequency [MHz]
LB 1608T1R0M	RoHS	1.0	$\pm 20\%$	100	0.17	160	7.96
LB 1608T2R2M	RoHS	2.2	$\pm 20\%$	80	0.33	115	7.96
LB 1608T4R7M	RoHS	4.7	$\pm 20\%$	45	0.55	70	7.96
LB 1608T8R2M	RoHS	8.2	$\pm 20\%$	32	0.70	60	2.52
LB 1608T100M	RoHS	10	$\pm 20\%$	32	0.70	60	2.52

Parts number	EHS	Nominal inductance [μ H]	Inductance tolerance	Self-resonant frequency [MHz] (min.)	DC Resistance [Ω] ($\pm 30\%$)	Rated current [mA] (max.)	Measuring frequency [MHz]
LBMF1608T1R0M	RoHS	1.0	$\pm 20\%$	100	0.09	230	7.96
LBMF1608T2R2M	RoHS	2.2	$\pm 20\%$	80	0.17	160	7.96
LBMF1608T3R3M	RoHS	3.3	$\pm 20\%$	60	0.22	130	7.96
LBMF1608T4R7M	RoHS	4.7	$\pm 20\%$	45	0.24	110	7.96
LBMF1608T100□	RoHS	10	$\pm 10\%$, $\pm 20\%$	32	0.36	80	2.52
LBMF1608T220□	RoHS	22	$\pm 10\%$, $\pm 20\%$	16	1.0	50	2.52
LBMF1608T470□	RoHS	47	$\pm 10\%$, $\pm 20\%$	11	2.5	35	2.52

2012 (0805) type

Parts number	EHS	Nominal inductance [μ H]	Inductance tolerance	Self-resonant frequency [MHz] (min.)	DC Resistance [Ω] ($\pm 30\%$)	Rated current [mA] (max.)	Measuring frequency [MHz]
LB 2012T1R0M	RoHS	1.0	$\pm 20\%$	100	0.15	405	7.96
LB 2012T2R2M	RoHS	2.2	$\pm 20\%$	80	0.23	260	7.96
LB 2012T3R3M	RoHS	3.3	$\pm 20\%$	55	0.30	235	7.96
LB 2012T4R7M	RoHS	4.7	$\pm 20\%$	45	0.40	190	7.96
LB 2012T6R8M	RoHS	6.8	$\pm 20\%$	38	0.47	135	7.96
LB 2012T100□	RoHS	10	$\pm 10\%$, $\pm 20\%$	32	0.70	120	2.52
LB 2012T100□R	RoHS	10	$\pm 10\%$, $\pm 20\%$	32	0.50	120	2.52
LB 2012T150□	RoHS	15	$\pm 10\%$, $\pm 20\%$	28	1.3	100	2.52
LB 2012T220□	RoHS	22	$\pm 10\%$, $\pm 20\%$	16	1.7	80	2.52
LB 2012T470□	RoHS	47	$\pm 10\%$, $\pm 20\%$	11	3.7	60	2.52
LB 2012T680□	RoHS	68	$\pm 10\%$, $\pm 20\%$	10	6.0	50	2.52
LB 2012T101□	RoHS	100	$\pm 10\%$, $\pm 20\%$	8	7.0	45	0.796

Parts number	EHS	Nominal inductance [μ H]	Inductance tolerance	Self-resonant frequency [MHz] (min.)	DC Resistance [Ω] ($\pm 30\%$)	Rated current [mA] (max.)	Measuring frequency [MHz]
LB C2012T1R0M	RoHS	1.0	$\pm 20\%$	100	0.19	620	7.96
LB C2012T2R2M	RoHS	2.2	$\pm 20\%$	70	0.33	430	7.96
LB C2012T4R7M	RoHS	4.7	$\pm 20\%$	45	0.50	295	7.96
LB C2012T100□	RoHS	10	$\pm 10\%$, $\pm 20\%$	40	1.2	200	2.52
LB C2012T220□	RoHS	22	$\pm 10\%$, $\pm 20\%$	16	3.7	130	2.52
LB C2012T470□	RoHS	47	$\pm 10\%$, $\pm 20\%$	11	5.8	90	2.52

Parts number	EHS	Nominal inductance [μ H]	Inductance tolerance	Self-resonant frequency [MHz] (min.)	DC Resistance [Ω] ($\pm 30\%$)	Rated current [mA] (max.)	Measuring frequency [MHz]
LB R2012T1R0M	RoHS	1.0	$\pm 20\%$	100	0.07	400	7.96
LB R2012T2R2M	RoHS	2.2	$\pm 20\%$	80	0.13	260	7.96
LB R2012T4R7M	RoHS	4.7	$\pm 20\%$	45	0.24	200	7.96
LB R2012T100□	RoHS	10	$\pm 10\%$, $\pm 20\%$	32	0.36	150	2.52
LB R2012T220□	RoHS	22	$\pm 10\%$, $\pm 20\%$	16	1.0	100	2.52
LB R2012T470□	RoHS	47	$\pm 10\%$, $\pm 20\%$	11	1.7	75	2.52
LB R2012T101□	RoHS	100	$\pm 10\%$, $\pm 20\%$	8	4.0	50	0.796

2016 (0806) type

Parts number	EHS	Nominal inductance [μ H]	Inductance tolerance	Self-resonant frequency [MHz] (min.)	DC Resistance [Ω] ($\pm 30\%$)	Rated current [mA] (max.)	Measuring frequency [MHz]
LB 2016T1R0M	RoHS	1.0	$\pm 20\%$	100	0.09	490	7.96
LB 2016T1R5M	RoHS	1.5	$\pm 20\%$	80	0.11	380	7.96
LB 2016T2R2M	RoHS	2.2	$\pm 20\%$	70	0.13	375	7.96
LB 2016T3R3M	RoHS	3.3	$\pm 20\%$	55	0.20	285	7.96
LB 2016T4R7M	RoHS	4.7	$\pm 20\%$	45	0.25	225	7.96
LB 2016T6R8M	RoHS	6.8	$\pm 20\%$	38	0.35	200	7.96
LB 2016T100□	RoHS	10	$\pm 10\%$, $\pm 20\%$	32	0.50	155	2.52
LB 2016T150□	RoHS	15	$\pm 10\%$, $\pm 20\%$	28	0.70	130	2.52
LB 2016T220□	RoHS	22	$\pm 10\%$, $\pm 20\%$	16	1.0	105	2.52
LB 2016T330□	RoHS	33	$\pm 10\%$, $\pm 20\%$	14	1.7	85	2.52
LB 2016T470□	RoHS	47	$\pm 10\%$, $\pm 20\%$	11	2.4	70	2.52
LB 2016T680□	RoHS	68	$\pm 10\%$, $\pm 20\%$	10	3.0	55	2.52
LB 2016T101□	RoHS	100	$\pm 10\%$, $\pm 20\%$	8	4.5	40	0.796

□ Please specify the Inductance tolerance code (K or M)

LB/LBC series

Rated Current : The maximum DC value having inductance decrease within 10 % and temperature increase within 20 degC by the application of DC bias.

LBR series

Rated Current : The maximum DC value having inductance decrease within 20 % and temperature increase within 20 degC by the application of DC bias.

► This catalog contains the typical specification only due to the limitation of space. When you consider the purchase of our products, please check our product specification sheets. For details of each product (characteristics graph, reliability information, precautions for use, and so on), see our website (<http://www.ty-top.com/>).

PARTS NUMBER

Parts number	EHS	Nominal inductance [μ H]	Inductance tolerance	Self-resonant frequency [MHz] (min.)	DC Resistance [Ω] ($\pm 30\%$)	Rated current [mA] (max.)	Measuring frequency [MHz]
LB C2016T1R0M	RoHS	1.0	$\pm 20\%$	100	0.10	690	7.96
LB C2016T1R5M	RoHS	1.5	$\pm 20\%$	80	0.15	600	7.96
LB C2016T2R2M	RoHS	2.2	$\pm 20\%$	70	0.20	520	7.96
LB C2016T3R3M	RoHS	3.3	$\pm 20\%$	55	0.27	410	7.96
LB C2016T4R7M	RoHS	4.7	$\pm 20\%$	45	0.37	355	7.96
LB C2016T6R8M	RoHS	6.8	$\pm 20\%$	38	0.59	290	7.96
LB C2016T100□	RoHS	10	$\pm 10\%, \pm 20\%$	32	0.82	245	2.52
LB C2016T150□	RoHS	15	$\pm 10\%, \pm 20\%$	28	1.2	200	2.52
LB C2016T220□	RoHS	22	$\pm 10\%, \pm 20\%$	16	1.8	165	2.52
LB C2016T330□	RoHS	33	$\pm 10\%, \pm 20\%$	14	2.8	135	2.52
LB C2016T470□	RoHS	47	$\pm 10\%, \pm 20\%$	11	4.3	110	2.52
LB C2016T680□	RoHS	68	$\pm 10\%, \pm 20\%$	10	7.0	95	2.52
LB C2016T101□	RoHS	100	$\pm 10\%, \pm 20\%$	8	8.0	75	0.796

2518(1007)type

Parts number	EHS	Nominal inductance [μ H]	Inductance tolerance	Self-resonant frequency [MHz] (min.)	DC Resistance [Ω] ($\pm 30\%$)	Rated current [mA] (max.)	Measuring frequency [MHz]
LB 2518T1R0M	RoHS	1.0	$\pm 20\%$	100	0.06	665	7.96
LB 2518T1R5M	RoHS	1.5	$\pm 20\%$	80	0.07	405	7.96
LB 2518T2R2M	RoHS	2.2	$\pm 20\%$	68	0.09	340	7.96
LB 2518T3R3M	RoHS	3.3	$\pm 20\%$	54	0.11	280	7.96
LB 2518T4R7M	RoHS	4.7	$\pm 20\%$	46	0.13	240	7.96
LB 2518T4R7MR	RoHS	4.7	$\pm 20\%$	46	0.10	235	7.96
LB 2518T6R8M	RoHS	6.8	$\pm 20\%$	38	0.15	195	7.96
LB 2518T100□	RoHS	10	$\pm 10\%, \pm 20\%$	30	0.25	165	2.52
LB 2518T150□	RoHS	15	$\pm 10\%, \pm 20\%$	23	0.32	145	2.52
LB 2518T220□	RoHS	22	$\pm 10\%, \pm 20\%$	19	0.50	115	2.52
LB 2518T330□	RoHS	33	$\pm 10\%, \pm 20\%$	15	0.70	95	2.52
LB 2518T470□	RoHS	47	$\pm 10\%, \pm 20\%$	12	0.95	85	2.52
LB 2518T680□	RoHS	68	$\pm 10\%, \pm 20\%$	9.5	1.5	70	2.52
LB 2518T101□	RoHS	100	$\pm 10\%, \pm 20\%$	9.0	2.1	60	0.796
LB 2518T151□	RoHS	150	$\pm 10\%, \pm 20\%$	7.0	3.2	45	0.796
LB 2518T221□	RoHS	220	$\pm 10\%, \pm 20\%$	5.5	4.5	40	0.796
LB 2518T331□	RoHS	330	$\pm 10\%, \pm 20\%$	4.5	7.0	30	0.796
LB 2518T471□	RoHS	470	$\pm 10\%, \pm 20\%$	3.5	10	25	0.796
LB 2518T681□	RoHS	680	$\pm 10\%, \pm 20\%$	3.0	17	20	0.796
LB 2518T102□	RoHS	1000	$\pm 10\%, \pm 20\%$	2.4	24	15	0.252

Parts number	EHS	Nominal inductance [μ H]	Inductance tolerance	Self-resonant frequency [MHz] (min.)	DC Resistance [Ω] ($\pm 30\%$)	Rated current [mA] (max.)	Measuring frequency [MHz]
LB C2518T1R0M	RoHS	1.0	$\pm 20\%$	100	0.08	775	7.96
LB C2518T1R0MR	RoHS	1.0	$\pm 20\%$	100	0.07	890	7.96
LB C2518T1R5M	RoHS	1.5	$\pm 20\%$	80	0.11	730	7.96
LB C2518T2R2M	RoHS	2.2	$\pm 20\%$	68	0.13	630	7.96
LB C2518T3R3M	RoHS	3.3	$\pm 20\%$	54	0.16	560	7.96
LB C2518T4R7M	RoHS	4.7	$\pm 20\%$	41	0.20	510	7.96
LB C2518T6R8M	RoHS	6.8	$\pm 20\%$	38	0.30	420	7.96
LB C2518T100□	RoHS	10	$\pm 10\%, \pm 20\%$	30	0.36	375	2.52
LB C2518T150□	RoHS	15	$\pm 10\%, \pm 20\%$	23	0.65	285	2.52
LB C2518T220□	RoHS	22	$\pm 10\%, \pm 20\%$	19	0.77	250	2.52
LB C2518T330□	RoHS	33	$\pm 10\%, \pm 20\%$	15	1.5	185	2.52
LB C2518T470□	RoHS	47	$\pm 10\%, \pm 20\%$	12	1.9	165	2.52
LB C2518T680□	RoHS	68	$\pm 10\%, \pm 20\%$	9.5	2.8	140	2.52
LB C2518T101□	RoHS	100	$\pm 10\%, \pm 20\%$	9.0	3.7	125	0.796
LB C2518T151□	RoHS	150	$\pm 10\%, \pm 20\%$	7.0	6.1	95	0.796
LB C2518T221□	RoHS	220	$\pm 10\%, \pm 20\%$	5.5	8.4	80	0.796
LB C2518T331□	RoHS	330	$\pm 10\%, \pm 20\%$	4.5	12.3	65	0.796
LB C2518T471□	RoHS	470	$\pm 10\%, \pm 20\%$	3.5	22	50	0.796
LB C2518T681□	RoHS	680	$\pm 10\%, \pm 20\%$	3.0	28	45	0.796

Parts number	EHS	Nominal inductance [μ H]	Inductance tolerance	Self-resonant frequency [MHz] (min.)	DC Resistance [Ω] ($\pm 30\%$)	Rated current [mA] (max.)	Measuring frequency [MHz]
LB R2518T1R0M	RoHS	1.0	$\pm 20\%$	100	0.045	960	7.96
LB R2518T2R2M	RoHS	2.2	$\pm 20\%$	68	0.07	480	7.96
LB R2518T4R7M	RoHS	4.7	$\pm 20\%$	45	0.10	345	7.96
LB R2518T100□	RoHS	10	$\pm 10\%, \pm 20\%$	30	0.19	235	2.52
LB R2518T220□	RoHS	22	$\pm 10\%, \pm 20\%$	19	0.44	175	2.52
LB R2518T470□	RoHS	47	$\pm 10\%, \pm 20\%$	11	0.84	120	2.52
LB R2518T101□	RoHS	100	$\pm 10\%, \pm 20\%$	9	1.89	80	0.796

□ Please specify the Inductance tolerance code (K or M)

LB/LBC series

Rated Current : The maximum DC value having inductance decrease within 10 % and temperature increase within 20 degC by the application of DC bias.

LBR series

Rated Current : The maximum DC value having inductance decrease within 20 % and temperature increase within 20 degC by the application of DC bias.

▶ This catalog contains the typical specification only due to the limitation of space. When you consider the purchase of our products, please check our product specification sheets. For details of each product (characteristics graph, reliability information, precautions for use, and so on), see our website (<http://www.ty-top.com/>).

PARTS NUMBER

● 3218 (1207) type

Parts number	EHS	Nominal inductance [μ H]	Inductance tolerance	Self-resonant frequency [MHz] (min.)	DC Resistance [Ω] ($\pm 30\%$)	Rated current [mA] (max.)	Measuring frequency [MHz]
LB 3218T1R0M	RoHS	1.0	$\pm 20\%$	100	0.06	1,075	7.96
LB 3218T1R5M	RoHS	1.5	$\pm 20\%$	80	0.07	860	7.96
LB 3218T2R2M	RoHS	2.2	$\pm 20\%$	68	0.09	775	7.96
LB 3218T3R3M	RoHS	3.3	$\pm 20\%$	54	0.11	560	7.96
LB 3218T4R7M	RoHS	4.7	$\pm 20\%$	41	0.13	550	7.96
LB 3218T6R8M	RoHS	6.8	$\pm 20\%$	40	0.17	380	7.96
LB 3218T100□	RoHS	10	$\pm 10\%, \pm 20\%$	30	0.25	340	2.52
LB 3218T150□	RoHS	15	$\pm 10\%, \pm 20\%$	25	0.32	300	2.52
LB 3218T220□	RoHS	22	$\pm 10\%, \pm 20\%$	19	0.49	255	2.52
LB 3218T330□	RoHS	33	$\pm 10\%, \pm 20\%$	15	0.75	215	2.52
LB 3218T470□	RoHS	47	$\pm 10\%, \pm 20\%$	12	0.92	205	2.52
LB 3218T680□	RoHS	68	$\pm 10\%, \pm 20\%$	11	1.49	145	2.52
LB 3218T101□	RoHS	100	$\pm 10\%, \pm 20\%$	8.0	2.4	140	0.796
LB 3218T151□	RoHS	150	$\pm 10\%, \pm 20\%$	7.0	3.2	105	0.796
LB 3218T221□	RoHS	220	$\pm 10\%, \pm 20\%$	5.0	5.4	80	0.796
LB 3218T331□	RoHS	330	$\pm 10\%, \pm 20\%$	4.0	7.0	65	0.796
LB 3218T471□	RoHS	470	$\pm 10\%, \pm 20\%$	3.5	14	54	0.796
LB 3218T681□	RoHS	680	$\pm 10\%, \pm 20\%$	3.0	17	45	0.796
LB 3218T102□	RoHS	1000	$\pm 10\%, \pm 20\%$	2.4	27	39	0.252

● 3225 (1210) type

Parts number	EHS	Nominal inductance [μ H]	Inductance tolerance	Self-resonant frequency [MHz] (min.)	DC Resistance [Ω] ($\pm 30\%$)	Rated current [mA] (max.)	Measuring frequency [MHz]
LB C3225T1R0MR	RoHS	1.0	$\pm 20\%$	250	0.055	1,100	0.1
LB C3225T1R5MR	RoHS	1.5	$\pm 20\%$	220	0.060	1,000	0.1
LB C3225T2R2MR	RoHS	2.2	$\pm 20\%$	190	0.080	930	0.1
LB C3225T3R3MR	RoHS	3.3	$\pm 20\%$	160	0.095	820	0.1
LB C3225T4R7MR	RoHS	4.7	$\pm 20\%$	70	0.100	680	0.1
LB C3225T6R8MR	RoHS	6.8	$\pm 20\%$	50	0.120	620	0.1
LB C3225T100□R	RoHS	10	$\pm 10\%, \pm 20\%$	23	0.133	540	0.1
LB C3225T150□R	RoHS	15	$\pm 10\%, \pm 20\%$	20	0.195	420	0.1
LB C3225T220□R	RoHS	22	$\pm 10\%, \pm 20\%$	17	0.27	330	0.1
LB C3225T330□R	RoHS	33	$\pm 10\%, \pm 20\%$	13	0.41	300	0.1
LB C3225T470□R	RoHS	47	$\pm 10\%, \pm 20\%$	10	0.67	220	0.1
LB C3225T680□R	RoHS	68	$\pm 10\%, \pm 20\%$	8	1.0	190	0.1
LB C3225T101□R	RoHS	100	$\pm 10\%, \pm 20\%$	6	1.4	150	0.1

□ Please specify the Inductance tolerance code (K or M)

LB/LBC series

Rated Current : The maximum DC value having inductance decrease within 10 % and temperature increase within 20 degC by the application of DC bias.

► This catalog contains the typical specification only due to the limitation of space. When you consider the purchase of our products, please check our product specification sheets. For details of each product (characteristics graph, reliability information, precautions for use, and so on), see our website (<http://www.ty-top.com/>).

WIRE-WOUND CHIP INDUCTORS (LB SERIES), WIRE-WOUND CHIP POWER INDUCTORS (CB SERIES), WIRE-WOUND CHIP INDUCTORS FOR SIGNAL LINES (LB SERIES M TYPE)

PACKAGING

① Minimum Quantity

Type	Standard Quantity [pcs]	
	Paper Tape	Embossed Tape
LB C3225	—	1000
CB C3225	—	1000
LB 3218	—	2000
LB R2518	—	2000
LB C2518	—	2000
LB 2518	—	2000
CB 2518	—	2000
CB C2518	—	2000
LBM2016	—	2000
LB C2016	—	2000
LB 2016	—	2000
CB 2016	—	2000
CB C2016	—	2000
LB 2012	—	3000
LB C2012	—	3000
LB R2012	—	3000
CB 2012	—	3000
CB C2012	—	3000
CB L2012	4000	—
LB 1608	4000	—
LBMF1608	—	3000
CBMF1608	—	3000

② Tape material

● Embossed tape

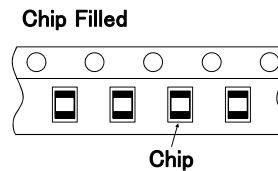

● Card board carrier tape

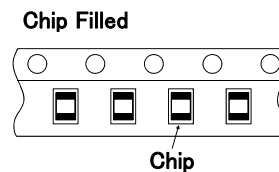
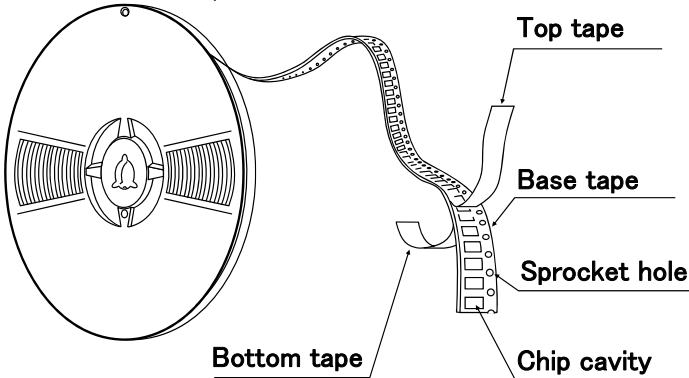

▶ This catalog contains the typical specification only due to the limitation of space. When you consider the purchase of our products, please check our specification. For details of each product (characteristics graph, reliability information, precautions for use, and so on), see our Web site (<http://www.ty-top.com/>).

③ Taping Dimensions

● Embossed Tape (0.315 inches wide)



Type	Chip cavity		Insertion pitch	Tape thickness	
	A	B	F	T	K
LBM2016	1.75 ± 0.1 (0.069 ± 0.004)	2.1 ± 0.1 (0.083 ± 0.004)	4.0 ± 0.1 (0.157 ± 0.004)	0.3 ± 0.05 (0.012 ± 0.002)	1.9max. (0.075max.)
LB C3225 CB C3225	2.8 ± 0.1 (0.110 ± 0.004)	3.5 ± 0.1 (0.138 ± 0.004)	4.0 ± 0.1 (0.157 ± 0.004)	0.3 ± 0.05 (0.012 ± 0.002)	4.0max. (0.157max.)
LB 3218	2.1 ± 0.1 (0.083 ± 0.004)	3.5 ± 0.1 (0.138 ± 0.004)	4.0 ± 0.1 (0.157 ± 0.004)	0.3 ± 0.05 (0.012 ± 0.002)	2.2max. (0.087max.)
LB 2518 CB 2518 LB C2518 CB C2518 LB R2518	2.15 ± 0.1 (0.085 ± 0.004)	2.7 ± 0.1 (0.106 ± 0.004)	4.0 ± 0.1 (0.157 ± 0.004)	0.3 ± 0.05 (0.012 ± 0.002)	2.2max. (0.087max.)
LB 2016 CB 2016 LB C2016 CB C2016	1.75 ± 0.1 (0.069 ± 0.004)	2.1 ± 0.1 (0.083 ± 0.004)	4.0 ± 0.1 (0.157 ± 0.004)	0.3 ± 0.05 (0.012 ± 0.002)	1.9max. (0.075max.)
LB 2012 CB 2012 LB C2012 CB C2012 LB R2012	1.45 ± 0.1 (0.057 ± 0.004)	2.25 ± 0.1 (0.089 ± 0.004)	4.0 ± 0.1 (0.157 ± 0.004)	0.25 ± 0.05 (0.010 ± 0.002)	1.45max. (0.057max.)
LBMF1608 CBMF1608	1.1 ± 0.1 (0.043 ± 0.004)	1.9 ± 0.1 (0.075 ± 0.004)	4.0 ± 0.1 (0.157 ± 0.004)	0.25 ± 0.05 (0.010 ± 0.002)	1.2max. (0.047max.)

Unit: mm (inch)

● Card board carrier tape (0.315 inches wide)



Type	Chip cavity		Insertion pitch	Tape thickness
	A	B	F	T
CB L2012	1.55 ± 0.1 (0.061 ± 0.004)	2.3 ± 0.1 (0.091 ± 0.004)	4.0 ± 0.1 (0.157 ± 0.004)	1.1max. (0.043max.)
LB 1608	1.0 ± 0.1 (0.039 ± 0.004)	1.8 ± 0.1 (0.071 ± 0.004)	4.0 ± 0.1 (0.157 ± 0.004)	1.1max. (0.043max.)

Unit: mm (inch)

④ Leader and Blank Portion



⑤ Reel Size



⑥ Top Tape Strength

The top tape requires a peel-off force 0.2 to 0.7N in the direction of the arrow as illustrated below.



WIRE-WOUND CHIP INDUCTORS (LB SERIES), WIRE-WOUND CHIP POWER INDUCTORS (CB SERIES), WIRE-WOUND CHIP INDUCTORS FOR SIGNAL LINES (LB SERIES M TYPE)

RELIABILITY DATA

1. Operating temperature Range		
Specified Value	LB, LBC, LBR, LBMF Series	-40~ +105°C (Including self-generated heat)
	CB, CBC, CBL, CBMF Series	
	LBM Series	
2. Storage Temperature Range (after soldering)		
Specified Value	LB, LBC, LBR, LBMF Series	-40~ +85°C
	CB, CBC, CBL, CBMF Series	
	LBM Series	
Test Methods and Remarks	LB, CB Series : Please refer the term of "7. storage conditions" in precautions.	
3. Rated Current		
Specified Value	LB, LBC, LBR, LBMF Series	Within the specified tolerance
	CB, CBC, CBL, CBMF Series	
	LBM Series	
4. Inductance		
Specified Value	LB, LBC, LBR, LBMF Series	Within the specified tolerance
	CB, CBC, CBL, CBMF Series	
	LBM Series	
Test Methods and Remarks	LB・LBC・LBR・CB・CBC・CBL・LBMF・CBMF・LBM Series Measuring equipment : LCR Meter (HP4285A or its equivalent) Measuring frequency : Specified frequency	
5. Q		
Specified Value	LB, LBC, LBR, LBMF Series	-
	CB, CBC, CBL, CBMF Series	
	LBM Series	
Test Methods and Remarks	LBM Series Measuring equipment : LCR Meter (HP4285A or its equivalent) Measuring frequency : Specified frequency	
6. DC Resitance		
Specified Value	LB, LBC, LBR, LBMF Series	Within the specified tolerance
	CB, CBC, CBL, CBMF Series	
	LBM Series	
Test Methods and Remarks	Measuring equipment : DC Ohmmeter (HIOKI 3227 or its equivalent)	
7. Self-Resonant Frequency		
Specified Value	LB, LBC, LBR, LBMF Series	Within the specified tolerance
	CB, CBC, CBL, CBMF Series	
	LBM Series	
Test Methods and Remarks	Measuring equipment : Impedance analyzer (HP4291A or its equivalent)	

▶ This catalog contains the typical specification only due to the limitation of space. When you consider the purchase of our products, please check our specification.
For details of each product (characteristics graph, reliability information, precautions for use, and so on), see our Web site (<http://www.ty-top.com/>).

8.Temperature Characteristic					
Specified Value	LBM2016				Inductance change : Within $\pm 5\%$
	LB1608	LB2012	LBR2012	CB2012	Inductance change : Within $\pm 20\%$
	CBL2012	LB2016	CB2016	LB2518	
	LBR2518	CB2518	LBC3225	CBC3225	
	LBMF1608	CBMF1608	LBC2016	CBC2016	Inductance change : Within $\pm 25\%$
LBC2518	CBC2518	LB3218			
Test Methods and Remarks	LBC2012	CBC2012			Inductance change : Within $\pm 35\%$
	Based on the inductance at 20°C and Measured at the ambient of $-40^{\circ}\text{C} \sim +85^{\circ}\text{C}$.				

9.Rasistance to Flexure of Substrate			
Specified Value	LB, LBC, LBR, LBMF Series		No damage.
	CB, CBC, CBL, CBMF Series		
	LBM Series		
Test Methods and Remarks	Warp : 2mm (LB·LBC·LBR·CB·CBC·CBL·LBM·LBMF·CBMF Series)		
	Test substrate : Glass epoxy-resin substrate Thickness : 0.8mm (LB1608·LBMF1608·CBMF1608) : 1.0mm (Others)		

10.Body Strength			
Specified Value	LB, LBC, LBR, LBMF Series		No damage.
	CB, CBC, CBL, CBMF Series		
	LBM Series		
Test Methods and Remarks	LB·LBC·LBR·CB·CBC·CBL·LBM		
	Applied force : 10N Duration : 10sec. LB1608·LBMF1608·CBMF1608 Applied force : 5N Duration : 10sec.		

11.Adhesion of terminal electrode			
Specified Value	LB, LBC, LBR, LBMF Series		No abnormality.
	CB, CBC, CBL, CBMF Series		
	LBM Series		
Test Methods and Remarks	LB·LBC·LBR·CB·CBC·CBL·LBM·LBMF·CBMF		
	Applied force : 10N to X and Y directions Duration : 5 sec. Test substrate : Printed board LB1608·CBMF1608·LBMF1608 Applied force : 5N to X and Y directions Duration : 5 sec. Test substrate : Printed board		

12. Resistance to vibration		
Specified Value	LB, LBC, LBR, LBMF Series	Inductance change : Within $\pm 10\%$ No significant abnormality in appearance.
	CB, CBC, CBL, CBMF Series	
	LBM Series	Inductance change : Within $\pm 5\%$ No significant abnormality in appearance.
Test Methods and Remarks	LB·LBR·LBC·CB·CBC·CBL·LBM·LBMF·CBMF :	
	The given sample is soldered to the board and then it is tested depending on the conditions of the following table.	
	Vibration Frequency	10~55Hz
	Total Amplitude	1.5mm (May not exceed acceleration 196m/s ²)
	Sweeping Method	10Hz to 55Hz to 10Hz for 1min.
	Time	X Y Z For 2 hours on each X, Y, and Z axis.
	Recovery	: At least 2 hrs of recovery under the standard condition after the test, followed by the measurement within 48 hrs.

13. Drop test		
Specified Value	LB, LBC, LBR, LBMF Series	—
	CB, CBC, CBL, CBMF Series	
	LBM Series	

14. Solderability		
Specified Value	LB, LBC, LBR, LBMF Series	At least 90% of surface of terminal electrode is covered by new
	CB, CBC, CBL, CBMF Series	
	LBM Series	
Test Methods and Remarks	LB·LBC·LBR·CB·CBC·CBL·LBM·LBMF·CBMF :	
	Solder temperature	: 245 \pm 5 $^{\circ}$ C
	Duration	: 5 \pm 0.5sec
	Flux	: Methanol solution with 25% of colophony

15. Resistance to soldering		
Specified Value	LB, LBC, LBR, LBMF Series	Inductance change : Within $\pm 10\%$
	CB, CBC, CBL, CBMF Series	
	LBM Series	Inductance change : Within $\pm 5\%$
Test Methods and Remarks	LB·LBC·LBR·CB·CBC·CBL·LBM·LBMF·CBMF :	
	3 times of reflow oven at 230 $^{\circ}$ C MIN for 40sec. with peak temperature at 260 $^{\circ}$ C for 5sec. Recovery : At least 2 hrs of recovery under the standard condition after the test, followed by the measurement within 48 hrs.	

16. Resistance to solvent		
Specified Value	LB, LBC, LBR, LBMF Series	—
	CB, CBC, CBL, CBMF Series	
	LBM Series	
Test Methods and Remarks	Solvent temperature	: Room temperature
	Type of solvent	: Isopropyl alcohol
	Cleaning conditions	: 90s. Immersion and cleaning.

17. Thermal shock			
Specified Value	LB, LBC, LBR, LBMF Series	Inductance change : Within $\pm 10\%$ No significant abnormality in appearance.	
	CB, CBC, CBL, CBMF Series		
	LBM Series		
Test Methods and Remarks	LB·LBC·LBR·CB·CBC·CBL·LBM·LBMF·CBMF :		
	The given sample is soldered to the board and then its Inductance is measured after 100cycles of the following conditions.		
	Conditions of 1 cycle		
	Step	Temperature ($^{\circ}$ C)	Duration (min)
	1	-40 \pm 3	30 \pm 3
	2	Room temperature	Within 3
3	+85 \pm 2	30 \pm 3	
4	Room temperature	Within 3	
	Recovery	: At least 2 hrs of recovery under the standard condition after the test, followed by the measurement within 48 hrs.	

18.Damp heat life test		
Specified Value	LB, LBC, LBR, LBMF Series	Inductance change : Within $\pm 10\%$ No significant abnormality in appearance.
	CB, CBC, CBL, CBMF Series	
	LBM Series	
Test Methods and Remarks	Temperature : $60 \pm 2^\circ\text{C}$ Humidity : $90 \sim 95\% \text{RH}$ Duration : 1000 hrs Recovery : At least 2 hrs of recovery under the standard condition after the test, followed by the measurement within 48 hrs.	

19.Loading under damp heat life test		
Specified Value	LB, LBC, LBR, LBMF Series	Inductance change : Within $\pm 10\%$ No significant abnormality in appearance.
	CB, CBC, CBL, CBMF Series	
	LBM Series	
Test Methods and Remarks	Temperature : $60 \pm 2^\circ\text{C}$ Humidity : $90 \sim 95\% \text{RH}$ Duration : 1000 hrs Applied current : Rated current Recovery : At least 2 hrs of recovery under the standard condition after the test, followed by the measurement within 48 hrs.	

20.High temperature life test		
Specified Value	LB, LBC, LBR, LBMF Series	—
	CB, CBC, CBL, CBMF Series	Inductance change : Within $\pm 10\%$ No significant abnormality in appearance.
	LBM Series	
Test Methods and Remarks	Temperature : $85 \pm 2^\circ\text{C}$ Duration : 1000 hrs Recovery : At least 2 hrs of recovery under the standard condition after the test, followed by the measurement within 48 hrs.	

21.Loading at high temperature life test		
Specified Value	LB, LBC, LBR, LBMF Series	Inductance change : Within $\pm 10\%$ (LBC3225 Series : Within $\pm 20\%$) No significant abnormality in appearance.
	CB, CBC, CBL, CBMF Series	
	LBM Series	—
Test Methods and Remarks	Temperature : $85 \pm 2^\circ\text{C}$ Duration : 1000 hrs Applied current : Rated current Recovery : At least 2 hrs of recovery under the standard condition after the test, followed by the measurement within 48 hrs.	

22.Low temperature life test		
Specified Value	LB, LBC, LBR, LBMF Series	Inductance change : Within $\pm 10\%$ No significant abnormality in appearance.
	CB, CBC, CBL, CBMF Series	
	LBM Series	
Test Methods and Remarks	Temperature : $-40 \pm 2^\circ\text{C}$ Duration : 1000 hrs Recovery : At least 2 hrs of recovery under the standard condition after the test, followed by the measurement within 48 hrs.	

23.Standard condition		
Specified Value	LB, LBC, LBR, LBMF Series	Standard test conditions Unless specified, Ambient temperature is $20 \pm 15^\circ\text{C}$ and the Relative humidity is $65 \pm 20\%$. If there is any doubt about the test results, further measurement shall be had within the following limits: Ambient Temperature: $20 \pm 2^\circ\text{C}$ Relative humidity: $65 \pm 5\%$ Inductance value is based on our standard measurement systems.
	CB, CBC, CBL, CBMF Series	
	LBM Series	

▶ This catalog contains the typical specification only due to the limitation of space. When you consider the purchase of our products, please check our specification.
For details of each product (characteristics graph, reliability information, precautions for use, and so on), see our Web site (<http://www.ty-top.com/>).

WIRE-WOUND CHIP INDUCTORS (LB SERIES), WIRE-WOUND CHIP POWER INDUCTORS (CB SERIES), WIRE-WOUND CHIP INDUCTORS FOR SIGNAL LINES (LB SERIES M TYPE)

■ PRECAUTIONS

1. Circuit Design	
Precautions	<p>◆Operating environment</p> <p>1. The products described in this specification are intended for use in general electronic equipment, (office supply equipment, telecommunications systems, measuring equipment, and household equipment). They are not intended for use in mission-critical equipment or systems requiring special quality and high reliability (traffic systems, safety equipment, aerospace systems, nuclear control systems and medical equipment including life-support systems,) where product failure might result in loss of life, injury or damage. For such uses, contact TAIYO YUDEN Sales Department in advance.</p>
2. PCB Design	
Precautions	<p>◆Land pattern design</p> <p>1. Please contact any of our offices for a land pattern, and refer to a recommended land pattern of a right figure or specifications.</p>
Technical considerations	<p>PRECAUTIONS 【Recommended Land Patterns】</p> <p>Surface Mounting</p> <ul style="list-style-type: none"> • Mounting and soldering conditions should be checked beforehand. • Applicable soldering process to those products is reflow soldering only.
3. Considerations for automatic placement	
Precautions	<p>◆Adjustment of mounting machine</p> <p>1. Excessive impact load should not be imposed on the products when mounting onto the PC boards.</p> <p>2. Mounting and soldering conditions should be checked beforehand.</p>
Technical considerations	<p>1. When installing products, care should be taken not to apply distortion stress as it may deform the products.</p>
4. Soldering	
Precautions	<p>◆Reflow soldering(LB and CB Types)</p> <p>1. For reflow soldering with either leaded or lead-free solder, the profile specified in "point for controlling" is recommended.</p> <p>◆Recommended conditions for using a soldering iron</p> <p>1. Put the soldering iron on the land-pattern. Soldering iron's temperature - Below 350°C Duration-3 seconds or less. The soldering iron should not come in contact with inductor directly.</p>
Technical considerations	<p>◆Reflow soldering(LB and CB Types)</p> <p>1. Reflow profile</p> <p>Temperature [°C]</p> <p>Heating Time [sec]</p> <p>150~180</p> <p>90±30sec</p> <p>30±10sec</p> <p>230°C min</p> <p>5sec max</p> <p>Peak: 260+0/-5°C</p> <p>◆Recommended conditions for using a soldering iron</p> <p>1. Components can be damaged by excessive heat where soldering conditions exceed the specified range.</p>
5. Cleaning	
Precautions	<p>◆Cleaning conditions</p> <p>Washing by supersonic waves shall be avoided.</p>
Technical considerations	<p>◆Cleaning conditions</p> <p>If washed by supersonic waves, the products might be broken.</p>

6. Handling	
Precautions	<ul style="list-style-type: none"> ◆ Handling <ol style="list-style-type: none"> 1. Keep the inductors away from all magnets and magnetic objects. ◆ Breakaway PC boards (splitting along perforations) <ol style="list-style-type: none"> 1. When splitting the PC board after mounting inductors, care should be taken not to give any stresses of deflection or twisting to the board. 2. Board separation should not be done manually, but by using the appropriate devices. ◆ Mechanical considerations <ol style="list-style-type: none"> 1. Please do not give the inductors any excessive mechanical shocks.
Technical considerations	<ul style="list-style-type: none"> ◆ Handling <ol style="list-style-type: none"> 1. There is a case that a characteristic varies with magnetic influence. ◆ Breakaway PC boards (splitting along perforations) <ol style="list-style-type: none"> 1. Planning pattern configurations and the position of products should be carefully performed to minimize stress. ◆ Mechanical considerations <ol style="list-style-type: none"> 1. There is a case to be damaged by a mechanical shock.

7. Storage conditions	
Precautions	<ul style="list-style-type: none"> ◆ Storage <ol style="list-style-type: none"> 1. To maintain the solderability of terminal electrodes and to keep the packing material in good condition, temperature and humidity in the storage area should be controlled. <ul style="list-style-type: none"> • Recommended conditions <ul style="list-style-type: none"> Ambient temperature : 0~40°C Humidity : Below 70% RH • The ambient temperature must be kept below 30°C. Even under ideal storage conditions, solderability of products electrodes may decrease as time passes. <ul style="list-style-type: none"> For this reason, product should be used within 6 months from the time of delivery. In case of storage over 6 months, solderability shall be checked before actual usage.
Technical considerations	<ul style="list-style-type: none"> ◆ Storage <ol style="list-style-type: none"> 1. Under a high temperature and humidity environment, problems such as reduced solderability caused by oxidation of terminal electrodes and deterioration of taping/packaging materials may take place.

Mouser Electronics

Authorized Distributor

Click to View Pricing, Inventory, Delivery & Lifecycle Information:

[Taiyo Yuden:](#)

[LB2012T150M](#) [LB2012T680M](#)