

## Schottky Barrier Rectifier

### FEATURES

- Low forward voltage drop
- Low power loss, high efficiency
- Guardring for overvoltage protection
- High surge current capability
- For use as Bypass diode in Solar application.
- Compliant to RoHS Directive 2011/65/EU and in accordance to WEEE 2002/96/EC
- Halogen-free according to IEC 61249-2-21 definition

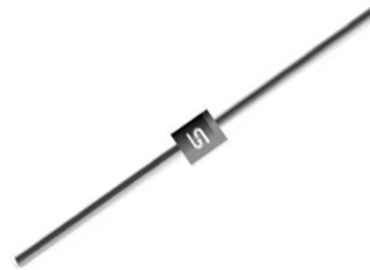

**R-6**

### MECHANICAL DATA

**Case:** R-6

Molding compound, UL flammability classification rating 94V-0

Base P/N with suffix "G" on packing code - halogen-free

Base P/N with prefix "H" on packing code - AEC-Q101 qualified

**Terminal:** Matte tin plated leads, solderable per JESD22-B102

Meet JESD 201 class 1A whisker test

with prefix "H" on packing code meet JESD 201 class 2 whisker test

**Weight:** 1.6 g (approximately)

MAXIMUM RATINGS AND ELECTRICAL CHARACTERISTICS (T <sub>A</sub> =25°C unless otherwise noted)			
PARAMETER	SYMBOL	SK15H45	UNIT
Maximum repetitive peak reverse voltage	V <sub>RRM</sub>	45	V
Maximum RMS voltage	V <sub>RMS</sub>	31	V
Maximum DC blocking voltage	V <sub>DC</sub>	45	V
Maximum average forward rectified current	I <sub>F(AV)</sub>	15	A
Peak forward surge current, 8.3 ms single half sine-wave superimposed on rated load (JEDEC method)	I <sub>FSM</sub>	340	A
Maximum instantaneous forward voltage (Note 1) I <sub>F</sub> =15A	V <sub>F</sub>	0.56	V
Maximum DC reverse current at rated DC blocking voltage	I <sub>R</sub>	0.15 20	mA
Typical thermal resistance	R <sub>θJC</sub>	10	°C/W
	R <sub>θJA</sub>	30	
Junction temperature range - in DC forward mode	T <sub>J</sub>	≤200	°C
Storage temperature range	T <sub>STG</sub>	- 55 to +175	°C

Note 1: Pulse test with PW=300μs, 1% duty cycle

ORDERING INFORMATION					
PART NO.	AEC-Q101 QUALIFIED	PACKING CODE	GREEN COMPOUND CODE	PACKAGE	PACKING
SK15H45	Prefix "H"	A0	Suffix "G"	R-6	700 / Ammo box
		R0		R-6	1,000 / 13" Paper reel
		B0		R-6	400 / Bulk packing

EXAMPLE					
PREFERRED P/N	PART NO.	AEC-Q101 QUALIFIED	PACKING CODE	GREEN COMPOUND CODE	DESCRIPTION
SK15H45 A0	SK15H45		A0		
SK15H45 A0G	SK15H45		A0	G	Green compound
SK15H45HA0	SK15H45	H	A0		AEC-Q101 qualified

**RATINGS AND CHARACTERISTICS CURVES**

(TA=25°C unless otherwise noted)

FIG. 1 FORWARD CURRENT DERATING CURVE

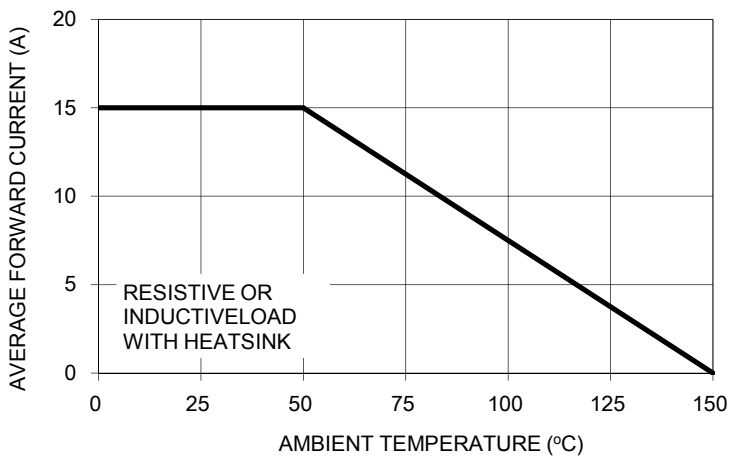

FIG. 2 MAXIMUM NON-REPETITIVE FORWARD SURGE CURRENT

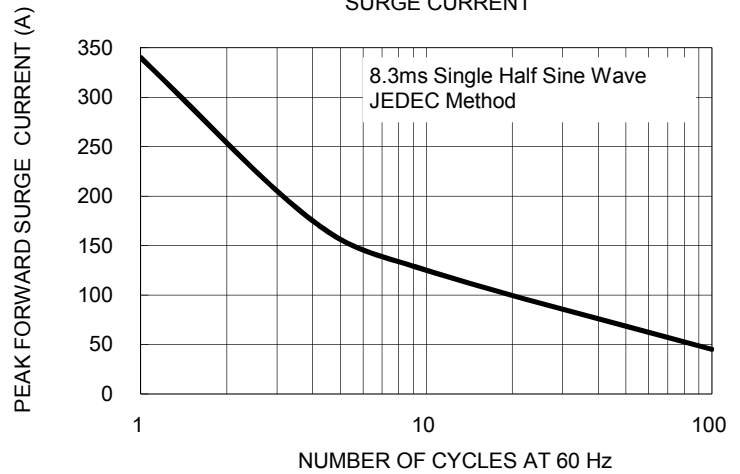

FIG. 3 TYPICAL FORWARD CHARACTERISTICS

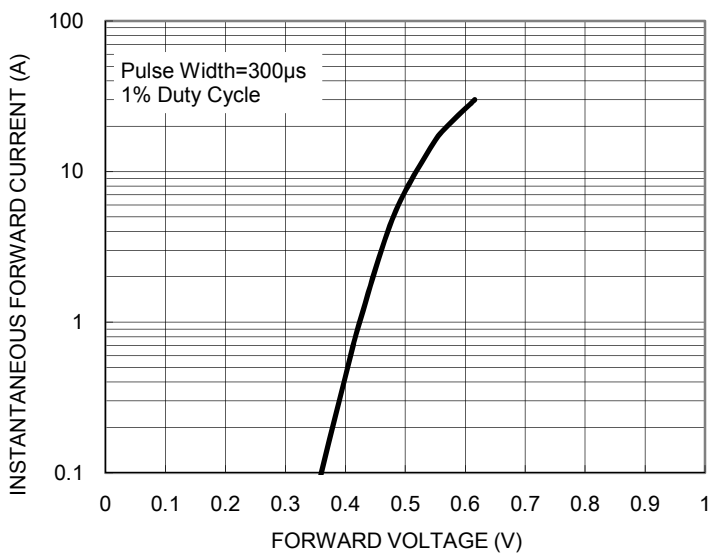

FIG. 4 TYPICAL REVERSE CHARACTERISTICS

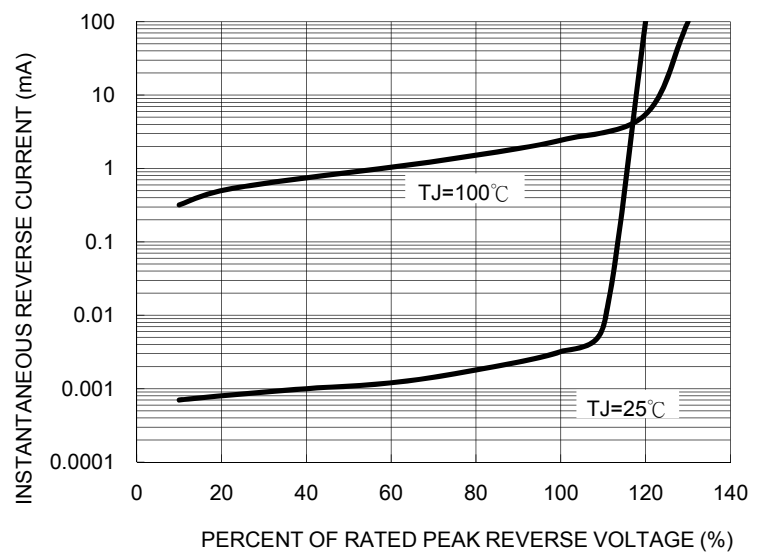

FIG. 5 TYPICAL JUNCTION CAPACITANCE

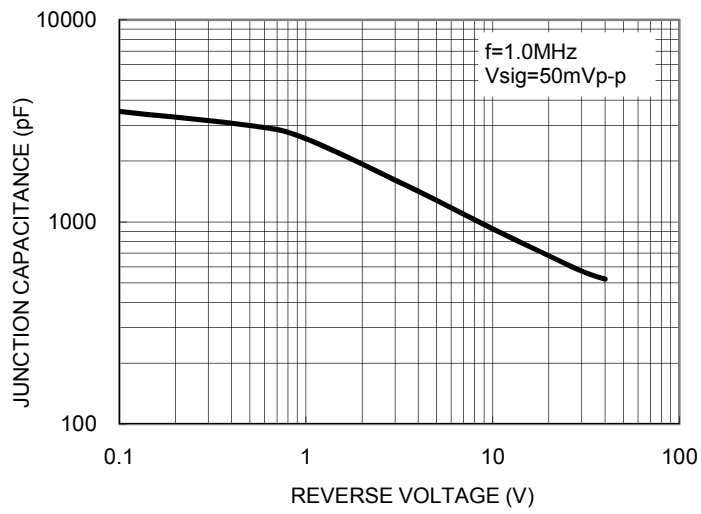
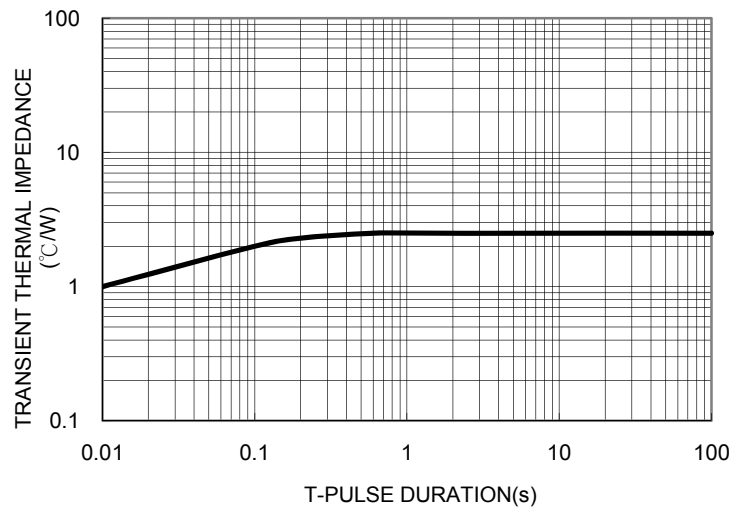
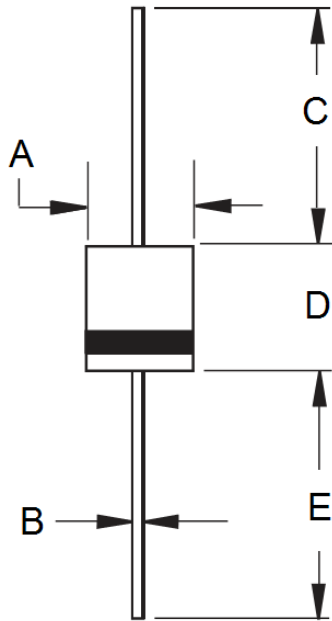

FIG. 6 TYPICAL TRANSIENT THERMAL IMPEDANCE



PACKAGE OUTLINE DIMENSIONS



DIM.	Unit (mm)		Unit (inch)	
	Min	Max	Min	Max
A	6.80	7.20	0.268	0.283
B	1.20	1.30	0.047	0.051
C	25.40	-	1.000	-
D	8.60	9.10	0.339	0.358
E	25.40	-	1.000	-

MARKING DIAGRAM



P/N = Specific Device Code  
 G = Green Compound  
 YWW = Date Code  
 F = Factory Code

## Notice

Specifications of the products displayed herein are subject to change without notice. TSC or anyone on its behalf, assumes no responsibility or liability for any errors inaccuracies.

Information contained herein is intended to provide a product description only. No license, express or implied, to any intellectual property rights is granted by this document. Except as provided in TSC's terms and conditions of sale for such products, TSC assumes no liability whatsoever, and disclaims any express or implied warranty, relating to sale and/or use of TSC products including liability or warranties relating to fitness for a particular purpose, merchantability, or infringement of any patent, copyright, or other intellectual property right.

The products shown herein are not designed for use in medical, life-saving, or life-sustaining applications. Customers using or selling these products for use in such applications do so at their own risk and agree to fully indemnify TSC for any damages resulting from such improper use or sale.

# Mouser Electronics

Authorized Distributor

Click to View Pricing, Inventory, Delivery & Lifecycle Information:

[Taiwan Semiconductor:](#)

[SK15H45HR0](#)