

## N-Channel Power MOSFET

600V, 7A, 0.6Ω

### FEATURES

- Super-Junction technology
- High performance due to small figure-of-merit
- High ruggedness performance
- High commutation performance
- Pb-free plating
- Compliant to RoHS Directive 2011/65/EU and in accordance to WEEE 2002/96/EC
- Halogen-free according to IEC 61249-2-21

### APPLICATIONS

- Power Supply
- Lighting

KEY PERFORMANCE PARAMETERS		
PARAMETER	VALUE	UNIT
$V_{DS}$	600	V
$R_{DS(on)}$ (max)	0.6	Ω
$Q_g$	13	nC



TO-251 (IPAK)

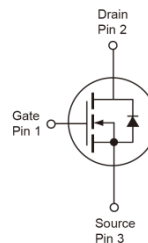
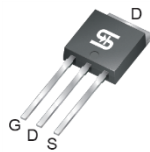

ABSOLUTE MAXIMUM RATINGS ( $T_A = 25^\circ\text{C}$ unless otherwise noted)			
PARAMETER	SYMBOL	LIMIT	UNIT
Drain-Source Voltage	$V_{DS}$	600	V
Gate-Source Voltage	$V_{GS}$	±30	V
Continuous Drain Current <sup>(Note 1)</sup>	$I_D$	$T_C = 25^\circ\text{C}$	7
		$T_C = 100^\circ\text{C}$	4.4
Pulsed Drain Current <sup>(Note 2)</sup>	$I_{DM}$	21	A
Total Power Dissipation @ $T_C = 25^\circ\text{C}$	$P_{DTOT}$	63	W
Single Pulsed Avalanche Energy <sup>(Note 3)</sup>	$E_{AS}$	36	mJ
Single Pulsed Avalanche Current <sup>(Note 3)</sup>	$I_{AS}$	1.2	A
Operating Junction and Storage Temperature Range	$T_J, T_{STG}$	- 55 to +150	°C

THERMAL PERFORMANCE				
PARAMETER	SYMBOL	DPAK	IPAK	UNIT
Junction to Case Thermal Resistance	$R_{\theta JC}$	2		°C/W
Junction to Ambient Thermal Resistance	$R_{\theta JA}$	62		°C/W

**Thermal Performance Note:**  $R_{\theta JA}$  is the sum of the junction-to-case and case-to-ambient thermal resistances. The case-thermal reference is defined at the solder mounting surface of the drain pins.  $R_{\theta JA}$  is guaranteed by design while  $R_{\theta CA}$  is determined by the user's board design.  $R_{\theta JA}$  shown below for single device operation on FR-4 PCB in still air.

**ELECTRICAL SPECIFICATIONS** ( $T_A = 25^\circ\text{C}$  unless otherwise noted)

PARAMETER	CONDITIONS	SYMBOL	MIN	TYP	MAX	UNIT
<b>Static</b>						
Drain-Source Breakdown Voltage	$V_{GS} = 0V, I_D = 250\mu A$	$BV_{DSS}$	600	--	--	V
Gate Threshold Voltage	$V_{DS} = V_{GS}, I_D = 250\mu A$	$V_{GS(TH)}$	2	3.4	4	V
Gate Body Leakage	$V_{GS} = \pm 30V, V_{DS} = 0V$	$I_{GSS}$	--	--	$\pm 100$	nA
Zero Gate Voltage Drain Current	$V_{DS} = 600V, V_{GS} = 0V$	$I_{DSS}$	--	--	1	$\mu A$
Drain-Source On-State Resistance (Note 4)	$V_{GS} = 10V, I_D = 2.1A$	$R_{DS(on)}$	--	0.45	0.6	$\Omega$
<b>Dynamic</b> (Note 5)						
Total Gate Charge	$V_{DS} = 380V, I_D = 7A,$ $V_{GS} = 10V$	$Q_g$	--	13	--	nC
Gate-Source Charge		$Q_{gs}$	--	3.36	--	
Gate-Drain Charge		$Q_{gd}$	--	5.56	--	
Input Capacitance	$V_{DS} = 100V, V_{GS} = 0V,$ $f = 1.0MHz$	$C_{iss}$	--	516	--	$\mu F$
Output Capacitance		$C_{oss}$	--	55	--	
Gate Resistance	$F = 1MHz, \text{open drain}$	$R_g$	--	3.2	--	$\Omega$
<b>Switching</b> (Note 6)						
Turn-On Delay Time	$V_{DD} = 380V,$ $R_{GEN} = 25\Omega,$ $I_D = 7A, V_{GS} = 10V$	$t_{d(on)}$	--	20.8	--	ns
Turn-On Rise Time		$t_r$	--	10	--	
Turn-Off Delay Time		$t_{d(off)}$	--	43	--	
Turn-Off Fall Time		$t_f$	--	8.4	--	
<b>Source-Drain Diode</b>						
Forward Voltage (Note 4)	$I_S = 7A, V_{GS} = 0V$	$V_{SD}$	--	--	1.4	V
Reverse Recovery Time	$V_R = 100V, I_S = 7A$ $di_f/dt = 100A/\mu s$	$t_{rr}$	--	232.5	--	ns
Reverse Recovery Charge		$Q_{rr}$	--	2.16	--	$\mu C$

**Notes:**

- Current limited by package.
- Pulse width limited by the maximum junction temperature.
- $L = 50mH, I_{AS} = 1.2A, V_{DD} = 50V, R_G = 25\Omega, \text{Starting } T_J = 25^\circ\text{C}$
- Pulse test:  $PW \leq 300\mu s, \text{duty cycle} \leq 2\%$ .
- For DESIGN AID ONLY, not subject to production testing.
- Switching time is essentially independent of operating temperature.

**ORDERING INFORMATION**

PART NO.	PACKAGE	PACKING
TSM60NB600CH C5G	TO-251 (IPAK)	75pcs / Tube

**CHARACTERISTICS CURVES**

( $T_C = 25^\circ\text{C}$  unless otherwise noted)

**Output Characteristics**

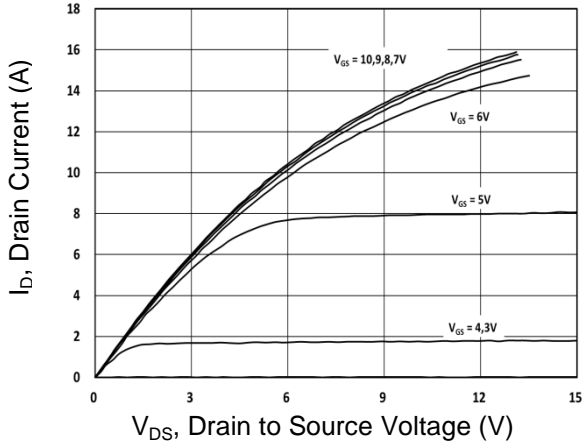

**Transfer Characteristics**

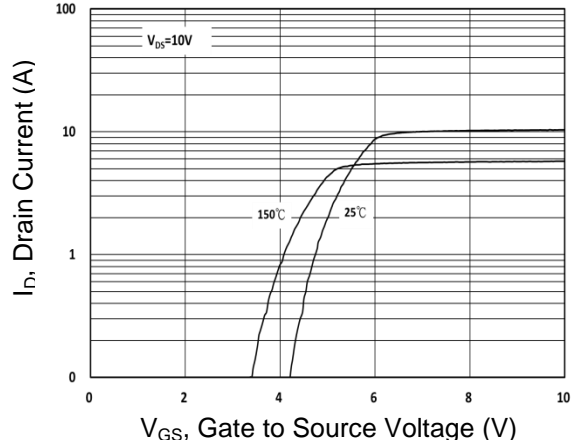

**On-Resistance vs. Drain Current**

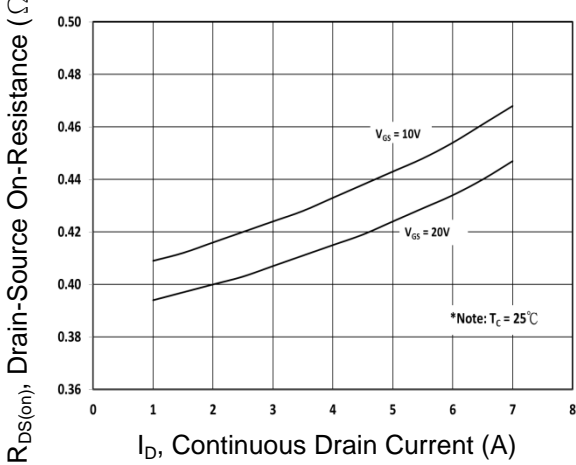

**Gate-Source Voltage vs. Gate Charge**

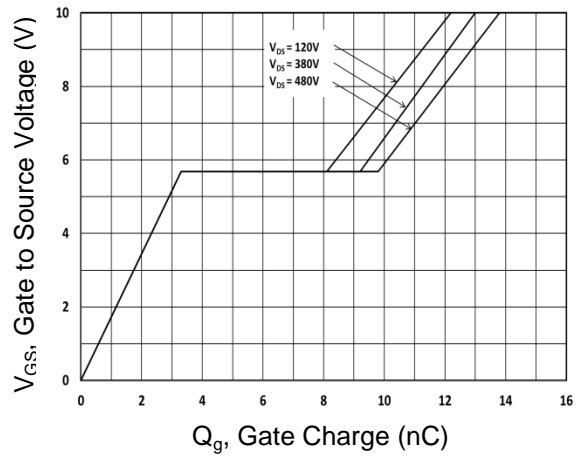

**On-Resistance vs. Junction Temperature**

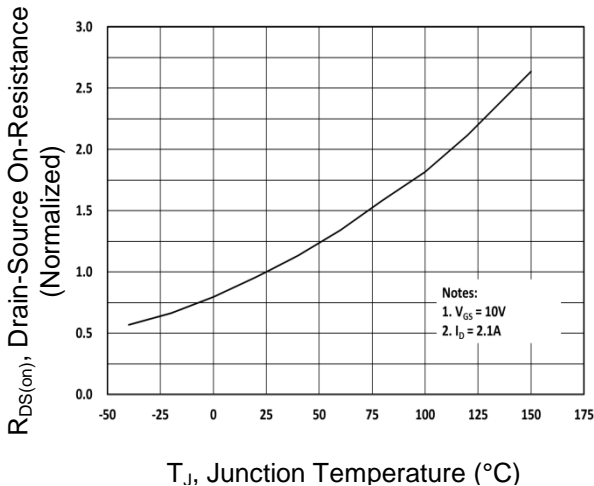

**Source-Drain Diode Forward Current vs. Voltage**

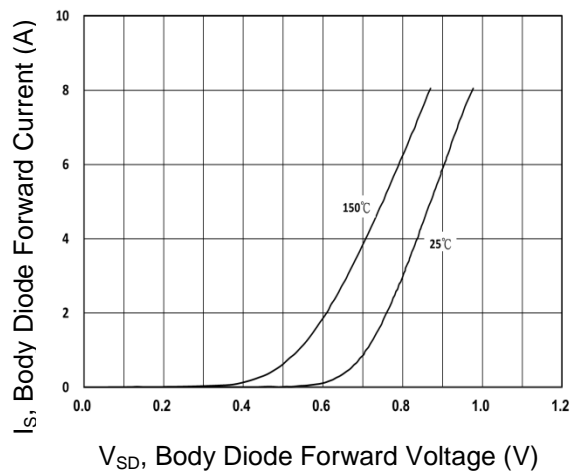

**CHARACTERISTICS CURVES**

( $T_C = 25^\circ\text{C}$  unless otherwise noted)

**Capacitance vs. Drain-Source Voltage**

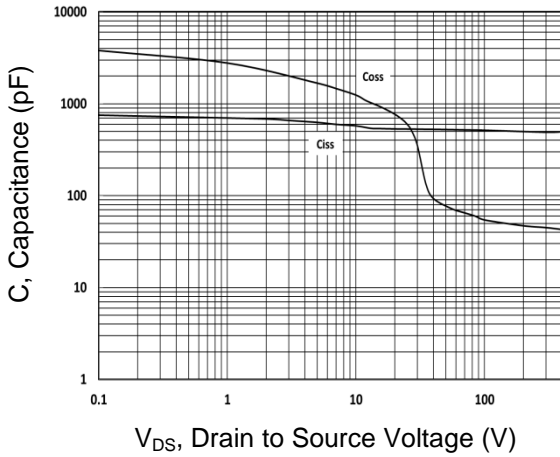

**$BV_{DSS}$  vs. Junction Temperature**

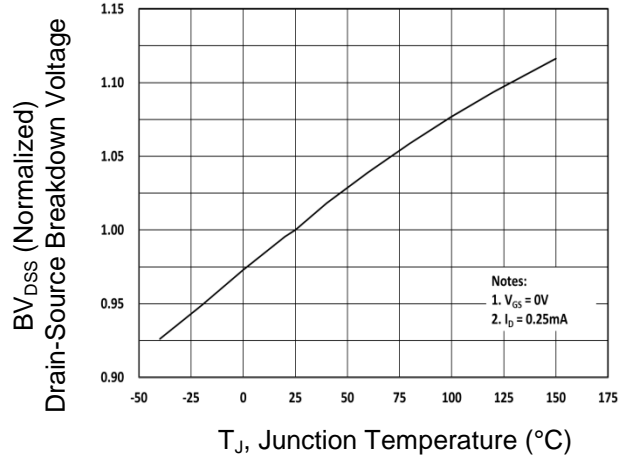

**Maximum Safe Operating Area**

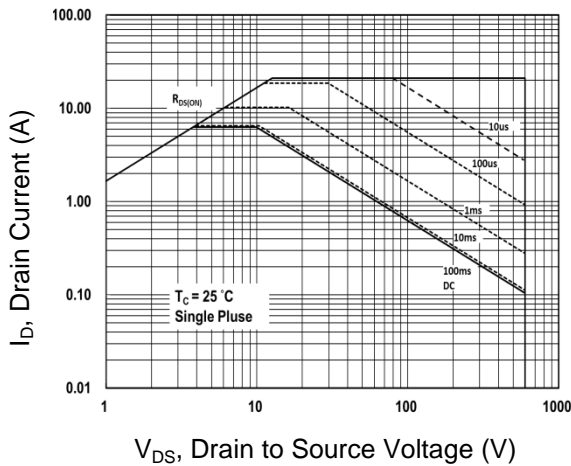

**Normalized Thermal Transient Impedance, Junction-to-Case**

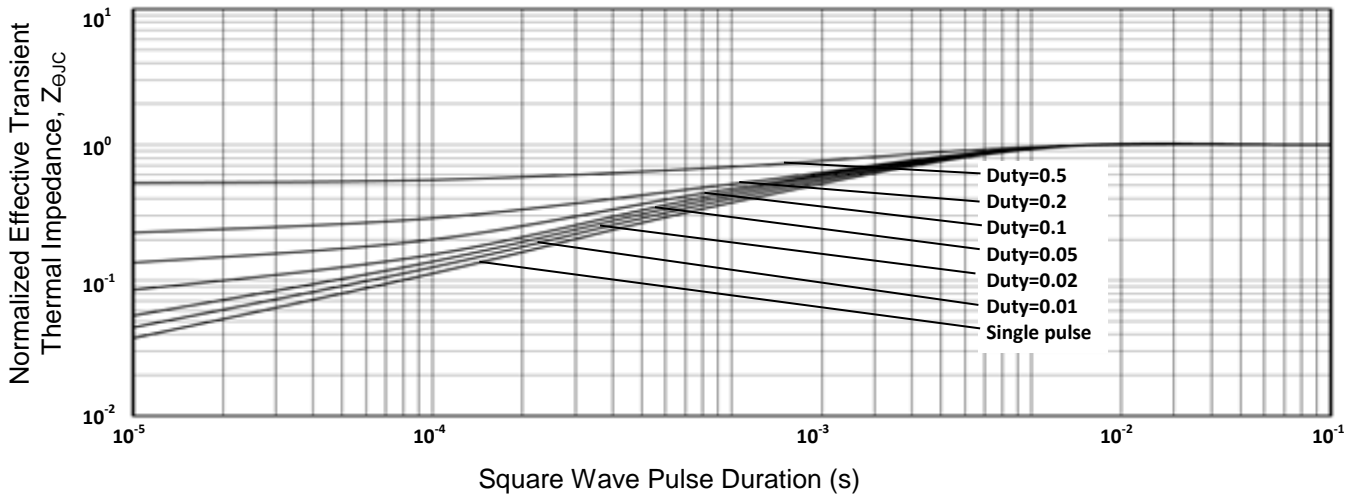

**PACKAGE OUTLINE DIMENSIONS** (Unit: Millimeters)

**TO-251 (IPAK)**

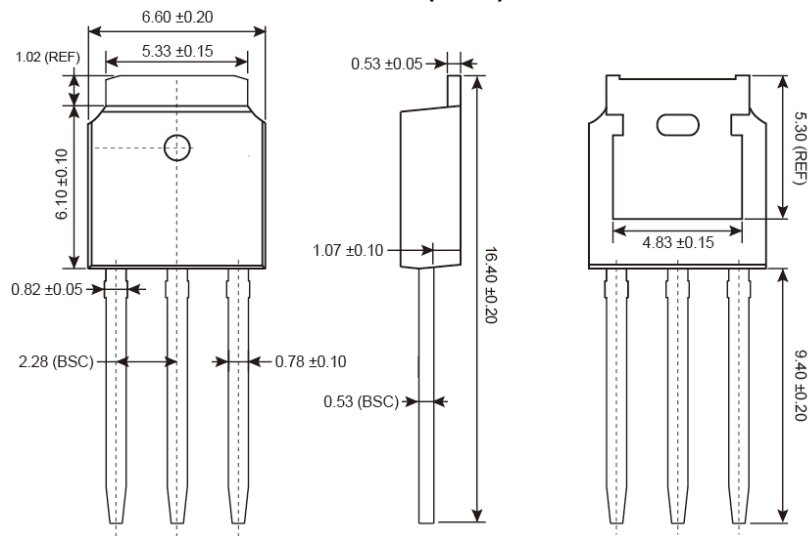

**MARKING DIAGRAM**

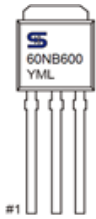

- Y** = Year Code
- M** = Month Code for Halogen Free Product
  - O** =Jan    **P** =Feb    **Q** =Mar    **R** =Apr
  - S** =May    **T** =Jun    **U** =Jul    **V** =Aug
  - W** =Sep    **X** =Oct    **Y** =Nov    **Z** =Dec
- L** = Lot Code (1~9, A~Z)

## Notice

Specifications of the products displayed herein are subject to change without notice. TSC or anyone on its behalf, assumes no responsibility or liability for any errors or inaccuracies.

Information contained herein is intended to provide a product description only. No license, express or implied, to any intellectual property rights is granted by this document. Except as provided in TSC's terms and conditions of sale for such products, TSC assumes no liability whatsoever, and disclaims any express or implied warranty, relating to sale and/or use of TSC products including liability or warranties relating to fitness for a particular purpose, merchantability, or infringement of any patent, copyright, or other intellectual property right.

The products shown herein are not designed for use in medical, life-saving, or life-sustaining applications. Customers using or selling these products for use in such applications do so at their own risk and agree to fully indemnify TSC for any damages resulting from such improper use or sale.

# Mouser Electronics

Authorized Distributor

Click to View Pricing, Inventory, Delivery & Lifecycle Information:

[Taiwan Semiconductor:](#)

[TSM60NB600CH C5G](#)