

200mW, 5% Tolerance SMD Zener Diode

FEATURES

- Wide Zener voltage range selection: 2.4V to 75V
- V_Z tolerance selection of $\pm 5\%$
- Moisture sensitivity level: level 1, per J-STD-020
- RoHS Compliant

APPLICATIONS

- Low voltage stabilizers or voltage references
- Adapters
- On-board DC/DC converter

MECHANICAL DATA

- Case: SOD-323F
- Molding compound meets UL 94 V-0 flammability rating
- Terminal: Matte tin plated leads, solderable per J-STD-002
- Meet JESD 201 class 1A whisker test
- Polarity: Indicated by cathode band
- Weight: 4.60mg (approximately)

KEY PARAMETERS		
PARAMETER	VALUE	UNIT
V_Z	2.4 - 75	V
P_D	200	mW
V_F at $I_F = 10\text{mA}$	1	V
$T_{J\text{ MAX}}$	150	$^{\circ}\text{C}$
Package	SOD-323F	
Configuration	Single die	



SOD-323F



ABSOLUTE MAXIMUM RATINGS ($T_A = 25^{\circ}\text{C}$ unless otherwise noted)			
PARAMETER	SYMBOL	VALUE	UNIT
Forward voltage @ $I_F = 10\text{mA}$	V_F	1	V
Power dissipation	P_D	200	mW
Junction temperature range	T_J	-65 to +150	$^{\circ}\text{C}$
Storage temperature range	T_{STG}	-65 to +150	$^{\circ}\text{C}$

THERMAL PERFORMANCE			
PARAMETER	SYMBOL	TYP	UNIT
Junction-to-ambient thermal resistance	$R_{\theta JA}$	625	$^{\circ}\text{C/W}$

ELECTRICAL SPECIFICATIONS ($T_A = 25^\circ\text{C}$ unless otherwise noted)

PART NUMBER	MARKING CODE	ZENER VOLTAGE			TEST CURRENT	REGULAR IMPEDANCE		TEST CURRENT	LEAKAGE CURRENT	
		$V_Z @ I_{ZT}^{(1)}$			I_{ZT}	$Z_{ZT} @ I_{ZT}$	$Z_{ZK} @ I_{ZK}$	I_{ZK}	$I_R @ V_R$	
		V			mA	Ω	Ω	mA	μA	V
		Min	Nom	Max		Max	Max		Max	
BZT52C2V4S	Z0	2.28	2.40	2.52	5	100	564	1	45	1
BZT52C2V7S	Z1	2.57	2.70	2.84	5	100	564	1	18	1
BZT52C3V0S	Z2	2.85	3.00	3.15	5	100	564	1	9	1
BZT52C3V3S	Z3	3.14	3.30	3.47	5	95	564	1	4.5	1
BZT52C3V6S	Z4	3.42	3.60	3.78	5	90	564	1	4.5	1
BZT52C3V9S	Z5	3.71	3.90	4.10	5	90	564	1	2.7	1
BZT52C4V3S	Z6	4.09	4.30	4.52	5	90	564	1	2.7	1
BZT52C4V7S	Z7	4.47	4.70	4.94	5	80	470	1	2.7	2.0
BZT52C5V1S	Z8	4.85	5.10	5.36	5	60	451	1	1.8	2.0
BZT52C5V6S	Z9	5.32	5.60	5.88	5	40	376	1	0.9	2.0
BZT52C6V2S	ZA	5.89	6.20	6.51	5	10	141	1	2.7	4.0
BZT52C6V8S	ZB	6.46	6.80	7.14	5	15	75	1	1.8	4.0
BZT52C7V5S	ZC	7.11	7.50	7.86	5	15	75	1	0.9	5.0
BZT52C8V2S	ZD	7.79	8.20	8.61	5	15	75	1	0.63	5.0
BZT52C9V1S	ZE	8.65	9.10	9.56	5	15	94	1	0.45	6.0
BZT52C10S	ZF	9.50	10	10.50	5	20	141	1	0.18	7.0
BZT52C11S	ZG	10.45	11	11.55	5	20	141	1	0.09	8.0
BZT52C12S	ZH	11.40	12	12.60	5	25	141	1	0.09	8.0
BZT52C13S	ZJ	12.35	13	13.65	5	30	160	1	0.09	8.0
BZT52C15S	ZK	14.25	15	15.75	5	30	188	1	0.045	10.5
BZT52C16S	ZL	15.20	16	16.80	5	40	188	1	0.045	11.2
BZT52C18S	ZM	17.10	18	18.90	5	45	212	1	0.045	12.6
BZT52C20S	ZN	19.00	20	21.00	5	55	212	1	0.045	14.0
BZT52C22S	ZP	20.90	22	23.10	5	55	235	1	0.045	15.4
BZT52C24S	ZR	22.80	24	25.20	5	70	235	1	0.045	16.8
BZT52C27S	ZS	25.65	27	28.35	2	80	282	0.5	0.045	18.9
BZT52C30S	ZT	28.50	30	31.50	2	80	282	0.5	0.045	21.0
BZT52C33S	ZU	31.35	33	34.65	2	80	306	0.5	0.045	23.0
BZT52C36S	ZV	34.20	36	37.80	2	90	329	0.5	0.045	25.2
BZT52C39S	ZW	37.05	39	40.95	2	130	329	0.5	0.045	27.3
BZT52C43S	ZX	40.85	43	45.15	2	150	353	0.5	0.045	30.1
BZT52C47S	ZY	44.65	47	49.35	2	170	353	0.5	0.045	33.0
BZT52C51S	Z-	48.45	51	53.55	2	180	376	0.5	0.045	35.7
BZT52C56S	Z=	53.20	56	58.80	2	200	400	0.5	0.045	39.2
BZT52C62S	Z≡	58.90	62	65.10	2	215	423	0.5	0.045	43.4
BZT52C68S	Z>	64.60	68	71.40	2	240	447	0.5	0.045	47.6
BZT52C75S	Z<	71.25	75	78.75	2	255	470	0.5	0.045	52.5

Notes:

1. The Zener voltage (V_Z) is tested under pulse condition of 30ms.
2. The device numbers listed have a standard tolerance on the normal Zener voltage of $\pm 5\%$.
3. For detailed information on price, availability and delivery of normal Zener voltages between the voltages shown and tighter voltage tolerances, contact your nearest Taiwan Semiconductor representative.
4. The Zener impedance is derived from the 60-cycle AC voltage, which results when an AC current having an RMS value equal to 10% of the DC Zener current (I_{ZT} or I_{ZK}) is superimposed to I_{ZT} or I_{ZK} .

ORDERING INFORMATION		
ORDERING CODE⁽¹⁾⁽²⁾	PACKAGE	PACKING
BZT52CxS RRG	SOD-323F	3,000 / 7" Tape & Reel
BZT52CxS RR	SOD-323F	3,000 / 7" Tape & Reel
BZT52CxS R9G	SOD-323F	10,000 / 13" Tape & Reel
BZT52CxS R9	SOD-323F	10,000 / 13" Tape & Reel

Notes:

1. "x" defines voltage from 2.4V (BZT52C2V4S) to 75V (BZT52C75S)
2. "G" means green compound (halogen-free according to IEC 61249-2-21)

CHARACTERISTICS CURVES

($T_A = 25^\circ\text{C}$ unless otherwise noted)

Fig.1 Typical Forward Characteristics

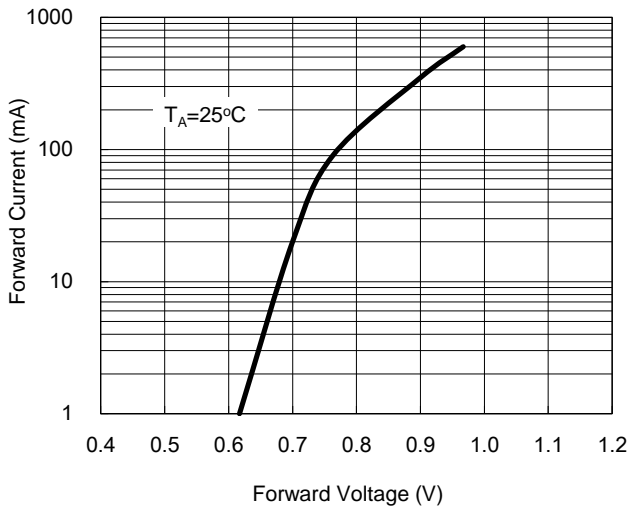

Fig. 2 Zener Breakdown Characteristics

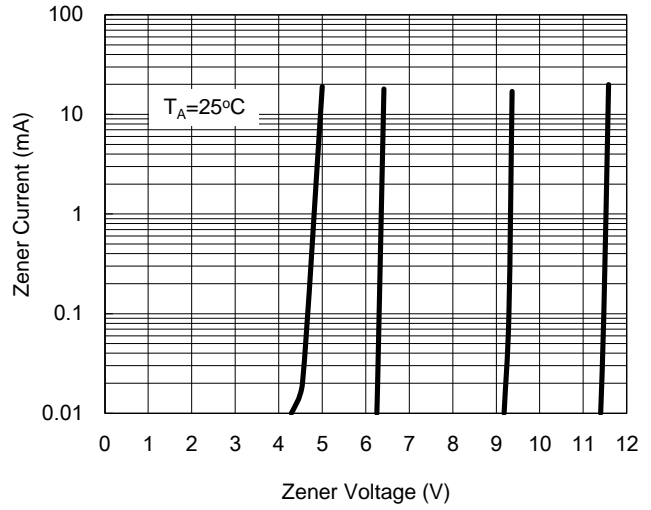

Fig. 3 Zener Breakdown Characteristics

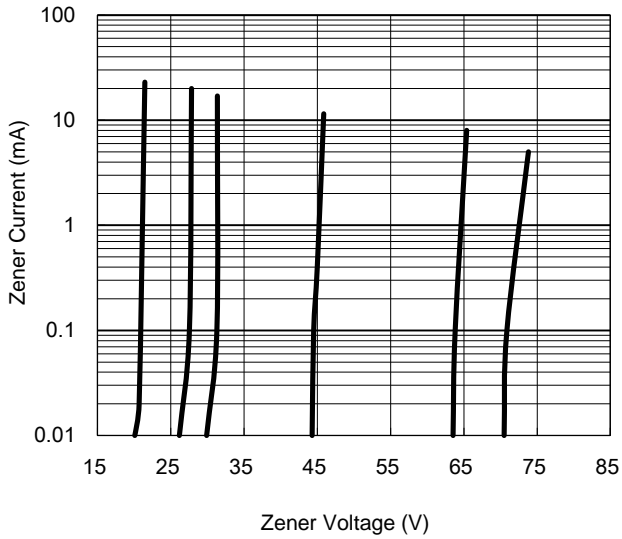
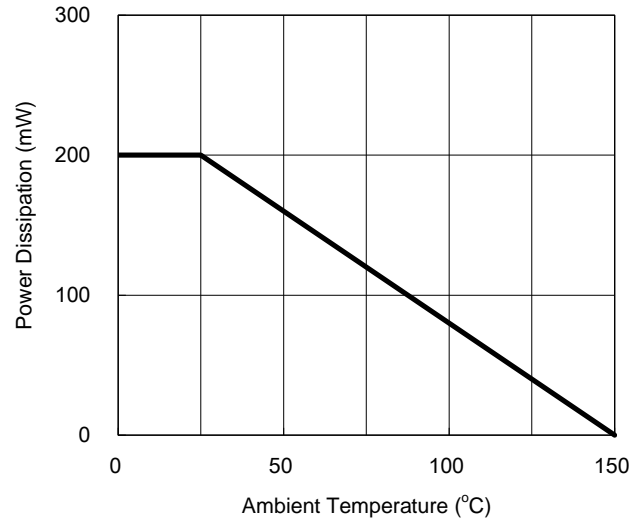

Fig.4 Power Dissipation Curve



CHARACTERISTICS CURVES

($T_A = 25^\circ\text{C}$ unless otherwise noted)

Fig.5 Typical Capacitance

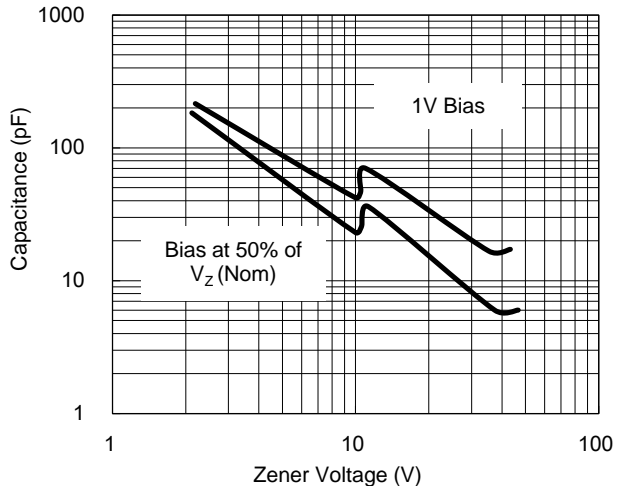
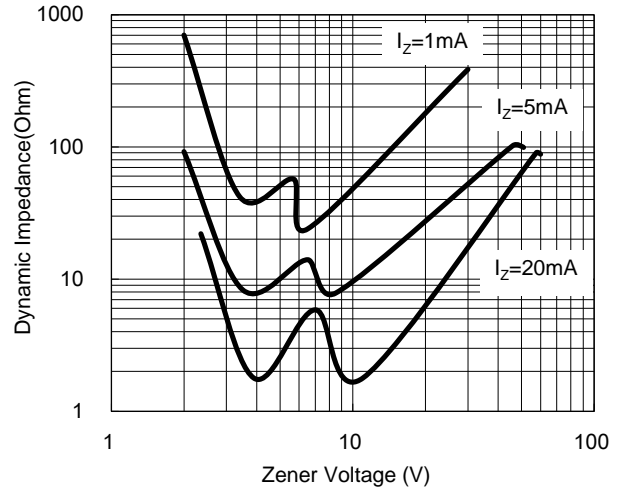
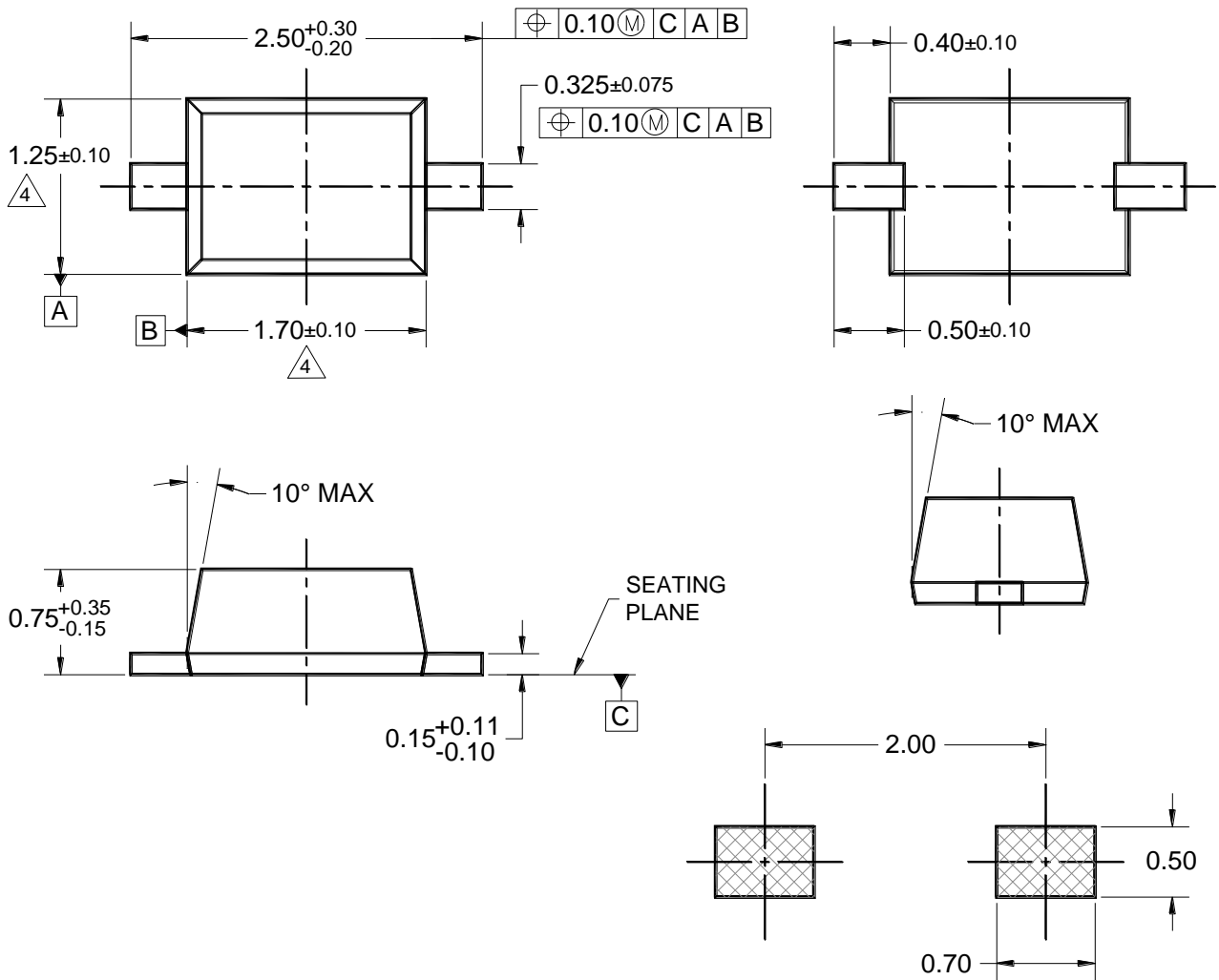

Fig.6 Effect of Zener Voltage on Impedance



PACKAGE OUTLINE DIMENSIONS

SOD-323F



SUGGESTED PAD LAYOUT

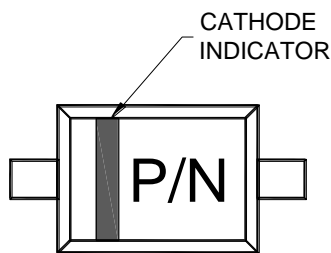

MARKING DIAGRAM

P/N = MARKING CODE

NOTES: UNLESS OTHERWISE SPECIFIED

1. ALL DIMENSIONS ARE IN MILLIMETERS.
2. DIMENSIONING AND TOLERANCING PER ASME Y14.5M-1994.
3. PACKAGE OUTLINE REFERENCE: EIAJ ED-7500A-1, SC-90.

4. MOLDED PLASTIC BODY LATERAL DIMENSIONS DO NOT INCLUDE MOLD FLASH, PROTRUSIONS OR GATE BURRS.

5. DWG NO. REF: HQ2SD07-SOD323F-018 REV A.

Notice

Specifications of the products displayed herein are subject to change without notice. TSC or anyone on its behalf assumes no responsibility or liability for any errors or inaccuracies.

Purchasers are solely responsible for the choice, selection, and use of TSC products and TSC assumes no liability for application assistance or the design of Purchasers' products.

Information contained herein is intended to provide a product description only. No license, express or implied, to any intellectual property rights is granted by this document. Except as provided in TSC's terms and conditions of sale for such products, TSC assumes no liability whatsoever, and disclaims any express or implied warranty, relating to sale and/or use of TSC products including liability or warranties relating to fitness for a particular purpose, merchantability, or infringement of any patent, copyright, or other intellectual property right.

The products shown herein are not designed for use in medical, life-saving, or life-sustaining applications. Customers using or selling these products for use in such applications do so at their own risk and agree to fully indemnify TSC for any damages resulting from such improper use or sale.

Mouser Electronics

Authorized Distributor

Click to View Pricing, Inventory, Delivery & Lifecycle Information:

[Taiwan Semiconductor:](#)

[BZT52C56S RRG](#) [BZT52C56S RR](#) [BZT52C56S R9G](#) [BZT52C56S R9](#)