

CUSTOMER PRINT

PART NUMBER: W3B80-8PG-5XX

- NOTES:  
 1. PARTS TO BE BULK PACKED.  
 2. CONTACTS ARE SUPPLIED LOOSE.  
 3. ALL DIMENSIONS ARE FOR REFERENCE ONLY EXCEPT WHERE NOTED WITH TOLERANCE.

ASSY P/N	COUPLING RING P/N	CABLE O.D.
W3B80-8PG-535	4282V4	.350-.400 IN. [8.9-10.2mm]
W3B80-8PG-535W	4482V4	.350-.400 IN. [8.9-10.2mm]

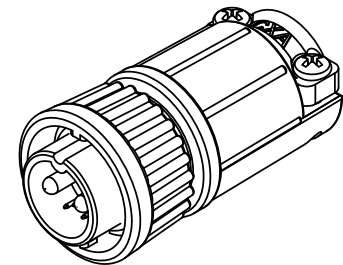

**STD COUPLING RING**  
P/N: W3B80-8PG-5XX

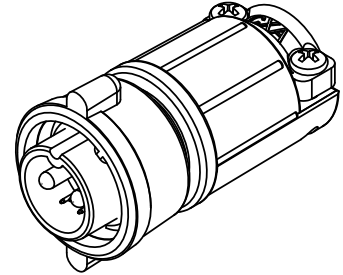

**WINGED COUPLING RING**  
P/N: W3B80-8PG-5XXW

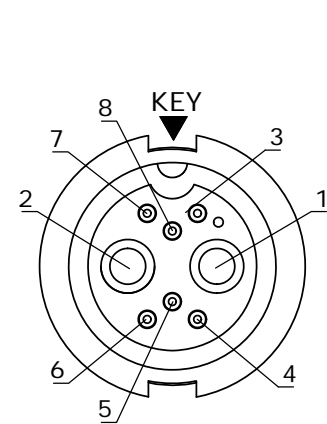

**FACE VIEW**

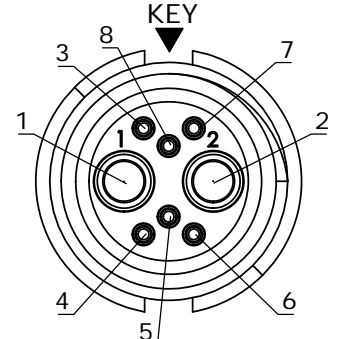

**WIRE VIEW**

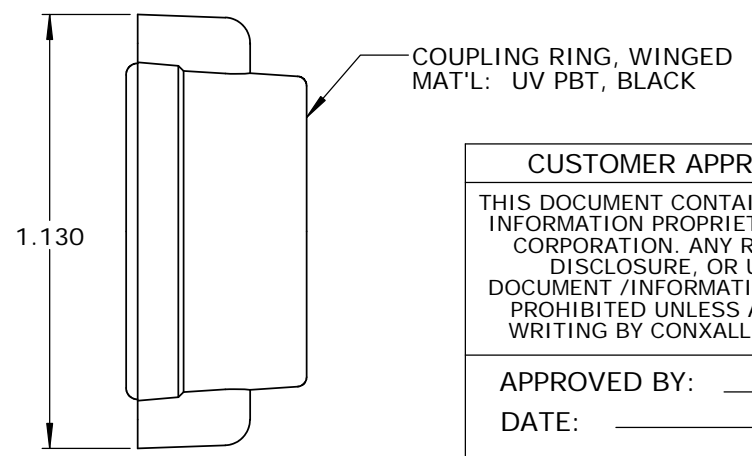
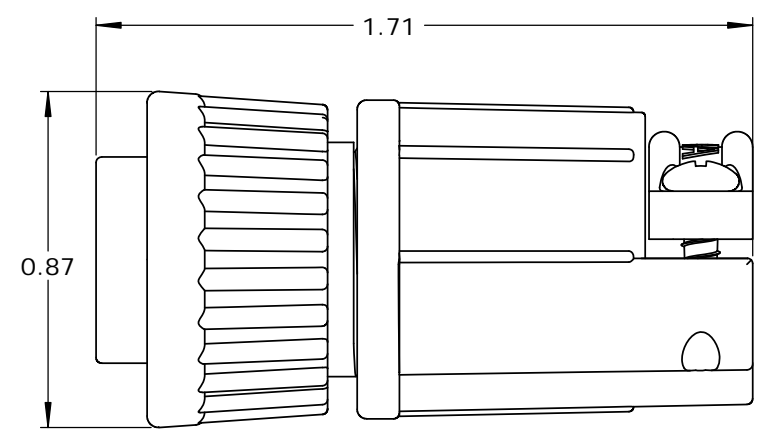
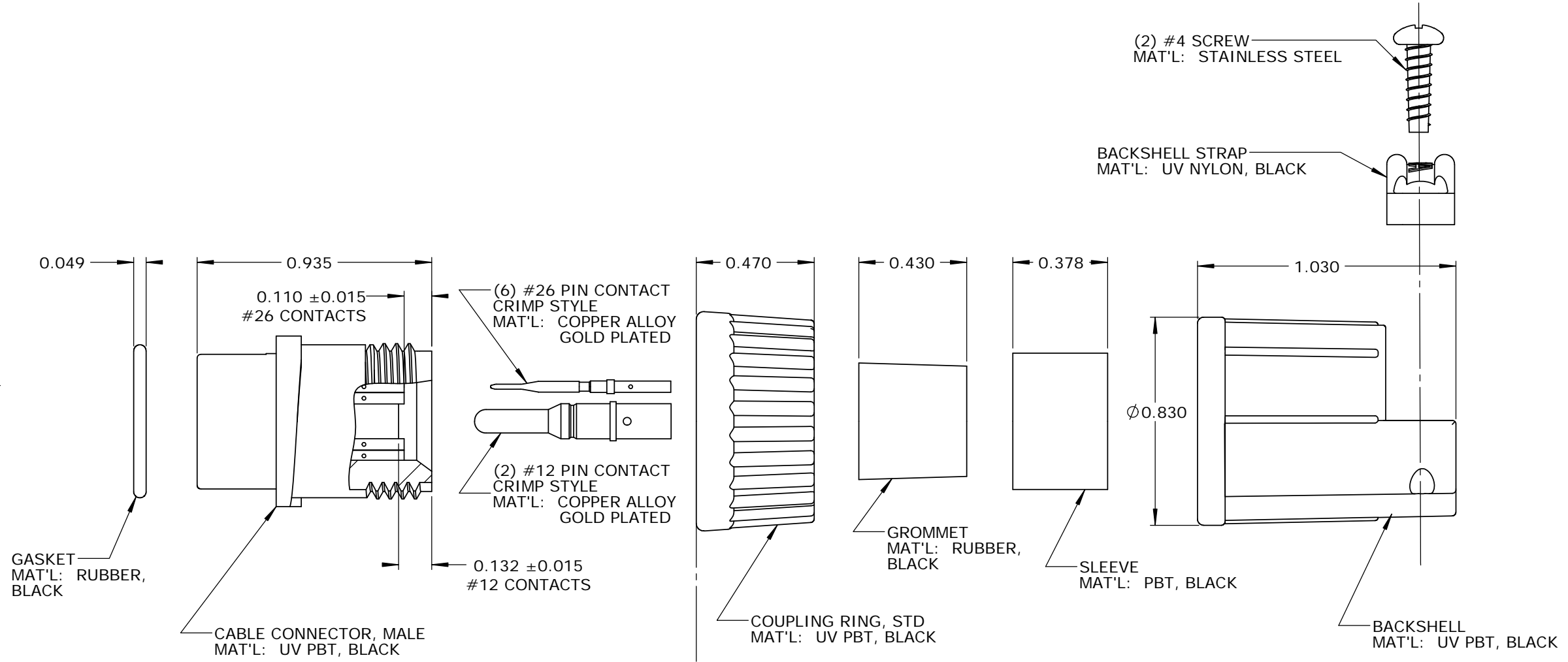

**CUSTOMER APPROVAL**

THIS DOCUMENT CONTAINS CONFIDENTIAL INFORMATION PROPRIETARY TO CONXALL CORPORATION. ANY REPRODUCTION, DISCLOSURE, OR USE OF THIS DOCUMENT /INFORMATION IS EXPRESSLY PROHIBITED UNLESS AUTHORIZED IN WRITING BY CONXALL CORPORATION.

APPROVED BY: \_\_\_\_\_

DATE: \_\_\_\_\_

**RoHS COMPLIANT**

A	AB	05-09-19	RELEASE PER DOR 14-6281TC
REV.	INIT.	DATE	DESCRIPTION
ALL INFORMATION ILLUSTRATED IS THE PROPERTY OF CONXALL CORPORATION. UNAUTHORIZED DUPLICATION OR DISTRIBUTION OF THIS DOCUMENT IS PROHIBITED.		ORIG. DRAWN BY: AB	DATE: 07-21-14
ALL UNITS ARE IN FEET, INCHES, FRACTION OF INCHES AND DECIMALS.		CHECKED BY:	<p>601 E. WILDWOOD VILLA PARK, IL 60181</p>
APPROVED BY:		TITLE: CABLE END CONNECTOR KIT (2)#12 + (6)#26 PIN CONTACTS, CRIMP MULTI-CON-X, WEATHER RESISTANT STANDARD PRODUCT	
SCALE: NTS	SIZE: B	SHEET: 1 OF 1	CUSTOMER: STANDARD PRODUCT
FILE: SAME AS P/N	DIRECTORY: SLW	PART NUMBER: W3B80-8PG-5XX(W)	REV: A

# Mouser Electronics

Authorized Distributor

Click to View Pricing, Inventory, Delivery & Lifecycle Information:

[Switchcraft:](#)

[W3B80-8PG-535](#)