

PART NUMBER	CONTACT PINS		HOUSING FINISH	INSULATOR COLOR
	QTY	FINISH		
QT3MZ	3	SILVER	NICKEL	GREEN
QT3MAUZ	3	GOLD	NICKEL	GREEN
QT3MBZ	3	SILVER	BLACK CHROME	BLACK
QT3MBAUZ	3	GOLD	BLACK CHROME	BLACK
QT4MZ	4	SILVER	NICKEL	GREEN
QT4MAUZ	4	GOLD	NICKEL	GREEN
QT4MBZ	4	SILVER	BLACK CHROME	BLACK
QT4MBAUZ	4	GOLD	BLACK CHROME	BLACK
QT5MZ	5	SILVER	NICKEL	GREEN
QT5MAUZ	5	GOLD	NICKEL	GREEN
QT5MBZ	5	SILVER	BLACK CHROME	BLACK
QT5MBAUZ	5	GOLD	BLACK CHROME	BLACK
QT6MZ	6	SILVER	NICKEL	GREEN
QT6MAUZ	6	GOLD	NICKEL	GREEN
QT6MBZ	6	SILVER	BLACK CHROME	BLACK
QT6MBAUZ	6	GOLD	BLACK CHROME	BLACK
QT7MZ	7	SILVER	NICKEL	GREEN
QT7MAUZ	7	GOLD	NICKEL	GREEN
QT7MBZ	7	SILVER	BLACK CHROME	BLACK
QT7MBAUZ	7	GOLD	BLACK CHROME	BLACK

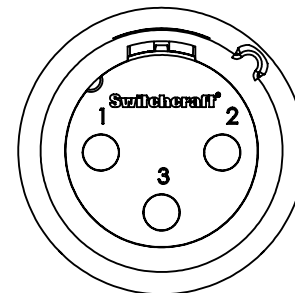

3 PIN

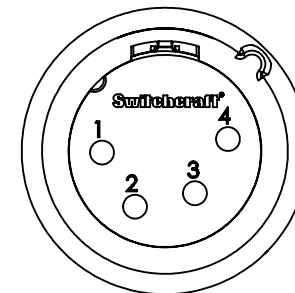

4 PIN

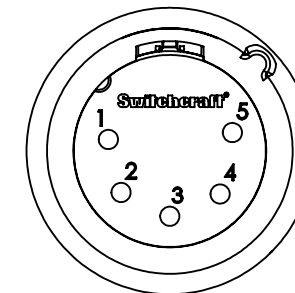

5 PIN

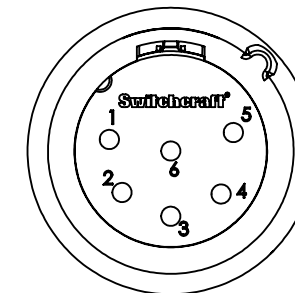

6 PIN

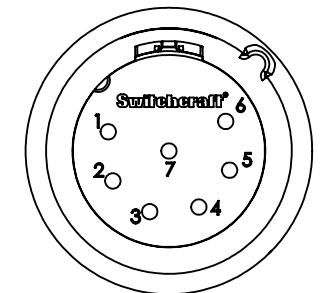

7 PIN

CONTACT PINS AS VIEWED FACING MALE CONNECTOR

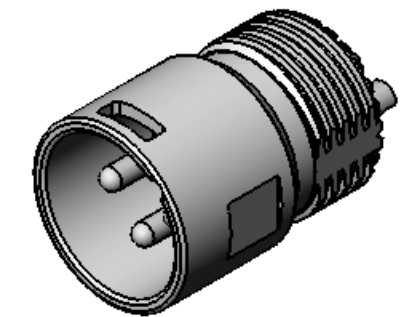
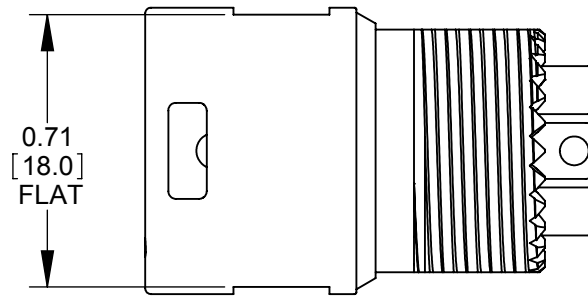

QT3MZ SHOWN

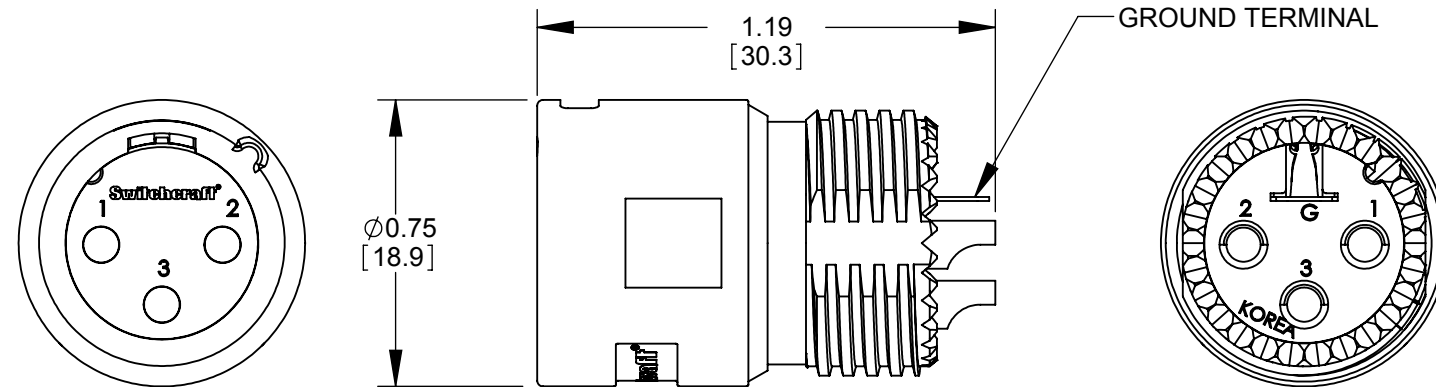

CUSTOMER DRAWING

NOTES:

- MATERIALS:
HOUSING - ZINC ALLOY
INSULATOR - THERMOPLASTIC
GROUND TERMINAL - SPECIAL COPPER ALLOY
CONTACT PINS - COPPER ALLOY
- THESE PRODUCTS ARE RoHS COMPLIANT.

REV	ECO NUMBER	DATE	BY	APVD
D	27081	01/25/13	BL	TJK
C	24940	12-1-04	RS	TJK
B	24552	10-10-03	JL	BRH
A	24446	8-11-03	JL	BRH
REVISIONS				

★ STAR SYMBOL DENOTES CRITICAL DIMENSION

UNLESS OTHERWISE SPECIFIED

- ALL DIMENSIONS IN INCHES
- TWO PLACE DECIMALS ±0.01
- THREE PLACE DECIMALS ±0.005
- ANGLES ±1°
- ALL DIA. CONCENTRIC WITHIN 0.005 T.I.R.
- FEATURES ON THE SAME CENTERLINE MUST BE ALIGNED WITHIN ±0.002
- REMOVE ALL BURRS

DO NOT SCALE DRAWING

THIS DRAWING DESCRIBES A DESIGN CONSIDERED PROPRIETARY IN NATURE, DEVELOPED AND MANUFACTURED BY SWITCHCRAFT INC. AND IS RELEASED ON A CONFIDENTIAL BASIS FOR IDENTIFICATION PURPOSES ONLY.

SIZE	WIDTH	MULT	LBS/M	TEMPER
FINISH		MATERIAL		
SPEC No.		SPEC No.		
FIRST USED ON AAA3MZ		SCALE 2:1		
DATE DRAWN	BY	CHKD	APVD	
3-10-03	BRH	BRH	BRH	
		8-11-03	8-11-03	
NAME				PART No.
MALE XLR INSERT SUB-ASSY, RoHS				QT_MZ SERIES
				REV D

Switchcraft®

SHEET 1 OF 1

Mouser Electronics

Authorized Distributor

Click to View Pricing, Inventory, Delivery & Lifecycle Information:

[Switchcraft:](#)

[QT3MZ](#)