

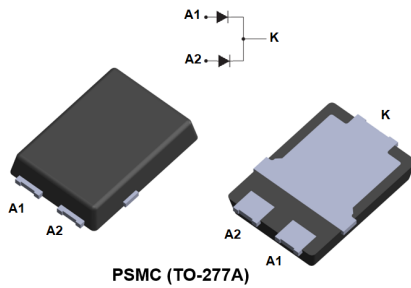

## Automotive 200 V, dual 3 A ultrafast rectifier



### Features

- AEC-Q101 qualified 
- PPAP capable
- 175 °C maximum operation junction temperature
- $V_{RRM}$  guaranteed from -40 °C to 175 °C
- High surge current capability
- ECOPACK2 compliant component

### Application

- Reverse polarity protection in E.C.U
- DC/DC converters
- Freewheeling diodes
- LED Lighting

### Description

The STTH602CSFY has been developed for applications requiring an optimized VF and reverse recovery characteristics.

These characteristics make it ideal for use in secondary rectification functions, such as DC/DC converters or lighting applications.

Product status link	
<a href="#">STTH602CSFY</a>	
Product summary	
Symbol	Value
$I_{F(AV)}$	2 X 3 A
$V_{RRM}$	200 V
$t_{rr(max)}$	24 ns
$T_j(max.)$	175 °C
$V_F(typ.)$	0.80 V

# 1 Characteristics

**Table 1. Absolute ratings (limiting values per diode at 25 °C, unless otherwise specified)**

Symbol	Parameter		Value	Unit	
$V_{RRM}$	Repetitive peak reverse voltage ( $T_j = -40\text{ °C}$ to $+175\text{ °C}$ )		200	V	
$I_{F(AV)}$	Average forward current, $\delta = 0.5$	Per diode	$T_c = 155\text{ °C}$	3	A
		Per device	$T_c = 155\text{ °C}$	6	
$I_{FSM}$	Surge non repetitive forward current		$t_p = 10\text{ ms}$ sinusoidal	55	A
$T_{stg}$	Storage temperature range		-65 to +175	°C	
$T_j$	Operating junction temperature range		-40 to +175	°C	

**Table 2. Thermal resistance parameters**

Symbol	Parameter		Typ.	Unit
$R_{th(j-c)}$	Junction to case	Total	2.14	°C/W

For more information, please refer to the following application note:

- AN5088: Rectifiers thermal management, handling and mounting recommendations

**Table 3. Static electrical characteristics (per diode)**

Symbol	Parameter	Test conditions		Min.	Typ.	Max.	Unit
$I_R^{(1)}$	Reverse leakage current	$T_j = 25\text{ °C}$	$V_R = V_{RRM}$	-		4	$\mu\text{A}$
		$T_j = 125\text{ °C}$		-	3	30	
$V_F^{(2)}$	Forward voltage drop	$T_j = 25\text{ °C}$	$I_F = 3\text{ A}$	-	0.92	1.06	V
		$T_j = 125\text{ °C}$		-	0.80	0.92	
		$T_j = 25\text{ °C}$	$I_F = 6\text{ A}$	-	1.02	1.17	
		$T_j = 125\text{ °C}$		-	0.90	1.04	

1. Pulse test:  $t_p = 5\text{ ms}$ ,  $\delta < 2\%$

2. Pulse test:  $t_p = 380\text{ }\mu\text{s}$ ,  $\delta < 2\%$

To evaluate the conduction losses, use the following equation:

$$P = 0.80 \times I_{F(AV)} + 0.040 \times I_F^2_{(RMS)}$$

For more information, please refer to the following application notes related to the power losses:

- AN604: Calculation of conduction losses in a power rectifier
- AN4021: Calculation of reverse losses in a power diode

**Table 4. Dynamic characteristics per diode at  $T_j = 25^\circ\text{C}$ , unless otherwise specified**

Symbol	Parameter	Test conditions		Min.	Typ.	Max.	Unit
$t_{rr}$	Reverse recovery time	$T_j = 25^\circ\text{C}$	$I_F = 1\text{ A}, dI_F/dt = -50\text{ A}/\mu\text{s}, V_R = 30\text{ V}$	-	24	31	ns
			$I_F = 1\text{ A}, dI_F/dt = -100\text{ A}/\mu\text{s}, V_R = 30\text{ V}$	-	19	24	
$I_{RM}$	Reverse recovery current	$T_j = 125^\circ\text{C}$	$I_F = 3\text{ A}, dI_F/dt = -200\text{ A}/\mu\text{s}, V_R = 160\text{ V}$	-	4.8		A

## 1.1 Characteristics (curves)

**Figure 1. Conduction losses versus average forward current (per diode)**

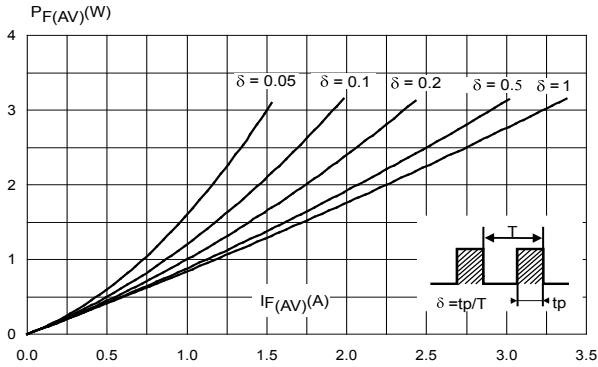

**Figure 2. Forward voltage drop versus forward current (typical values, per diode)**

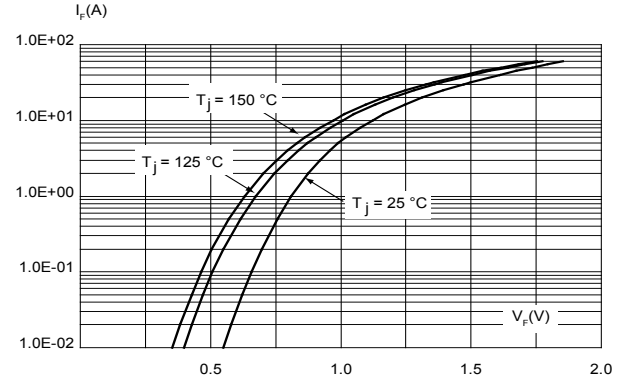

**Figure 3. Forward voltage drop versus forward current (maximum values, per diode)**

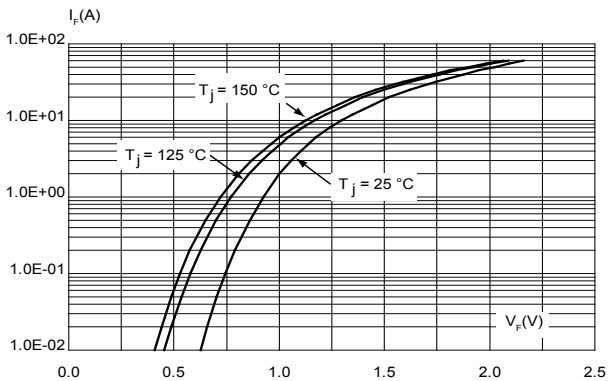

**Figure 4. Relative variation of thermal impedance junction to case total versus pulse duration**

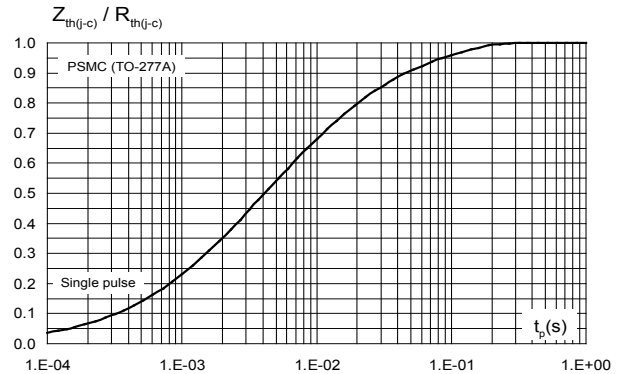

**Figure 5. Peak reverse recovery current versus dIF/dt (typical values, per diode)**

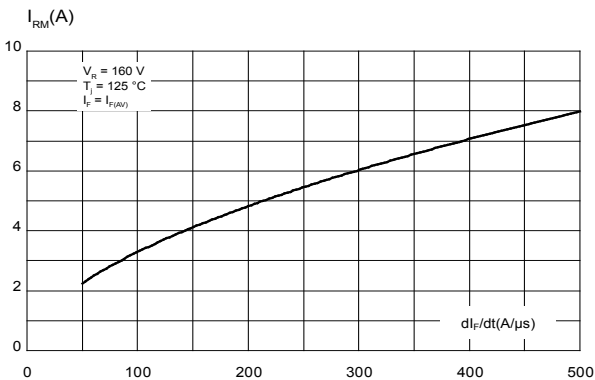

**Figure 6. Reverse recovery time versus dIF/dt (typical values, per diode)**

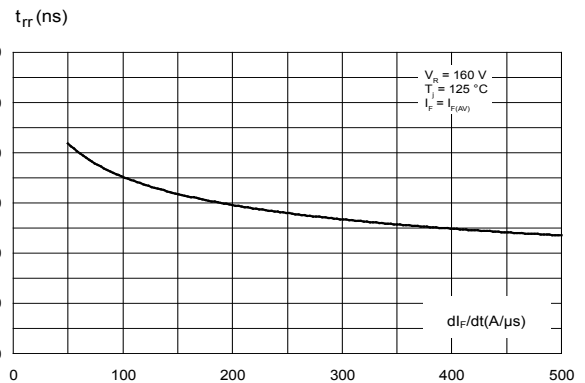

**Figure 7. Reverse recovery charges versus  $di_F/dt$  (typical values, per diode)**

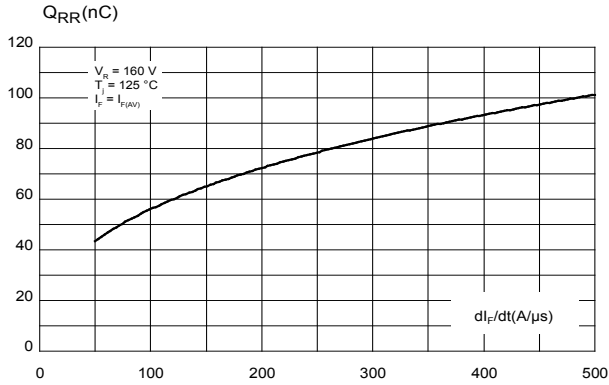

**Figure 8. Reverse recovery softness versus  $di_F/dt$  (typical values, per diode)**

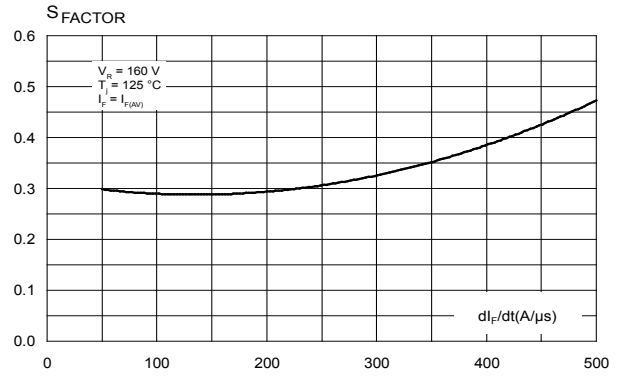

**Figure 9. Relative variations of dynamic parameters versus junction temperature**

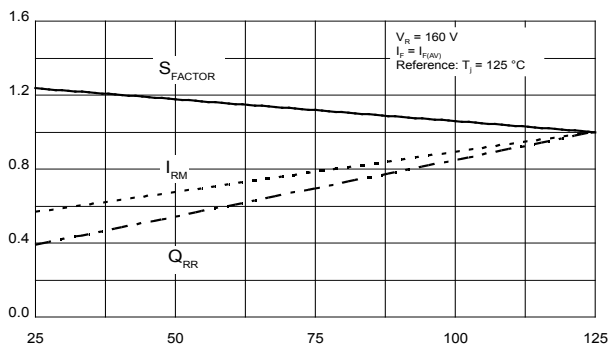

**Figure 10. Junction capacitance versus reverse voltage applied (typical values, per diode)**

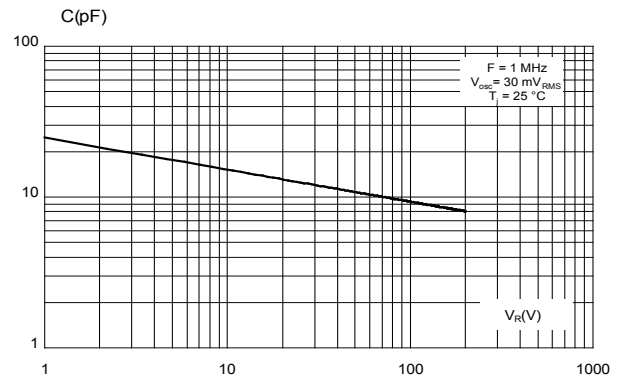

**Figure 11. Thermal resistance junction to ambient versus copper surface under tab (typical values, epoxy printed board FR4,  $e_{Cu} = 70 \mu\text{m}$ ) (PSMC (TO-277A))**

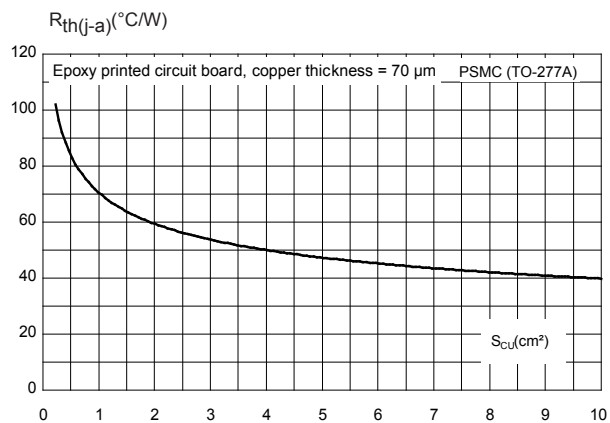

## 2 Package information

In order to meet environmental requirements, ST offers these devices in different grades of **ECOPACK** packages, depending on their level of environmental compliance. ECOPACK specifications, grade definitions and product status are available at: [www.st.com](http://www.st.com). ECOPACK is an ST trademark.

### 2.1 PSMC (TO-277A) package information

- Epoxy meets UL94,V0
- Cooling method : by conduction (C)

Figure 12. PSMC (TO-277A) package outline

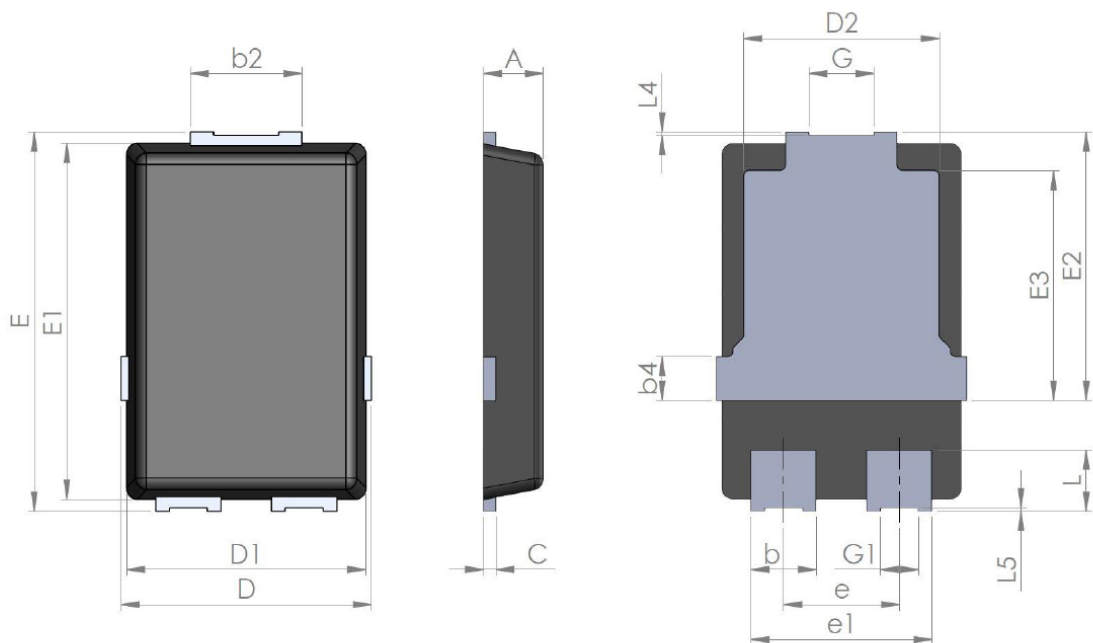

**Table 5. PSMC (TO-277A) package mechanical data**

Ref.	Dimensions					
	Millimeters			Inches (for reference only)		
	Min.	Typ.	Max.	Min.	Typ.	Max.
A	1.00	1.10	1.20	0.039	0.043	0.047
b	1.05	1.20	1.35	0.041	0.047	0.053
b2	1.90	2.05	2.20	0.075	0.081	0.087
b4		0.75			0.029	
C	0.15	0.23	0.40	0.006	0.009	0.016
D	4.45	4.60	4.75	0.175	0.181	0.187
D1	4.25	4.40	4.45	0.167	0.173	0.175
D2	3.40	3.60	3.70	0.134	0.142	0.146
E	6.35	6.50	6.65	0.250	0.256	0.262
E1	6.05	6.10	6.15	0.238	0.240	0.242
E2	4.50	4.60	4.70	0.177	0.181	0.185
E3		3.94			1.55	
e		2.13			0.084	
e1		3.33			0.131	
G		1.20			0.047	
G1		0.70			0.027	
L	0.90	1.05	1.24	0.035	0.041	0.049
L4	0.02			0.0008		
L5	0.02			0.0008		

**Figure 13. PSMC (TO-277A) package footprint in mm (in inches)**

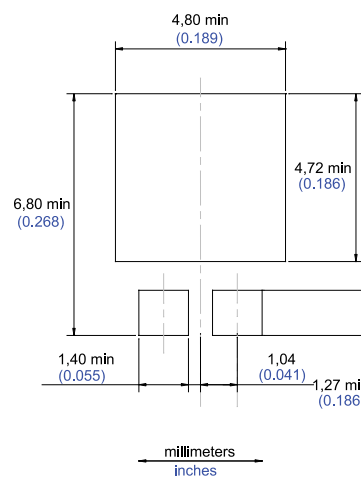

*Note:* For package and tape orientation, reel and inner box dimensions and tape outline please check [TN1173](#)

### 3 Ordering information

**Table 6. Ordering information**

Order code	Marking	Package	Weight	Base qty.	Delivery mode
STTH602CSFY	T602CY	PSMC (TO-277A)	90 mg	6000	Tape and Reel



## Revision history

**Table 7. Document revision history**

Date	Version	Changes
06-Nov-2020	1	Initial release.

**IMPORTANT NOTICE – PLEASE READ CAREFULLY**

STMicroelectronics NV and its subsidiaries (“ST”) reserve the right to make changes, corrections, enhancements, modifications, and improvements to ST products and/or to this document at any time without notice. Purchasers should obtain the latest relevant information on ST products before placing orders. ST products are sold pursuant to ST’s terms and conditions of sale in place at the time of order acknowledgement.

Purchasers are solely responsible for the choice, selection, and use of ST products and ST assumes no liability for application assistance or the design of Purchasers’ products.

No license, express or implied, to any intellectual property right is granted by ST herein.

Resale of ST products with provisions different from the information set forth herein shall void any warranty granted by ST for such product.

ST and the ST logo are trademarks of ST. For additional information about ST trademarks, please refer to [www.st.com/trademarks](http://www.st.com/trademarks). All other product or service names are the property of their respective owners.

Information in this document supersedes and replaces information previously supplied in any prior versions of this document.

© 2020 STMicroelectronics – All rights reserved

# Mouser Electronics

Authorized Distributor

Click to View Pricing, Inventory, Delivery & Lifecycle Information:

[STMicroelectronics:](#)

[STTH602CSFY](#)