

20 A 600 V high temperature SCR thyristors in insulated TO-220

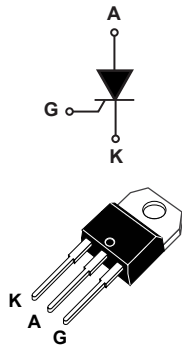

TO-220AB insulated

Features

- High junction temperature: $T_j \text{ max.} = 150 \text{ }^\circ\text{C}$
- High static immunity $dV/dt = 750 \text{ V}/\mu\text{s}$ up to $150 \text{ }^\circ\text{C}$
- Peak off-state voltage $V_{\text{DRM}}/V_{\text{RRM}} = 600 \text{ V}$
- High turn-on current rise $dI/dt = 100 \text{ A}/\mu\text{s}$
- Insulated package TO-220AB:
 - Insulated voltage: $2500 \text{ V}_{\text{RMS}}$
 - Complies with UL 1557 (File ref : E81734)
- ECOPACK2 compliant
- Halogen-free molding, lead-free plating

Applications

- General purpose AC line load switching
- Motor control circuits and starters
- Inrush current limiting circuits
- Heating resistor control, solid state relays

Description

Thanks to its operating junction temperature up to 150°C , the TN2015H-6I offers high thermal performance operation up to 20 A rms.

Its trade-off noise immunity ($dV/dt = 750 \text{ V}/\mu\text{s}$) versus its gate triggering current ($I_{\text{GT}} = 15 \text{ mA}$) and its turn-on current rise ($dI/dt = 100 \text{ A}/\mu\text{s}$) allows to design robust and compact control circuit for voltage regulator in motorbikes and industrial drives, overvoltage crowbar protection, motor control circuits in power tools and kitchen appliances and inrush current limiting circuits.

Product status	
TN2015H-6I	
Product summary	
Order code	TN2015H-6I
Package	TO-220AB Ins.
$I_{\text{T(RMS)}}$	20 A
$V_{\text{DRM}}/V_{\text{RRM}}$	600 V
$T_j \text{ max.}$	$150 \text{ }^\circ\text{C}$

1 Characteristics

Table 1. Absolute maximum ratings (limiting values), $T_j = 25\text{ °C}$ unless otherwise specified

Symbol	Parameter	Value	Unit
$I_{T(RMS)}$	RMS on-state current (180 ° conduction angle)	$T_c = 113\text{ °C}$ 20	A
$I_{T(AV)}$	Average on-state current (180 ° conduction angle)	$T_c = 112\text{ °C}$ 13	A
		$T_c = 130\text{ °C}$ 8	
		$T_c = 139\text{ °C}$ 5	
I_{TSM}	Non repetitive surge peak on-state current (T_j initial = 25 °C)	$t_p = 8.3\text{ ms}$ 197	A
		$t_p = 10\text{ ms}$ 180	
I^2t	I^2t value for fusing, (T_j initial = 25 °C)	$t_p = 10\text{ ms}$ 162	A^2s
di/dt	$I_G = 2 \times I_{GT}$, $tr \leq 100\text{ ns}$ Critical rate of rise of on-state current	$f = 60\text{ Hz}$ 100	$A/\mu s$
V_{DRM}/V_{RRM}	Repetitive peak off-state voltage	600	V
V_{DSM}/V_{RSM}	Non Repetitive peak off-state voltage	$t_p = 10\text{ ms}$ $V_{DRM}/V_{RRM} + 100\text{ V}$	V
I_{GM}	Peak gate current	$t_p = 20\text{ }\mu s$ $T_j = 150\text{ °C}$ 4	A
$P_{G(AV)}$	Average gate power dissipation	$T_j = 150\text{ °C}$ 1	W
V_{RGM}	Maximum peak reverse voltage	5	V
T_{stg}	Storage junction temperature range	-40 to +150	°C
T_j	Maximum operating junction temperature	-40 to +150	°C
T_l	Maximum lead temperature soldering during 10 s	260	°C
V_{iso}	Insulation rms voltage, 1 minute	2500	V

Table 2. Electrical characteristics ($T_j = 25\text{ °C}$ unless otherwise specified)

Symbol	Test conditions	Value	Unit
I_{GT}	$V_D = 12\text{ V}$, $R_L = 33\text{ }\Omega$	Typ. 6	mA
		Max. 15	
V_{GT}		Max. 1.3	V
V_{GD}	$V_D = V_{DRM}$, $R_L = 3.3\text{ k}\Omega$	$T_j = 150\text{ °C}$ Min. 0.1	V
I_H	$I_T = 500\text{ mA}$, gate open	Max. 50	mA
I_L	$I_G = 1.2 \times I_{GT}$	Max. 60	mA
dV/dt	$V_D = 402\text{ V}$, gate open	$T_j = 150\text{ °C}$ Min. 750	$V/\mu s$
t_{gt}	$I_T = 40\text{ A}$, $V_D = 402\text{ V}$, $I_G = 20\text{ mA}$, $(dI_G/dt)_{max} = 0.2\text{ A}/\mu s$	Typ. 1.9	μs
t_q	$I_T = 20\text{ A}$, $V_D = 402\text{ V}$, $(dI_G/dt)_{max} = 30\text{ A}/\mu s$, $V_R = 25\text{ V}$, $dV_D/dt = 40\text{ V}/\mu s$	$T_j = 150\text{ °C}$ Typ. 70	μs

Table 3. Static characteristics

Symbol	Test conditions			Value	Unit
V_{TM}	$I_{TM} = 40\text{ A}$, $t_p = 380\ \mu\text{s}$	$T_j = 25\text{ °C}$	Max.	1.60	V
V_{TO}	Threshold voltage	$T_j = 150\text{ °C}$	Max.	0.82	
R_D	Dynamic resistance	$T_j = 150\text{ °C}$	Max.	17.5	mΩ
I_{DRM} , I_{RRM}	$V_D = V_{DRM}$; $V_R = V_{RRM}$	$T_j = 25\text{ °C}$	Max.	5	μA
		$T_j = 150\text{ °C}$		2	mA

Table 4. Thermal parameters

Symbol	Parameter		Value	Unit
$R_{th(j-c)}$	Junction to case (DC)	Max.	2.1	°C/W
$R_{th(j-a)}$	Junction to ambient (DC)	Typ.	60	

1.1 Characteristics curves

Figure 1. Maximum power dissipation versus average on-state current

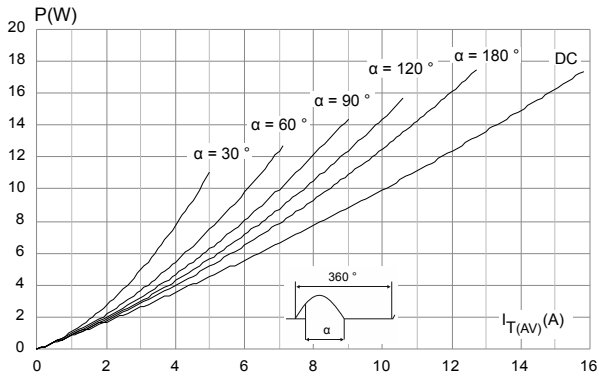

Figure 2. Average and DC on-state current versus case temperature

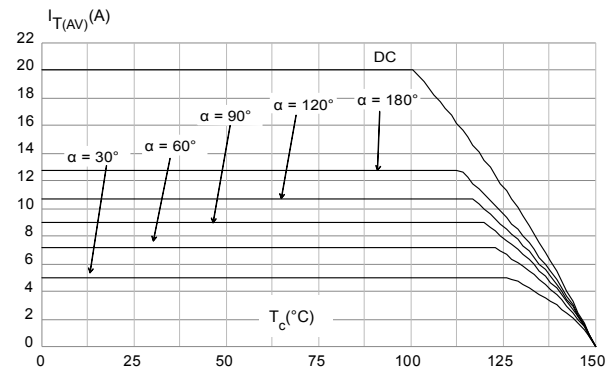

Figure 3. Average and D.C. on state current versus ambient temperature

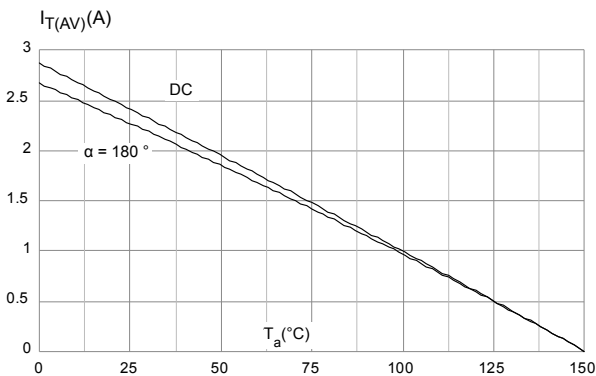

Figure 4. Relative variation of thermal impedance junction to case and junction to ambient versus pulse duration

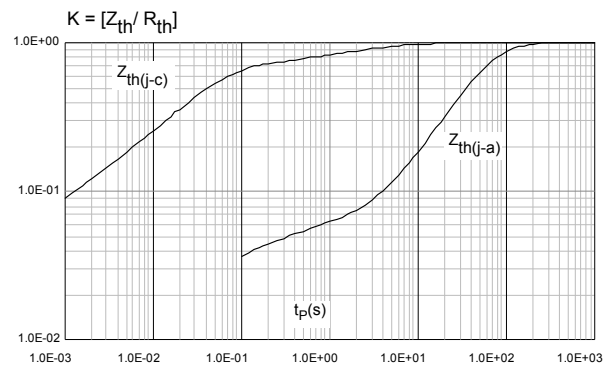

Figure 5. Relative variation of gate triggering current and gate voltage versus junction temperature (typical values)

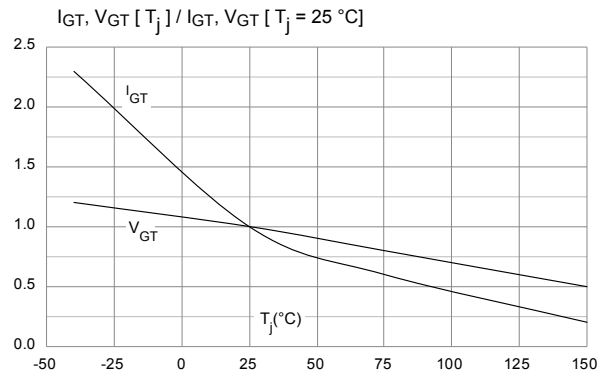

Figure 6. Relative variation of holding and latching current versus junction temperature (typical values)

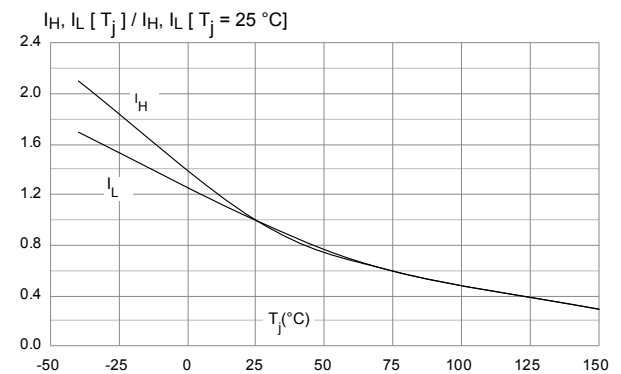

Figure 7. Relative variation of static dV/dt immunity versus junction temperature

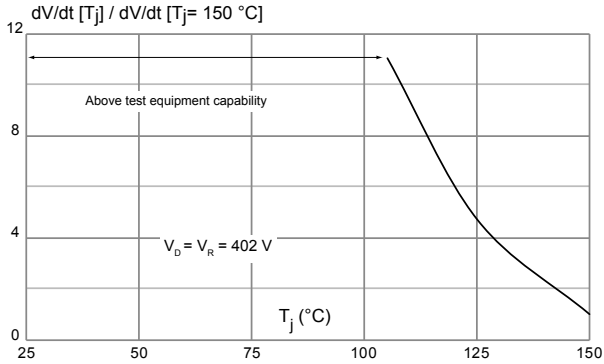

Figure 8. Surge peak on-state current versus number of cycles

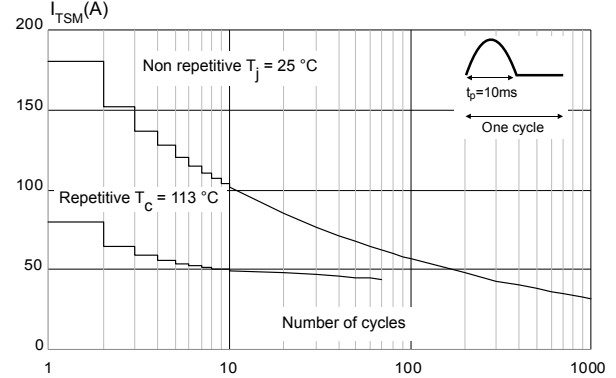

Figure 9. Non repetitive surge peak on-state current for a sinusoidal pulse with width $t_p < 10$ ms

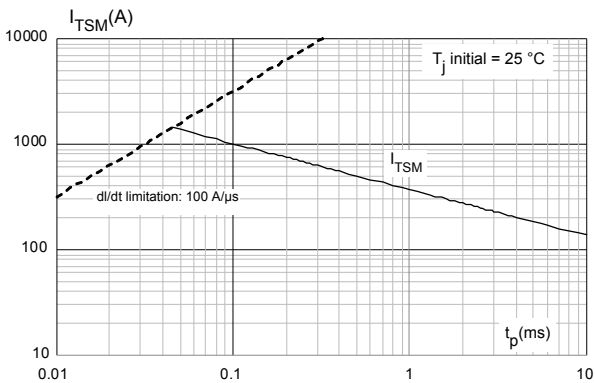

Figure 10. On-state characteristics (maximum values)

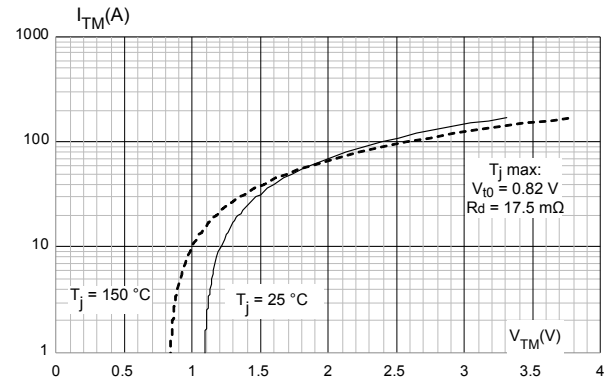
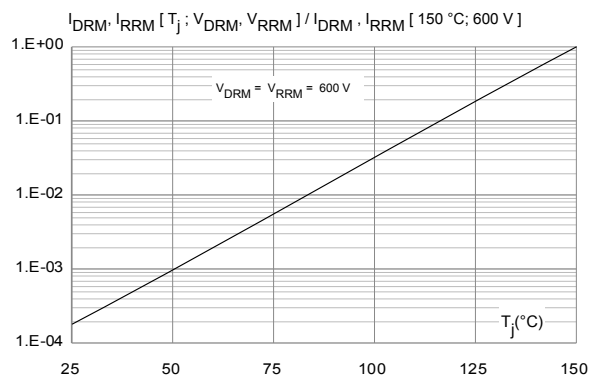

Figure 11. Relative variation of leakage current versus junction



2 Package information

In order to meet environmental requirements, ST offers these devices in different grades of **ECOPACK** packages, depending on their level of environmental compliance. ECOPACK specifications, grade definitions and product status are available at: www.st.com. ECOPACK is an ST trademark.

2.1 TO-220AB insulated package information

- Molding compound resin is halogen-free and meets flammability standard UL94 level 0
- Lead-free package leads finishing
- **ECOPACK2** compliant
- Recommended torque: 0.4 to 0.6 N.m

Figure 12. TO-220AB insulated package outline

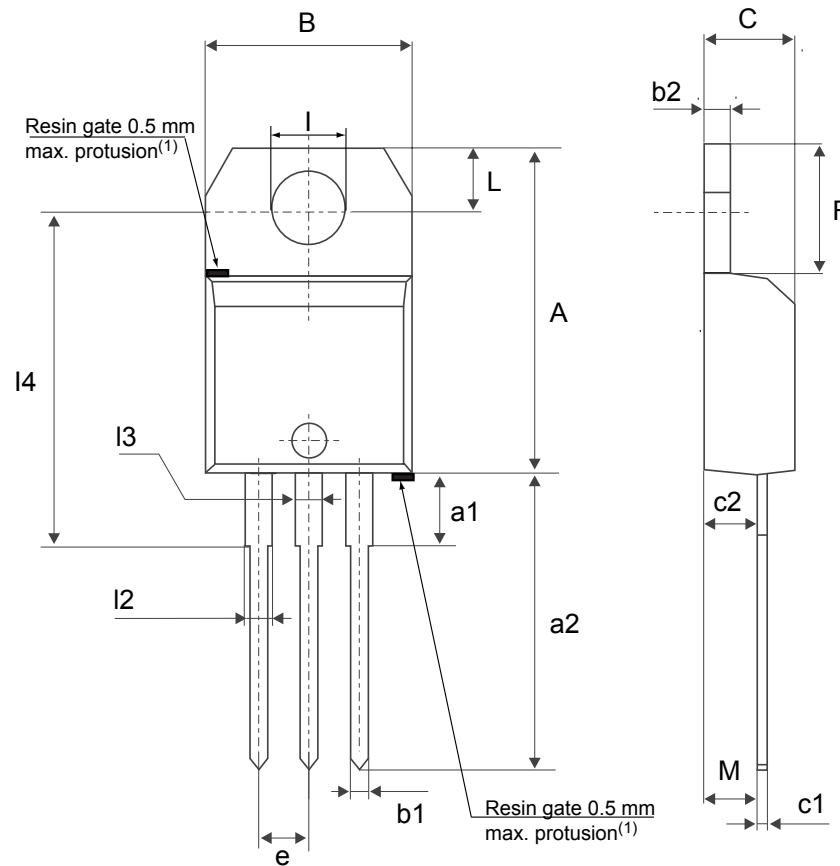

(1) Resin gate position accepted in one of the two positions or in the symmetrical opposites.

Table 5. TO-220AB insulated package mechanical data

Ref.	Dimensions					
	Millimeters			Inches ⁽¹⁾		
	Min.	Typ.	Max.	Min.	Typ.	Max.
A	15.20		15.90	0.5984		0.6260
a1		3.75			0.1476	
a2	13.00		14.00	0.5118		0.5512
B	10.00		10.40	0.3937		0.4094
b1	0.61		0.88	0.0240		0.0346
b2	1.23		1.32	0.0484		0.0520
C	4.40		4.60	0.1732		0.1811
c1	0.49		0.70	0.0193		0.0276
c2	2.40		2.72	0.0945		0.1071
e	2.40		2.70	0.0945		0.1063
F	6.20		6.60	0.2441		0.2598
I	3.73		3.88	0.1469		0.1528
L	2.65		2.95	0.1043		0.1161
I2	1.14		1.70	0.0449		0.0669
I3	1.14		1.70	0.0449		0.0669
I4	15.80	16.40	16.80	0.6220	0.6457	0.6614
M		2.6			0.1024	

1. Inch dimensions are for reference only.

3 Ordering information

Figure 13. Ordering information scheme

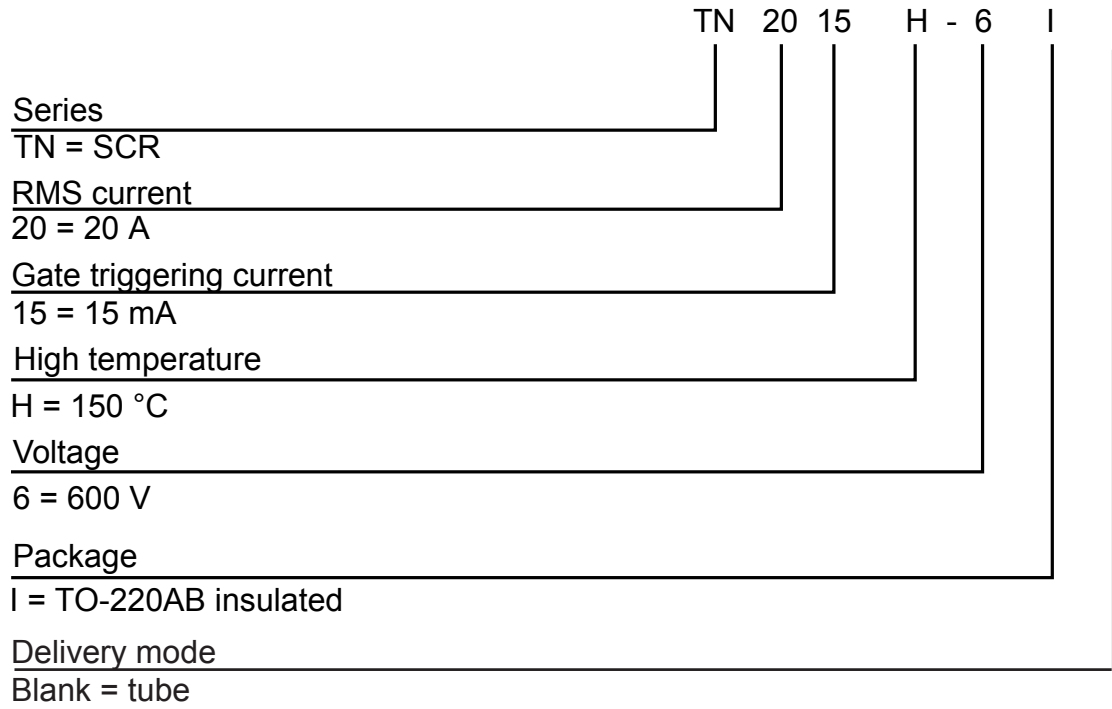

Table 6. Ordering information

Order code	Marking	Package	Weight	Base qty.	Delivery mode
TN2015H-6I	TN2015H6I	TO-220AB Ins.	2.3 g	50	Tube

Revision history

Table 7. Document revision history

Date	Revision	Changes
16-Dec-2019	1	Initial release.

IMPORTANT NOTICE – PLEASE READ CAREFULLY

STMicroelectronics NV and its subsidiaries (“ST”) reserve the right to make changes, corrections, enhancements, modifications, and improvements to ST products and/or to this document at any time without notice. Purchasers should obtain the latest relevant information on ST products before placing orders. ST products are sold pursuant to ST’s terms and conditions of sale in place at the time of order acknowledgement.

Purchasers are solely responsible for the choice, selection, and use of ST products and ST assumes no liability for application assistance or the design of Purchasers’ products.

No license, express or implied, to any intellectual property right is granted by ST herein.

Resale of ST products with provisions different from the information set forth herein shall void any warranty granted by ST for such product.

ST and the ST logo are trademarks of ST. For additional information about ST trademarks, please refer to www.st.com/trademarks. All other product or service names are the property of their respective owners.

Information in this document supersedes and replaces information previously supplied in any prior versions of this document.

© 2019 STMicroelectronics – All rights reserved

Mouser Electronics

Authorized Distributor

Click to View Pricing, Inventory, Delivery & Lifecycle Information:

[STMicroelectronics:](#)

[TN2015H-6I](#)