

N-channel 600 V, 165 mΩ typ., 18 A, MDmesh DM6 Power MOSFET in a TO-220 package

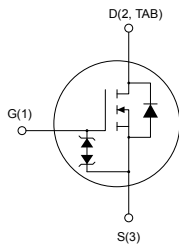

Features

Order code	V _{DS}	R _{DS(on)} max.	I _D
STP26N60DM6	600 V	195 mΩ	18 A

- Fast-recovery body diode
- Lower R_{DS(on)} per area vs previous generation
- Low gate charge, input capacitance and resistance
- 100% avalanche tested
- Extremely high dv/dt ruggedness
- Zener-protected

Applications

- Switching applications

Description

This high-voltage N-channel Power MOSFET is part of the MDmesh DM6 fast-recovery diode series. Compared with the previous MDmesh fast generation, DM6 combines very low recovery charge (Q_{rr}), recovery time (t_{rr}) and excellent improvement in R_{DS(on)} per area with one of the most effective switching behaviors available in the market for the most demanding high-efficiency bridge topologies and ZVS phase-shift converters.



Product status link

[STP26N60DM6](#)

Product summary

Order code	STP26N60DM6
Marking	26N60DM6
Package	TO-220
Packing	Tube

1 Electrical ratings

Table 1. Absolute maximum ratings

Symbol	Parameter	Value	Unit
V_{GS}	Gate-source voltage	± 25	V
I_D	Drain current (continuous) at $T_C = 25\text{ }^\circ\text{C}$	18	A
	Drain current (continuous) at $T_C = 100\text{ }^\circ\text{C}$	11	A
$I_{DM}^{(1)}$	Drain current (pulsed)	60	A
P_{TOT}	Total power dissipation at $T_C = 25\text{ }^\circ\text{C}$	130	W
$dv/dt^{(2)}$	Peak diode recovery voltage slope	100	V/ns
$di/dt^{(2)}$	Peak diode recovery current slope	1000	A/ μs
$dv/dt^{(3)}$	MOSFET dv/dt ruggedness	100	V/ns
T_{stg}	Storage temperature range	-55 to 150	$^\circ\text{C}$
T_j	Operating junction temperature range		

1. Pulse width is limited by safe operating area.
2. $I_{SD} \leq 18\text{ A}$, V_{DS} (peak) $< V_{(BR)DSS}$, $V_{DD} = 400\text{ V}$.
3. $V_{DS} \leq 480\text{ V}$

Table 2. Thermal data

Symbol	Parameter	Value	Unit
$R_{thj-case}$	Thermal resistance junction-case	0.96	$^\circ\text{C/W}$
$R_{thj-amb}$	Thermal resistance junction-ambient	62.5	$^\circ\text{C/W}$

Table 3. Avalanche characteristics

Symbol	Parameter	Value	Unit
I_{AR}	Avalanche current, repetitive or not repetitive (pulse width limited by T_{jmax})	4	A
E_{AS}	Single pulse avalanche energy (starting $T_j = 25\text{ }^\circ\text{C}$, $I_D = I_{AR}$, $V_{DD} = 50\text{ V}$)	360	mJ

2 Electrical characteristics

$T_C = 25\text{ °C}$ unless otherwise specified

Table 4. On/off states

Symbol	Parameter	Test conditions	Min.	Typ.	Max.	Unit
$V_{(BR)DSS}$	Drain-source breakdown voltage	$V_{GS} = 0\text{ V}, I_D = 1\text{ mA}$	600			V
I_{DSS}	Zero gate voltage drain current	$V_{GS} = 0\text{ V}, V_{DS} = 600\text{ V}$			1	μA
		$V_{GS} = 0\text{ V}, V_{DS} = 600\text{ V}, T_C = 125\text{ °C}^{(1)}$			100	μA
I_{GSS}	Gate-body leakage current	$V_{DS} = 0\text{ V}, V_{GS} = \pm 25\text{ V}$			± 5	μA
$V_{GS(th)}$	Gate threshold voltage	$V_{DS} = V_{GS}, I_D = 250\text{ }\mu\text{A}$	3.25	4	4.75	V
$R_{DS(on)}$	Static drain-source on-resistance	$V_{GS} = 10\text{ V}, I_D = 9\text{ A}$		165	195	m Ω

1. Defined by design, not subject to production test.

Table 5. Dynamic

Symbol	Parameter	Test conditions	Min.	Typ.	Max.	Unit
C_{iss}	Input capacitance	$V_{DS} = 100\text{ V}, f = 1\text{ MHz}, V_{GS} = 0\text{ V}$	-	940	-	pF
C_{oss}	Output capacitance		-	75	-	pF
C_{riss}	Reverse transfer capacitance		-	4	-	pF
$C_{oss\text{ eq.}}^{(1)}$	Equivalent output capacitance	$V_{DS} = 0\text{ to }480\text{ V}, V_{GS} = 0\text{ V}$	-	157	-	pF
R_G	Intrinsic gate resistance	$f = 1\text{ MHz}, I_D = 0\text{ A}$	-	4.8	-	Ω
Q_g	Total gate charge	$V_{DD} = 480\text{ V}, I_D = 18\text{ A}, V_{GS} = 0\text{ to }10\text{ V}$ (see Figure 14. Test circuit for gate charge behavior)	-	24	-	nC
Q_{gs}	Gate-source charge		-	6	-	nC
Q_{gd}	Gate-drain charge		-	11.5	-	nC

1. $C_{oss\text{ eq.}}$ is defined as a constant equivalent capacitance giving the same charging time as C_{oss} when V_{DS} increases from 0 to 80% V_{DSS} .

Table 6. Switching times

Symbol	Parameter	Test conditions	Min.	Typ.	Max.	Unit
$t_{d(on)}$	Turn-on delay time	$V_{DD} = 300\text{ V}, I_D = 9\text{ A}, R_G = 4.7\text{ }\Omega, V_{GS} = 10\text{ V}$	-	13	-	ns
t_r	Rise time		-	11	-	ns
$t_{d(off)}$	Turn-off delay time	(see Figure 13. Test circuit for resistive load switching times and Figure 18. Switching time waveform)	-	39	-	ns
t_f	Fall time		-	8	-	ns

Table 7. Source drain diode

Symbol	Parameter	Test conditions	Min.	Typ.	Max.	Unit
I_{SD}	Source-drain current		-		18	A
$I_{SDM}^{(1)}$	Source-drain current (pulsed)		-		60	A
$V_{SD}^{(2)}$	Forward on voltage	$V_{GS} = 0\text{ V}$, $I_{SD} = 18\text{ A}$	-		1.6	V
t_{rr}	Reverse recovery time	$I_{SD} = 18\text{ A}$, $di/dt = 100\text{ A}/\mu\text{s}$, $V_{DD} = 60\text{ V}$	-	100		ns
Q_{rr}	Reverse recovery charge		-	0.35		μC
I_{RRM}	Reverse recovery current	(see Figure 15. Test circuit for inductive load switching and diode recovery times)	-	7		A
t_{rr}	Reverse recovery time	$I_{SD} = 18\text{ A}$, $di/dt = 100\text{ A}/\mu\text{s}$, $V_{DD} = 60\text{ V}$, $T_j = 150\text{ }^\circ\text{C}$	-	170		ns
Q_{rr}	Reverse recovery charge		-	1.02		μC
I_{RRM}	Reverse recovery current		(see Figure 15. Test circuit for inductive load switching and diode recovery times)	-	12	

1. Pulse width is limited by safe operating area.
2. Pulsed: pulse duration = 300 μs , duty cycle 1.5 %.

2.1 Electrical characteristics (curves)

Figure 1. Safe operating area

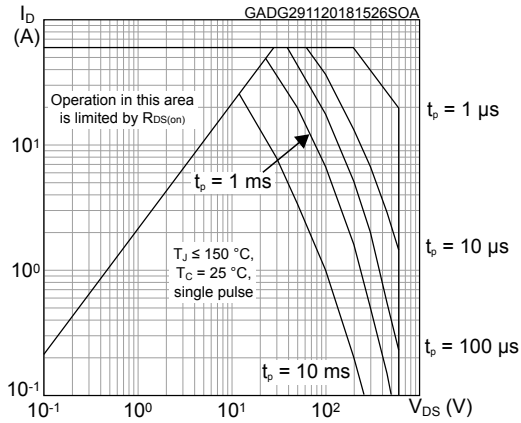

Figure 2. Normalized thermal impedance

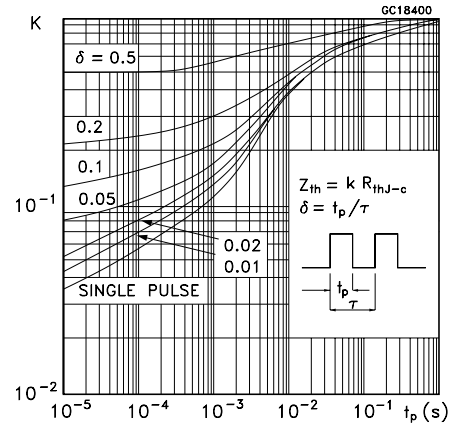

Figure 3. Output characteristics

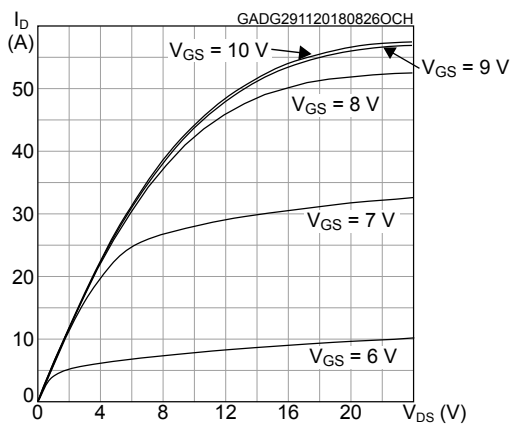

Figure 4. Transfer characteristics

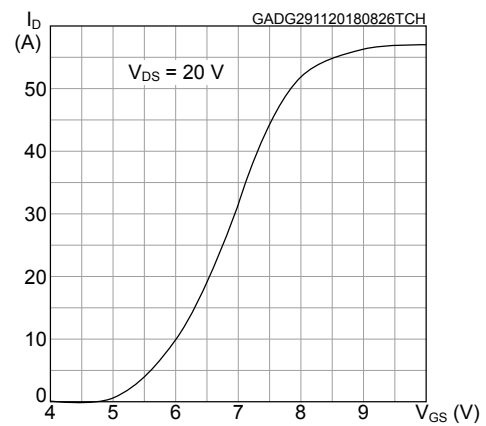

Figure 5. Gate charge vs gate-source voltage

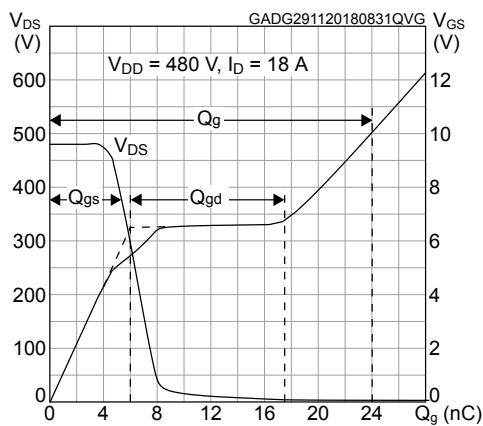

Figure 6. Capacitance variations

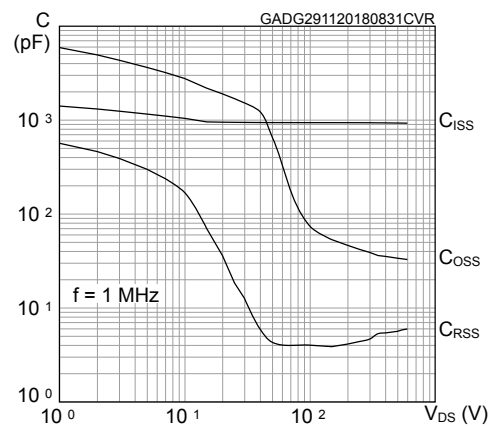

Figure 7. Static drain-source on-resistance

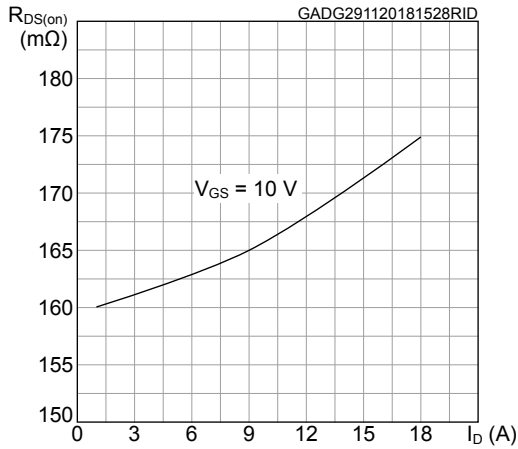

Figure 8. Normalized on-resistance vs temperature

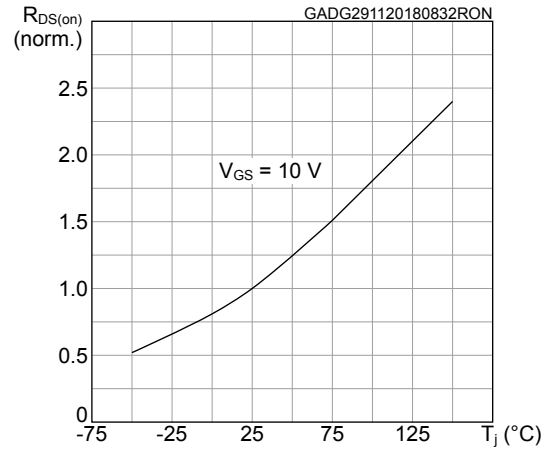

Figure 9. Normalized gate threshold voltage vs temperature

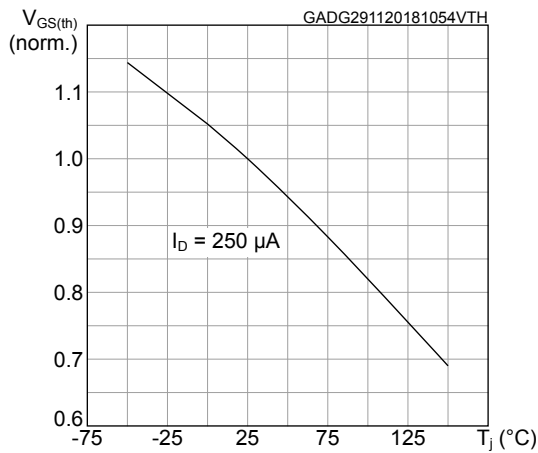

Figure 10. Normalized $V_{(BR)DSS}$ vs temperature

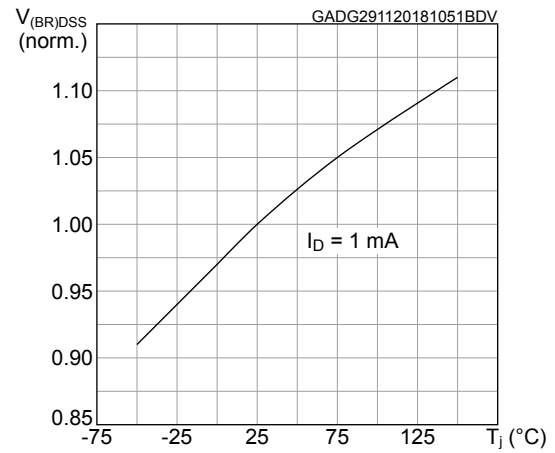

Figure 11. Output capacitance stored energy

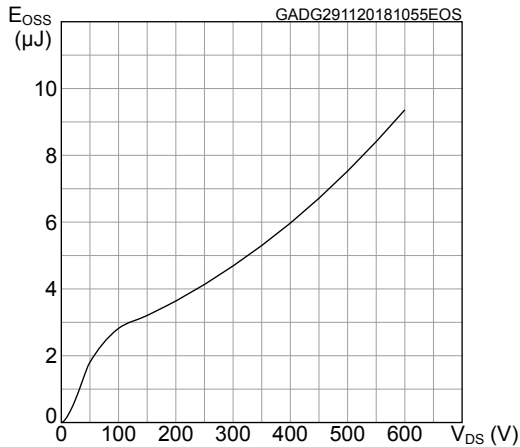
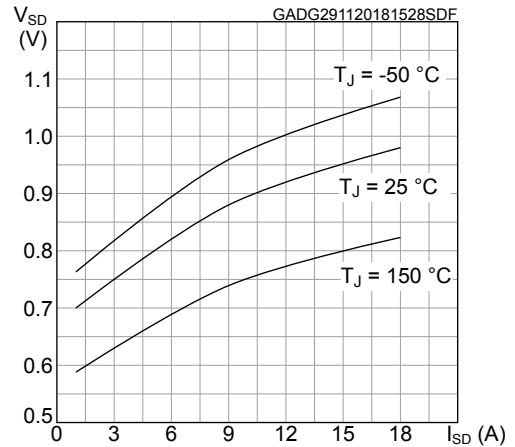
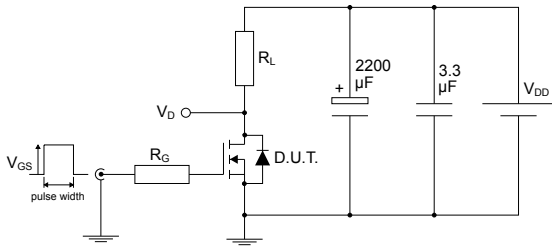

Figure 12. Source-drain diode forward characteristics



3 Test circuits

Figure 13. Test circuit for resistive load switching times



AM01468v1

Figure 14. Test circuit for gate charge behavior

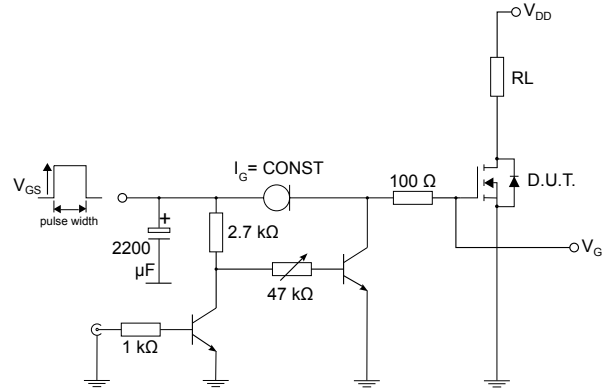

AM01469v10

Figure 15. Test circuit for inductive load switching and diode recovery times

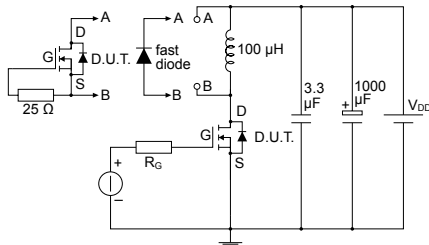

AM01470v1

Figure 16. Unclamped inductive load test circuit

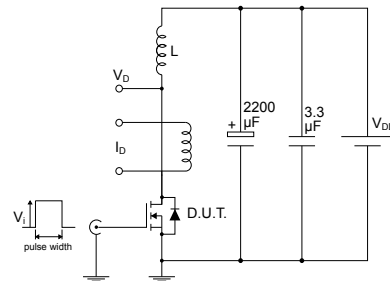

AM01471v1

Figure 17. Unclamped inductive waveform

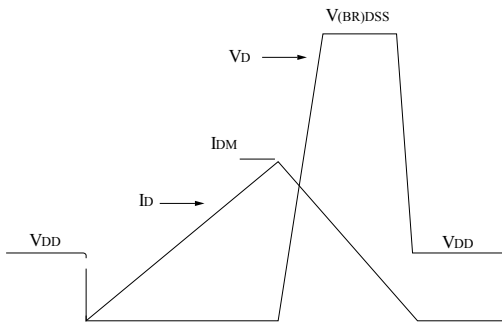

AM01472v1

Figure 18. Switching time waveform

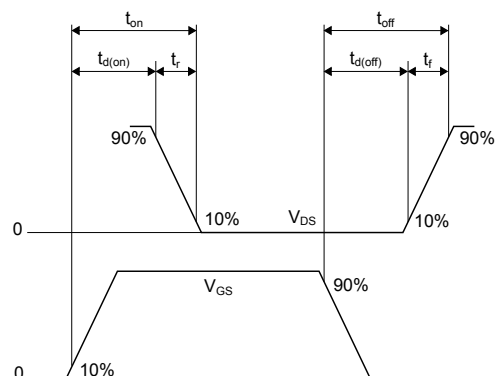

AM01473v1

4 Package information

In order to meet environmental requirements, ST offers these devices in different grades of **ECOPACK** packages, depending on their level of environmental compliance. ECOPACK specifications, grade definitions and product status are available at: www.st.com. ECOPACK is an ST trademark.

4.1 TO-220 type A package information

Figure 19. TO-220 type A package outline

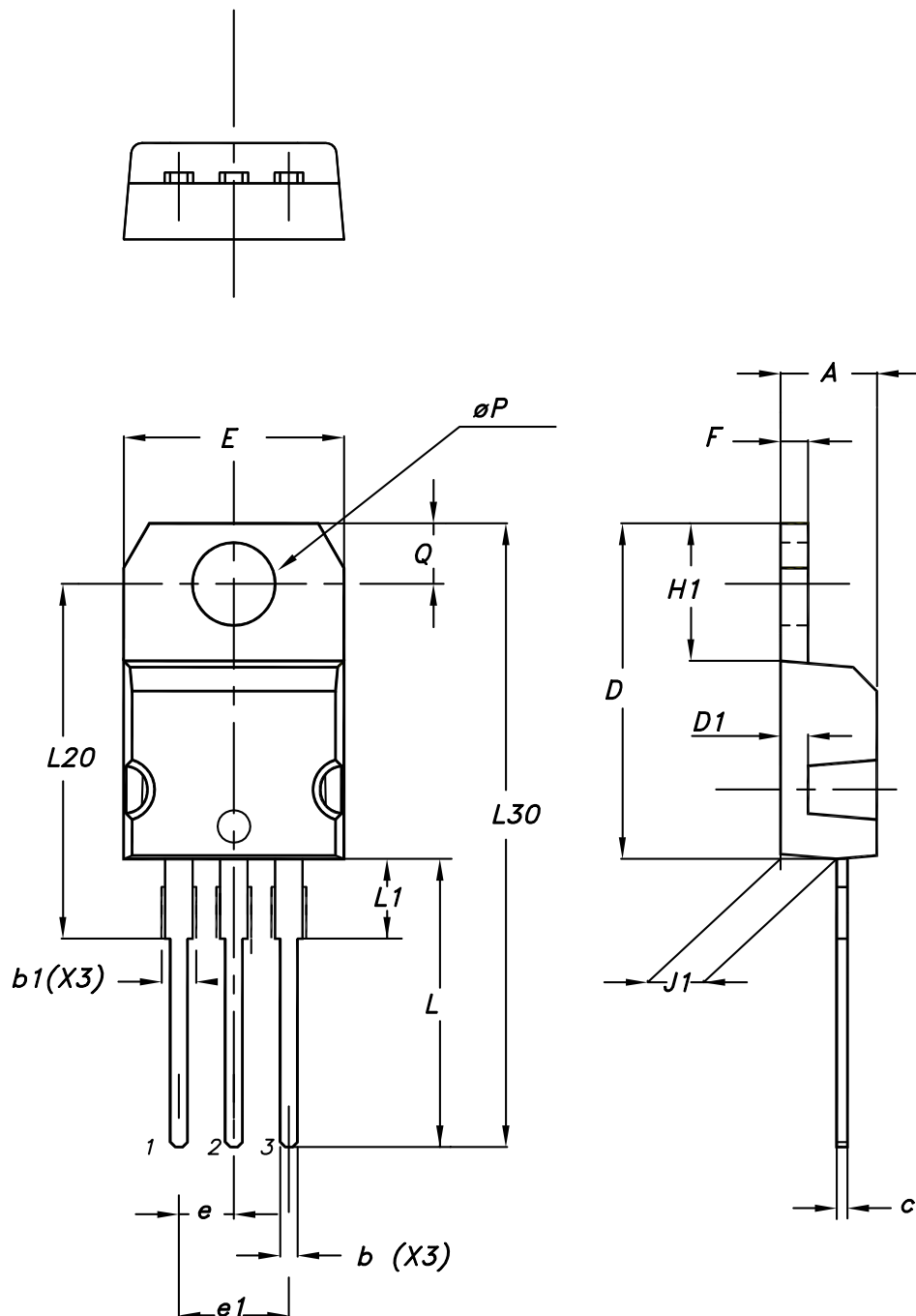

0015988_typeA_Rev_23

Table 8. TO-220 type A package mechanical data

Dim.	mm		
	Min.	Typ.	Max.
A	4.40		4.60
b	0.61		0.88
b1	1.14		1.55
c	0.48		0.70
D	15.25		15.75
D1		1.27	
E	10.00		10.40
e	2.40		2.70
e1	4.95		5.15
F	1.23		1.32
H1	6.20		6.60
J1	2.40		2.72
L	13.00		14.00
L1	3.50		3.93
L20		16.40	
L30		28.90	
øP	3.75		3.85
Q	2.65		2.95
Slug flatness		0.03	0.10

Revision history

Table 9. Document revision history

Date	Version	Changes
06-Dec-2018	1	First release.
18-Mar-2020	2	Modified Table 2. Thermal data and Table 4. On/off states.
10-Sep-2020	3	Updated Table 1.

Contents

1	Electrical ratings	2
2	Electrical characteristics	3
2.1	Electrical characteristics (curves)	5
3	Test circuits	7
4	Package information	8
4.1	TO-220 type A package information	8
	Revision history	10

IMPORTANT NOTICE – PLEASE READ CAREFULLY

STMicroelectronics NV and its subsidiaries (“ST”) reserve the right to make changes, corrections, enhancements, modifications, and improvements to ST products and/or to this document at any time without notice. Purchasers should obtain the latest relevant information on ST products before placing orders. ST products are sold pursuant to ST’s terms and conditions of sale in place at the time of order acknowledgement.

Purchasers are solely responsible for the choice, selection, and use of ST products and ST assumes no liability for application assistance or the design of Purchasers’ products.

No license, express or implied, to any intellectual property right is granted by ST herein.

Resale of ST products with provisions different from the information set forth herein shall void any warranty granted by ST for such product.

ST and the ST logo are trademarks of ST. For additional information about ST trademarks, please refer to www.st.com/trademarks. All other product or service names are the property of their respective owners.

Information in this document supersedes and replaces information previously supplied in any prior versions of this document.

© 2020 STMicroelectronics – All rights reserved

Mouser Electronics

Authorized Distributor

Click to View Pricing, Inventory, Delivery & Lifecycle Information:

[STMicroelectronics:](#)

[STP26N60DM6](#)