

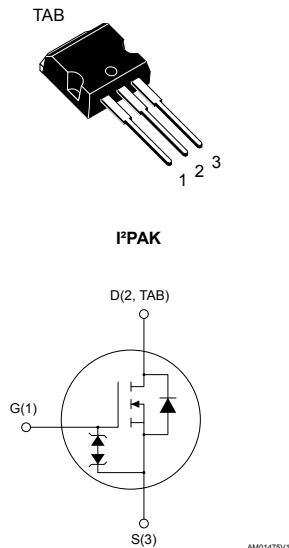

## Automotive-grade N-channel 600 V, 70 mΩ typ., 36 A MDmesh™ DM6 Power MOSFET in an I<sup>2</sup>PAK package



### Features

Order code	V <sub>DS</sub>	R <sub>DS(on)</sub> max.	I <sub>D</sub>
STI47N60DM6AG	600 V	80 mΩ	36 A

- AEC-Q101 qualified 
- Fast-recovery body diode
- Lower R<sub>DS(on)</sub> per area vs previous generation
- Low gate charge, input capacitance and resistance
- 100% avalanche tested
- Extremely high dv/dt ruggedness
- Zener-protected

### Applications

- Switching applications

### Description

This high-voltage N-channel Power MOSFET is part of the MDmesh™ DM6 fast-recovery diode series. Compared with the previous MDmesh fast generation, DM6 combines very low recovery charge (Q<sub>rr</sub>), recovery time (t<sub>rr</sub>) and excellent improvement in R<sub>DS(on)</sub> per area with one of the most effective switching behaviors available in the market for the most demanding high-efficiency bridge topologies and ZVS phase-shift converters.

#### Product status link

[STI47N60DM6AG](#)

#### Product summary

<b>Order code</b>	STI47N60DM6AG
<b>Marking</b>	47N60DM6
<b>Package</b>	I <sup>2</sup> PAK
<b>Packing</b>	Tube

# 1 Electrical ratings

**Table 1. Absolute maximum ratings**

Symbol	Parameter	Value	Unit
$V_{GS}$	Gate-source voltage	±25	V
$I_D$	Drain current (continuous) at $T_C = 25\text{ °C}$	36	A
$I_D$	Drain current (continuous) at $T_C = 100\text{ °C}$	23	A
$I_D^{(1)}$	Drain current (pulsed)	137	A
$P_{TOT}$	Total power dissipation at $T_C = 25\text{ °C}$	250	W
$dv/dt^{(2)}$	Peak diode recovery voltage slope	50	V/ns
$dv/dt^{(3)}$	MOSFET $dv/dt$ ruggedness	100	
$T_J$	Operating junction temperature range	-55 to 150	°C
$T_{stg}$	Storage temperature range		

1. Pulse width limited by safe operating area
2.  $I_{SD} \leq 36\text{ A}$ ,  $di/dt \leq 800\text{ A}/\mu\text{s}$ ,  $V_{DS(peak)} < V_{(BR)DSS}$ ,  $V_{DD} = 480\text{ V}$
3.  $V_{DS} \leq 480\text{ V}$

**Table 2. Thermal data**

Symbol	Parameter	Value	Unit
$R_{thj-case}$	Thermal resistance junction-case	0.5	°C/W
$R_{thj-amb}$	Thermal resistance junction-amb	62.5	

**Table 3. Avalanche characteristics**

Symbol	Parameter	Value	Unit
$I_{AR}$	Avalanche current, repetitive or not repetitive (pulse width limited by $T_{jmax}$ )	7	A
$E_{AS}$	Single pulse avalanche energy (starting $T_j = 25\text{ °C}$ , $I_D = I_{AR}$ , $V_{DD} = 100\text{ V}$ )	700	mJ

## 2 Electrical characteristics

$T_C = 25\text{ }^\circ\text{C}$  unless otherwise specified

**Table 4. On/off state**

Symbol	Parameter	Test conditions	Min.	Typ.	Max.	Unit
$V_{(BR)DSS}$	Drain-source breakdown voltage	$V_{GS} = 0\text{ V}$ , $I_D = 1\text{ mA}$	600			V
$I_{DSS}$	Zero gate voltage drain current	$V_{GS} = 0\text{ V}$ , $V_{DS} = 600\text{ V}$			1	$\mu\text{A}$
		$V_{GS} = 0\text{ V}$ , $V_{DS} = 600\text{ V}$ , $T_C = 125\text{ }^\circ\text{C}^{(1)}$			100	$\mu\text{A}$
$I_{GSS}$	Gate body leakage current	$V_{DS} = 0\text{ V}$ , $V_{GS} = \pm 25\text{ V}$			$\pm 1$	$\mu\text{A}$
$V_{GS(th)}$	Gate threshold voltage	$V_{DS} = V_{GS}$ , $I_D = 250\text{ }\mu\text{A}$	3.25	4	4.75	V
$R_{DS(on)}$	Static drain-source on-resistance	$V_{GS} = 10\text{ V}$ , $I_D = 18\text{ A}$		70	80	$\text{m}\Omega$

1. Defined by design, not subject to production test.

**Table 5. Dynamic**

Symbol	Parameter	Test conditions	Min.	Typ.	Max.	Unit
$C_{iss}$	Input capacitance	$V_{DS} = 100\text{ V}$ , $f = 1\text{ MHz}$ , $V_{GS} = 0\text{ V}$	-	2350	-	$\text{pF}$
$C_{oss}$	Output capacitance		-	160	-	$\text{pF}$
$C_{rss}$	Reverse transfer capacitance		-	2	-	$\text{pF}$
$C_{oss\text{ eq.}}^{(1)}$	Equivalent output capacitance	$V_{DS} = 0\text{ to }480\text{ V}$ , $V_{GS} = 0\text{ V}$	-	416	-	$\text{pF}$
$R_G$	Intrinsic gate resistance	$f = 1\text{ MHz}$ open drain	-	1.6	-	$\Omega$
$Q_g$	Total gate charge	$V_{DD} = 480\text{ V}$ , $I_D = 36\text{ A}$ ,	-	55	-	$\text{nC}$
$Q_{gs}$	Gate-source charge	$V_{GS} = 0\text{ to }10\text{ V}$	-	12	-	$\text{nC}$
$Q_{gd}$	Gate-drain charge	(see Figure 14. Test circuit for gate charge behavior)	-	31	-	$\text{nC}$

1.  $C_{oss\text{ eq.}}$  is defined as a constant equivalent capacitance giving the same charging time as  $C_{oss}$  when  $V_{DS}$  increases from 0 to 80%  $V_{DSS}$ .

**Table 6. Switching times**

Symbol	Parameter	Test conditions	Min.	Typ.	Max.	Unit
$t_{d(on)}$	Turn-on delay time	$V_{DD} = 300\text{ V}$ , $I_D = 18\text{ A}$ ,	-	23	-	ns
$t_r$	Rise time	$R_G = 4.7\text{ }\Omega$ , $V_{GS} = 10\text{ V}$	-	5.5	-	ns
$t_{d(off)}$	Turn-off delay time	(see Figure 13. Test circuit for resistive load switching times and Figure 18. Switching time waveform)	-	57	-	ns
$t_f$	Fall time		-	9	-	ns

**Table 7. Source-drain diode**

Symbol	Parameter	Test conditions	Min.	Typ.	Max.	Unit
$I_{SD}$	Source-drain current		-		36	A
$I_{SDM}^{(1)}$	Source-drain current (pulsed)		-		137	A
$V_{SD}^{(2)}$	Forward on voltage	$I_{SD} = 36\text{ A}$ , $V_{GS} = 0\text{ V}$	-		1.6	V
$t_{rr}$	Reverse recovery time	$I_{SD} = 36\text{ A}$ , $di/dt = 100\text{ A}/\mu\text{s}$ , $V_{DD} = 60\text{ V}$	-	115		ns
$Q_{rr}$	Reverse recovery charge		-	0.54		$\mu\text{C}$
$I_{RRM}$	Reverse recovery current	(see Figure 15. Test circuit for inductive load switching and diode recovery times)	-	9.5		A
$t_{rr}$	Reverse recovery time	$I_{SD} = 36\text{ A}$ , $di/dt = 100\text{ A}/\mu\text{s}$ , $V_{DD} = 60\text{ V}$ , $T_j = 150\text{ }^\circ\text{C}$	-	210		ns
$Q_{rr}$	Reverse recovery charge		-	2.1		$\mu\text{C}$
$I_{RRM}$	Reverse recovery current		(see Figure 15. Test circuit for inductive load switching and diode recovery times)	-	20.4	

1. Pulse width limited by safe operating area
2. Pulsed: pulse duration = 300  $\mu\text{s}$ , duty cycle 1.5%

**Table 8. Gate-source Zener diode**

Symbol	Parameter	Test conditions	Min.	Typ.	Max.	Unit
$V_{(BR)GSO}$	Gate-source breakdown voltage	$I_{GS} = \pm 1\text{ mA}$ , $I_D = 0\text{ A}$	$\pm 30$	-	-	V

The built-in back-to-back Zener diodes are specifically designed to enhance the ESD performance of the device. The Zener voltage facilitates efficient and cost-effective device integrity protection, thus eliminating the need for additional external componentry.

## 2.1 Electrical characteristics (curves)

Figure 1. Safe operating area

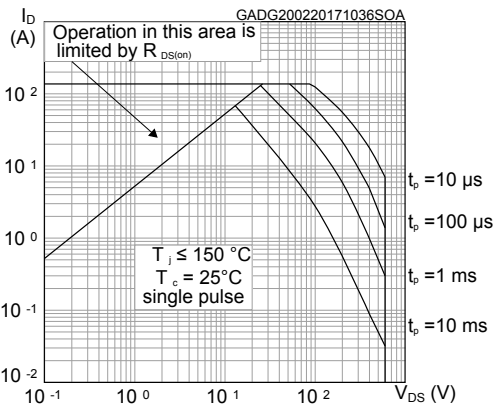

Figure 2. Thermal impedance

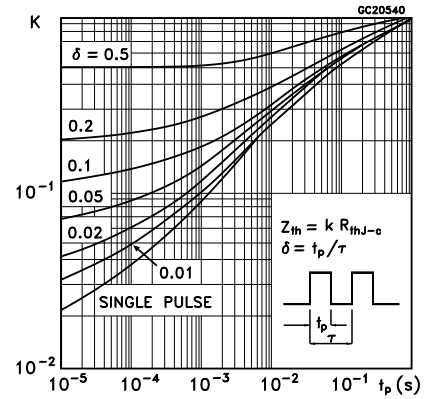

Figure 3. Output characteristics

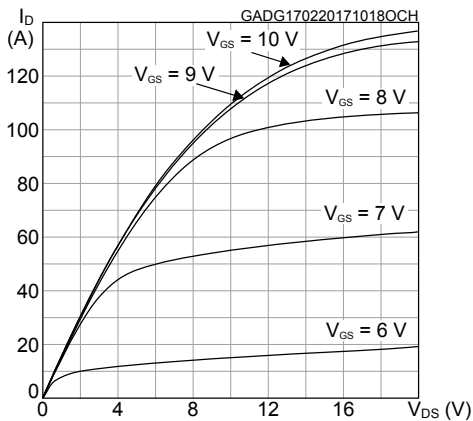

Figure 4. Transfer characteristics

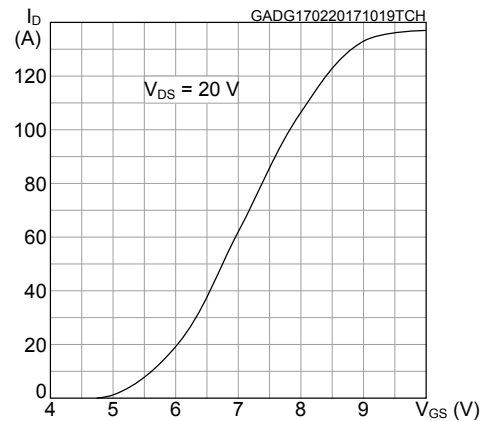

Figure 5. Gate charge vs gate-source voltage

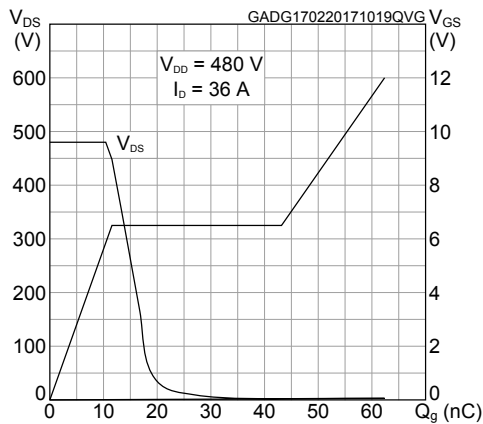

Figure 6. Static drain-source on-resistance

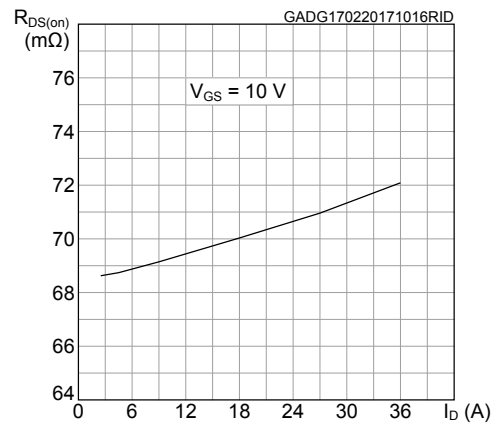

Figure 7. Capacitance variations

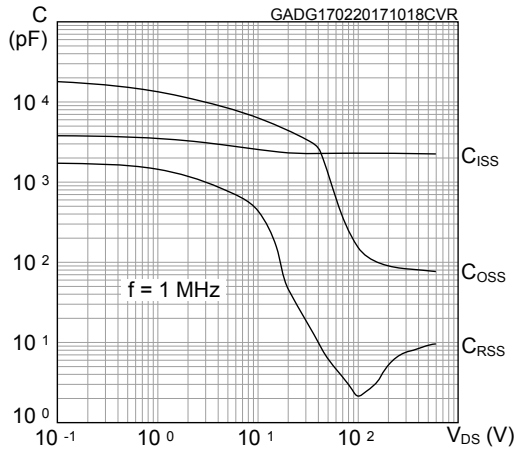

Figure 8. Normalized gate threshold voltage vs temperature

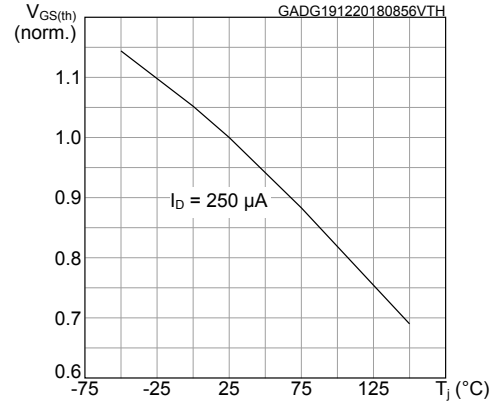

Figure 9. Normalized on-resistance vs temperature

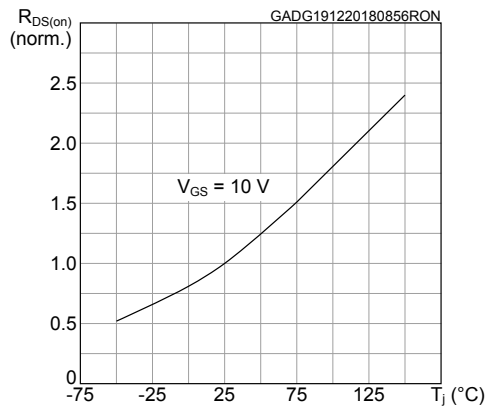

Figure 10. Normalized  $V_{(BR)DSS}$  vs temperature

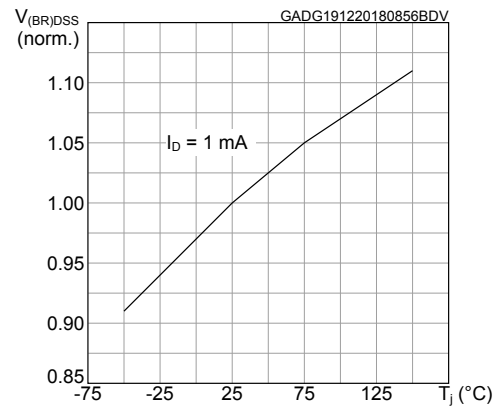

Figure 11. Source-drain diode forward characteristics

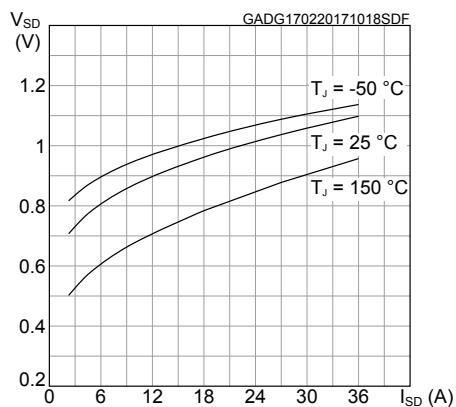
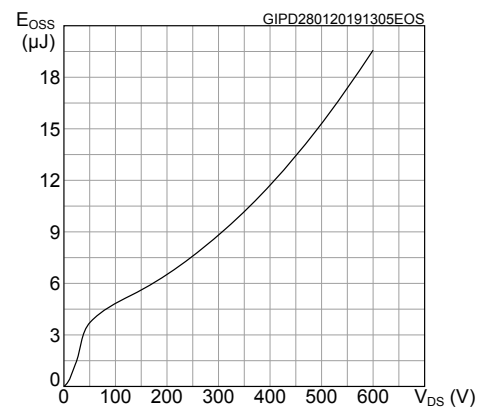

Figure 12. Output capacitance stored energy





## 4 Package information

---

In order to meet environmental requirements, ST offers these devices in different grades of **ECOPACK<sup>®</sup>** packages, depending on their level of environmental compliance. ECOPACK<sup>®</sup> specifications, grade definitions and product status are available at: [www.st.com](http://www.st.com). ECOPACK<sup>®</sup> is an ST trademark.



#### 4.1 I<sup>2</sup>PAK package information

Figure 19. I<sup>2</sup>PAK package outline

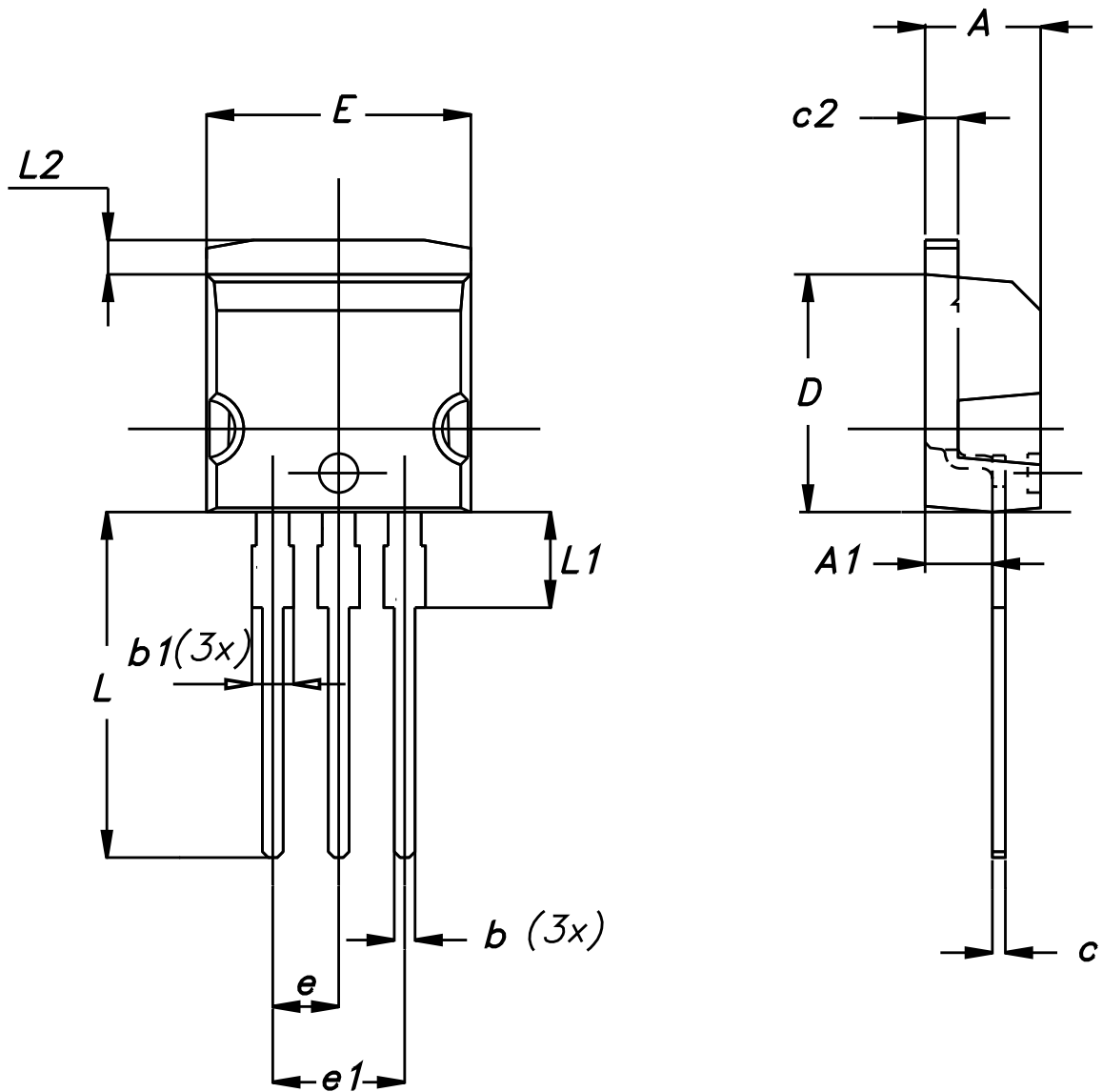

0004982\_Rev\_H

**Table 9.** I<sup>2</sup>PAK package mechanical data

Dim.	mm		
	Min.	Typ.	Max.
A	4.40	-	4.60
A1	2.40	-	2.72
b	0.61	-	0.88
b1	1.14	-	1.70
c	0.49	-	0.70
c2	1.23	-	1.32
D	8.95	-	9.35
e	2.40	-	2.70
e1	4.95	-	5.15
E	10	-	10.40
L	13	-	14
L1	3.50	-	3.93
L2	1.27	-	1.40

## Revision history

**Table 10. Document revision history**

Date	Revision	Changes
12-Apr-2017	1	Initial release.
15-Mar-2018	2	Removed maturity status indication from cover page. The document status is production data.
11-Mar-2019	3	Modified <a href="#">Table 1. Absolute maximum ratings</a> . Added <a href="#">Figure 12. Output capacitance stored energy</a> . Minor text changes.

## Contents

<b>1</b>	<b>Electrical ratings</b> .....	<b>2</b>
<b>2</b>	<b>Electrical characteristics</b> .....	<b>3</b>
<b>2.1</b>	<b>Electrical characteristics (curves)</b> .....	<b>5</b>
<b>3</b>	<b>Test circuits</b> .....	<b>7</b>
<b>4</b>	<b>Package information</b> .....	<b>8</b>
<b>4.1</b>	<b>I<sup>2</sup>PAK package information</b> .....	<b>8</b>
	<b>Revision history</b> .....	<b>11</b>
	<b>Contents</b> .....	<b>12</b>

**IMPORTANT NOTICE – PLEASE READ CAREFULLY**

STMicroelectronics NV and its subsidiaries (“ST”) reserve the right to make changes, corrections, enhancements, modifications, and improvements to ST products and/or to this document at any time without notice. Purchasers should obtain the latest relevant information on ST products before placing orders. ST products are sold pursuant to ST’s terms and conditions of sale in place at the time of order acknowledgement.

Purchasers are solely responsible for the choice, selection, and use of ST products and ST assumes no liability for application assistance or the design of Purchasers’ products.

No license, express or implied, to any intellectual property right is granted by ST herein.

Resale of ST products with provisions different from the information set forth herein shall void any warranty granted by ST for such product.

ST and the ST logo are trademarks of ST. For additional information about ST trademarks, please refer to [www.st.com/trademarks](http://www.st.com/trademarks). All other product or service names are the property of their respective owners.

Information in this document supersedes and replaces information previously supplied in any prior versions of this document.

© 2019 STMicroelectronics – All rights reserved

# Mouser Electronics

Authorized Distributor

Click to View Pricing, Inventory, Delivery & Lifecycle Information:

[STMicroelectronics:](#)

[STI47N60DM6AG](#)