

P-channel -40 V, 12.5 mΩ typ., -10 A STripFET F6 Power MOSFET in SO-8 package

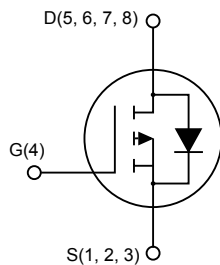
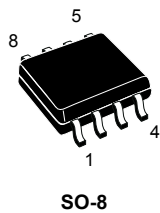

AM01475v4

Features

Order code	V_{DS}	$R_{DS(on)}$ max.	I_D
STS10P4LLF6	-40 V	15 mΩ	-10 A

- Very low on-resistance
- Very low gate charge
- High avalanche ruggedness
- Low gate drive power loss

Applications

- Switching applications

Description

This device is a P-channel Power MOSFET developed using the STripFET F6 technology, with a new trench gate structure. The resulting Power MOSFET exhibits very low $R_{DS(on)}$ in all packages.



Product status link

[STS10P4LLF6](#)

Product summary

Order code	STS10P4LLF6
Marking	10P4L
Package	SO-8
Packing	Tape and reel

1 Electrical ratings

Table 1. Absolute maximum ratings

Symbol	Parameter	Value	Unit
V_{DS}	Drain-source voltage	-40	V
V_{GS}	Gate-source voltage	± 20	V
I_D	Drain current (continuous) at $T_{amb} = 25\text{ }^\circ\text{C}$	-10	A
	Drain current (continuous) at $T_{amb} = 100\text{ }^\circ\text{C}$	-5.6	A
$I_{DM}^{(1)}$	Drain current (pulsed)	-40	A
P_{TOT}	Total power dissipation at $T_{amb} = 25\text{ }^\circ\text{C}$	2.7	W
T_{stg}	Storage temperature	-55 to 150	$^\circ\text{C}$
T_J	Operating junction temperature	150	$^\circ\text{C}$

1. Pulse width limited by safe operating area.

Table 2. Thermal data

Symbol	Parameter	Value	Unit
$R_{thJA}^{(1)}$	Thermal resistance, junction-to-ambient	47	$^\circ\text{C/W}$

1. When mounted on 1 inch² FR-4 board, 2 oz. Cu., $t \leq 10$ sec.

2 Electrical characteristics

($T_C = 25\text{ °C}$ unless otherwise specified)

Table 3. Static

Symbol	Parameter	Test conditions	Min.	Typ.	Max.	Unit
$V_{(BR)DSS}$	Drain-source breakdown voltage	$I_D = -250\text{ }\mu\text{A}$	-40			V
I_{DSS}	Zero gate voltage drain current	$V_{DS} = -40\text{ V}$			-1	μA
		$V_{DS} = -40\text{ V}$, $T_C = 125\text{ °C}$			-10	μA
I_{GSS}	Gate-body leakage current	$V_{DS} = 0\text{ V}$, $V_{GS} = \pm 20\text{ V}$			± 100	nA
$V_{GS(th)}$	Gate threshold voltage	$V_{DS} = V_{GS}$, $I_D = -250\text{ }\mu\text{A}$	-1		-2.5	V
$R_{DS(on)}$	Static drain-source on-resistance	$V_{GS} = -10\text{ V}$, $I_D = -3\text{ A}$		12.5	15	m Ω
		$V_{GS} = -4.5\text{ V}$, $I_D = -3\text{ A}$		17	20	

Table 4. Dynamic

Symbol	Parameter	Test conditions	Min.	Typ.	Max.	Unit
C_{iss}	Input capacitance	$V_{DS} = -25\text{ V}$, $f = 1\text{ MHz}$, $V_{GS} = 0\text{ V}$	-	3525	-	pF
C_{oss}	Output capacitance		-	344	-	pF
C_{rss}	Reverse transfer capacitance		-	238.5	-	pF
Q_g	Total gate charge	$V_{DD} = -20\text{ V}$, $I_D = -10\text{ A}$, $V_{GS} = -4.5\text{ V}$ (see Figure 13. Test circuit for gate charge behavior)	-	34	-	nC
Q_{gs}	Gate-source charge		-	11.3	-	nC
Q_{gd}	Gate-drain charge		-	13.8	-	nC

Table 5. Switching times

Symbol	Parameter	Test conditions	Min.	Typ.	Max.	Unit
$t_{d(on)}$	Turn-on delay time	$V_{DD} = -20\text{ V}$, $I_D = -5\text{ A}$, $R_G = 4.7\text{ }\Omega$, $V_{GS} = -10\text{ V}$ (see Figure 12. Test circuit for resistive load switching times)	-	49.4	-	ns
t_r	Rise time		-	60.6	-	ns
$t_{d(off)}$	Turn-off-delay time		-	170	-	ns
t_f	Fall time		-	20	-	ns

Table 6. Source drain diode

Symbol	Parameter	Test conditions	Min.	Typ.	Max.	Unit
$V_{SD}^{(1)}$	Forward on voltage	$V_{GS} = 0\text{ V}$, $I_{SD} = -3\text{ A}$	-		-1.1	V
t_{rr}	Reverse recovery time	$I_{SD} = -5\text{ A}$, $di/dt = 100\text{ A}/\mu\text{s}$, $V_{DD} = -32\text{ V}$, $T_J = 150\text{ °C}$ (see Figure 14. Test circuit for inductive load switching and diode recovery times)	-	29		ns
Q_{rr}	Reverse recovery charge		-	27.6		nC
I_{RRM}	Reverse recovery current		-	-1.9		A

1. Pulse test: pulse duration = 300 μs , duty cycle 1.5%.

2.1 Electrical characteristics (curves)

Figure 1. Safe operating area

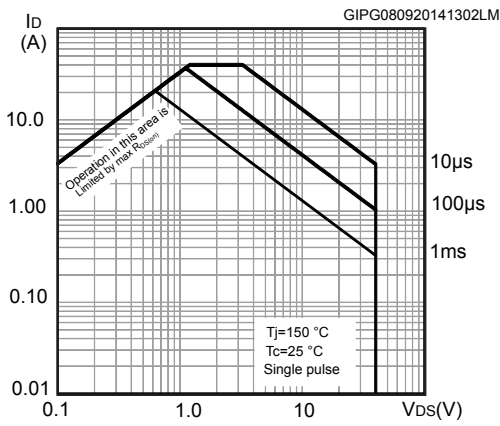

Figure 2. Thermal impedance

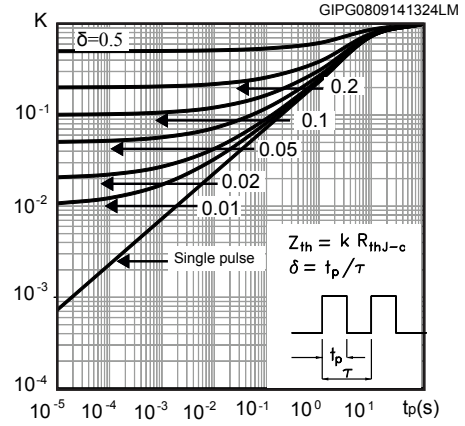

Figure 3. Output characteristics

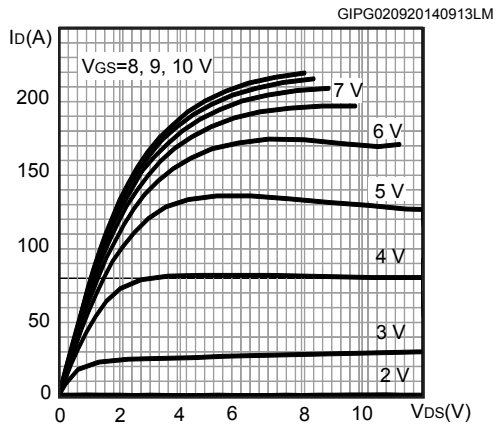

Figure 4. Transfer characteristics

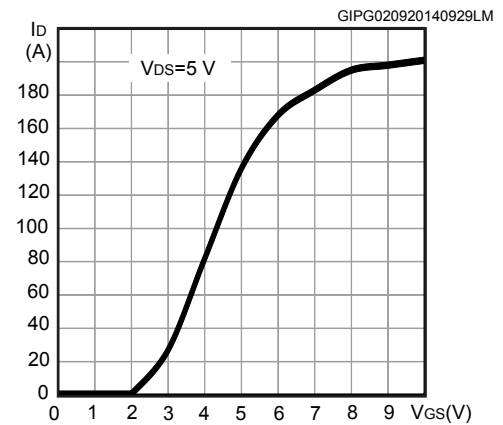

Figure 5. Gate charge vs gate-source voltage

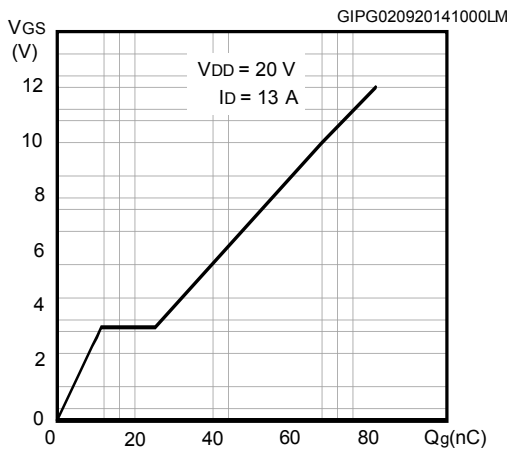
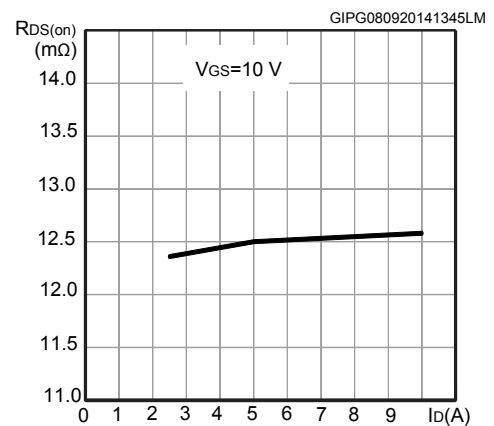

Figure 6. Static drain-source on-resistance



Note: For the P-channel Power MOSFET, current and voltage polarities are reversed.

Figure 7. Capacitance variation

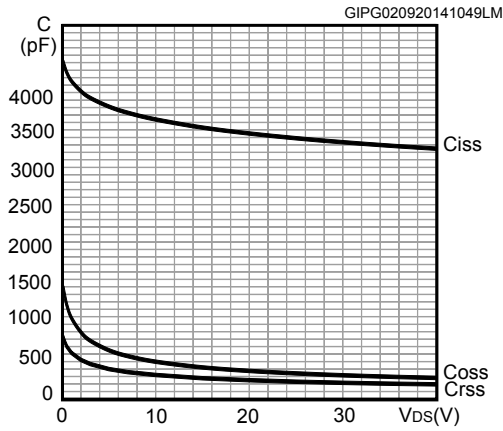

Figure 8. Normalized gate threshold voltage vs temperature

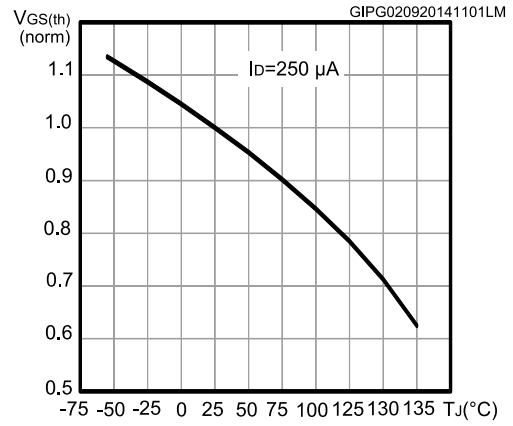

Figure 9. Normalized on-resistance vs temperature

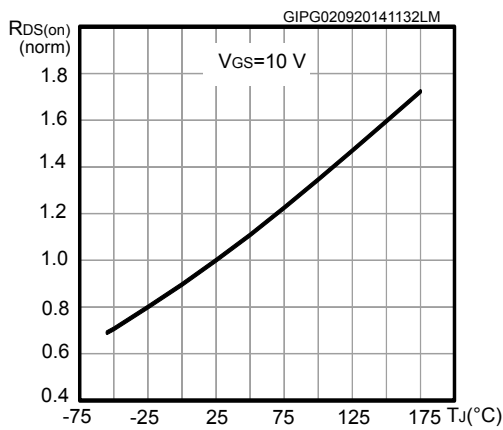

Figure 10. Normalized VBR(DSS) vs temperature

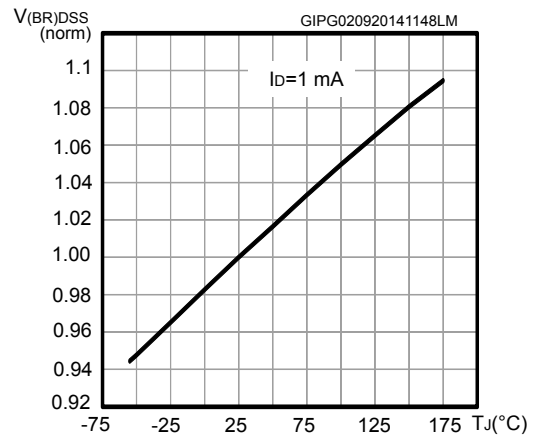
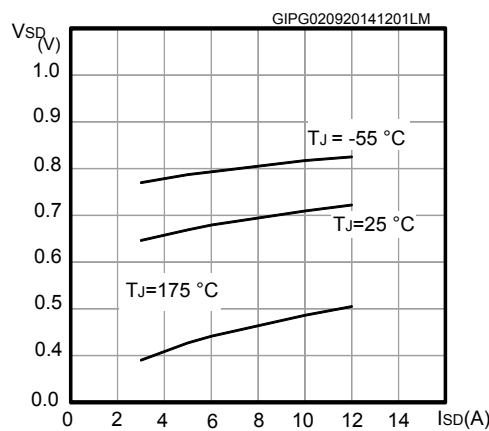

Figure 11. Source-drain diode forward characteristics



Note: For the P-channel Power MOSFET, current and voltage polarities are reversed.

3 Test circuits

Figure 12. Test circuit for resistive load switching times

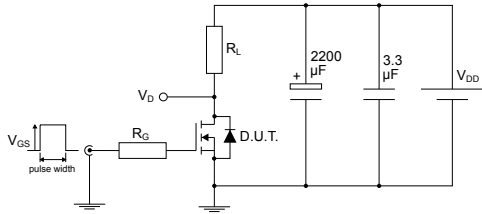

AM01468v1

Figure 13. Test circuit for gate charge behavior

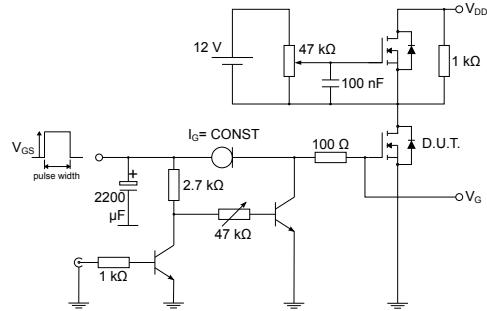

AM01469v1

Figure 14. Test circuit for inductive load switching and diode recovery times

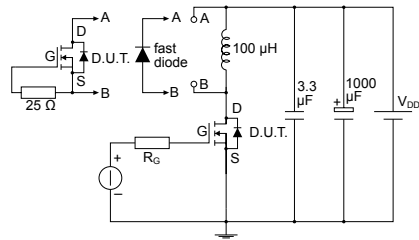

AM01470v1

Figure 15. Unclamped inductive load test circuit

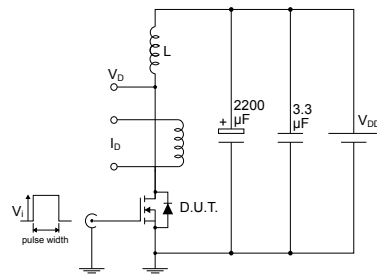

AM01471v1

Figure 16. Unclamped inductive waveform

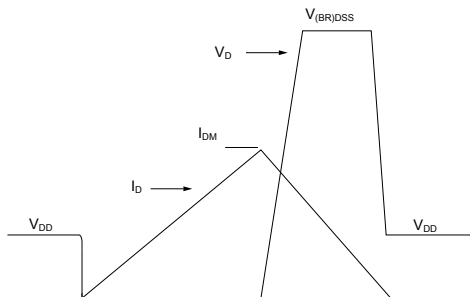

AM01472v1

Figure 17. Switching time waveform

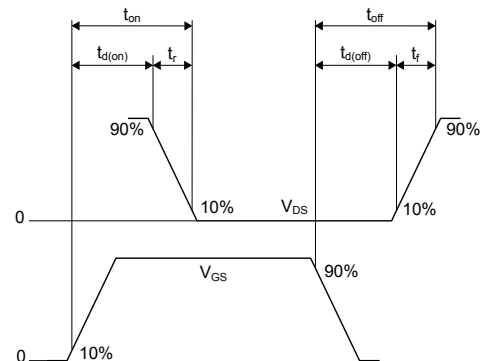

AM01473v1

4 Package information

In order to meet environmental requirements, ST offers these devices in different grades of **ECOPACK** packages, depending on their level of environmental compliance. ECOPACK specifications, grade definitions and product status are available at: www.st.com. ECOPACK is an ST trademark.

4.1 SO-8 package information

Figure 18. SO-8 package outline

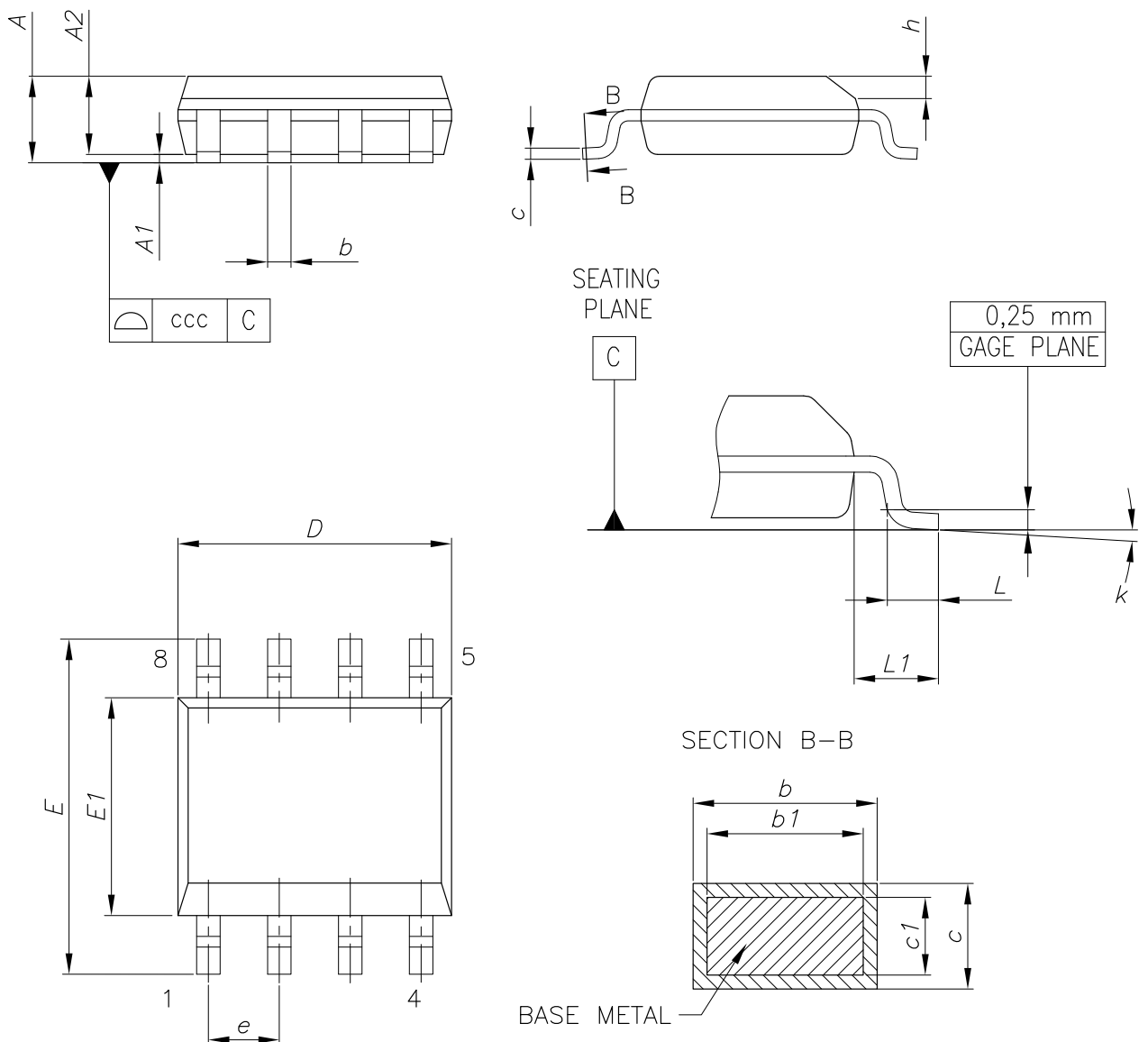

0016023_So-807_fig2_Rev10

Table 7. SO-8 mechanical data

Dim.	mm		
	Min.	Typ.	Max.
A			1.75
A1	0.10		0.25
A2	1.25		
b	0.31		0.51
b1	0.28		0.48
c	0.10		0.25
c1	0.10		0.23
D	4.80	4.90	5.00
E	5.80	6.00	6.20
E1	3.80	3.90	4.00
e		1.27	
h	0.25		0.50
L	0.40		1.27
L1		1.04	
L2		0.25	
k	0°		8°
ccc			0.10

Figure 19. SO-8 recommended footprint (dimensions are in mm)

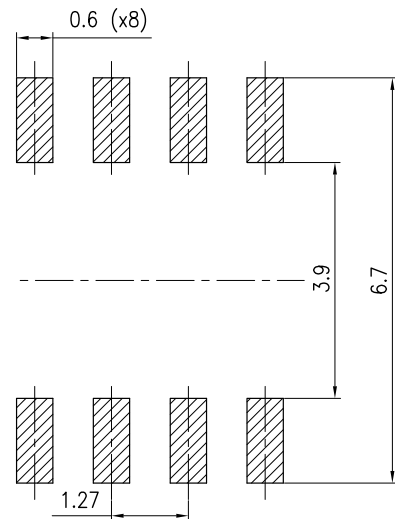

0016023_So-807_footprint_Rev10

4.2 SO-8 packing information

Figure 20. SO-8 tape and reel dimensions

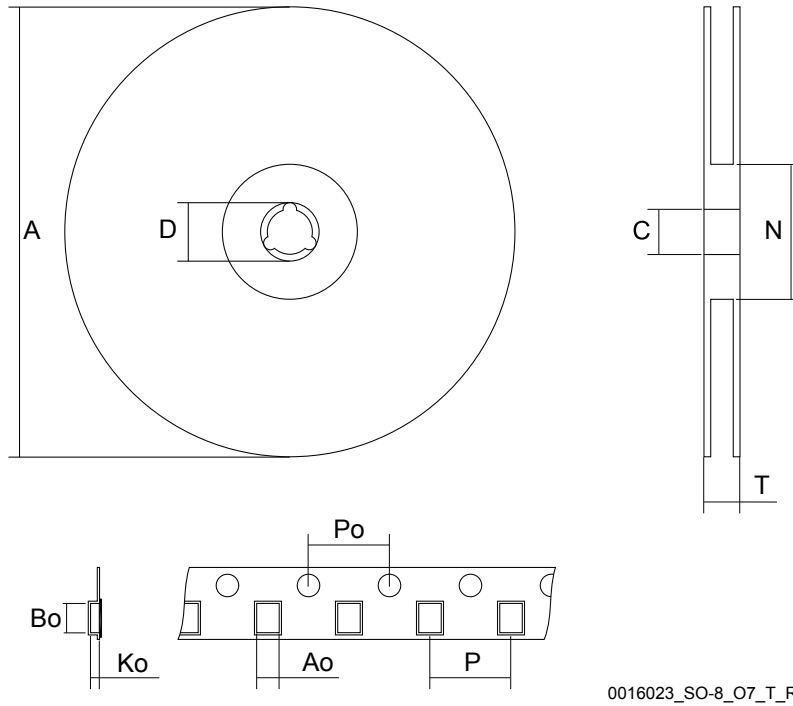

Figure 21. Tape orientation

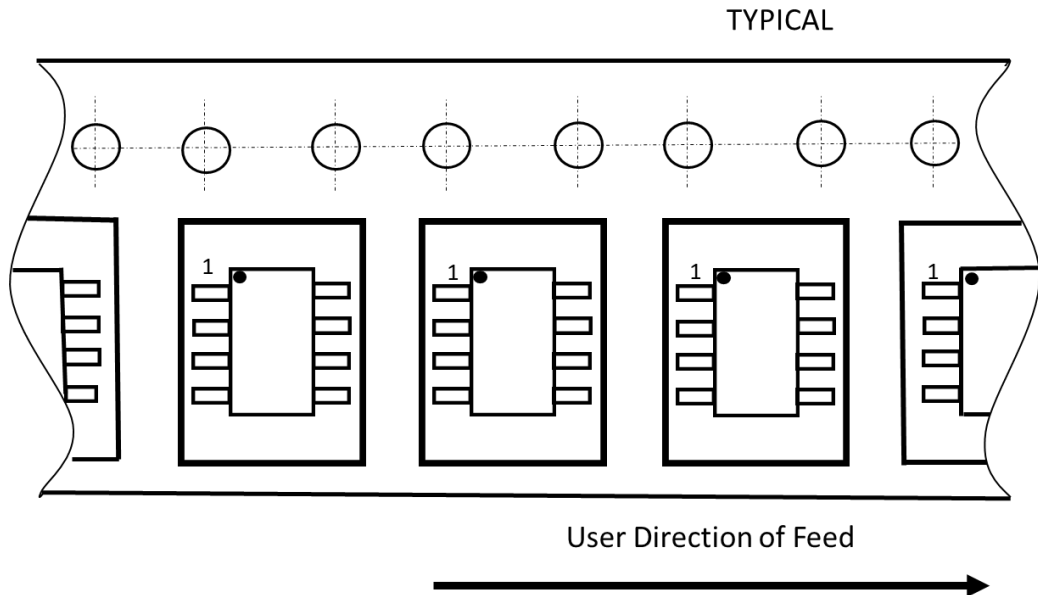

Table 8. SO-8 tape and reel mechanical data

Dim.	mm		
	Min.	Typ.	Max.
A			330
C	12.8		13.2
D	20.2		
N	60		
T			22.4
Ao	6.5	-	6.7
Bo	5.4		5.6
Ko	2.0		2.2
Po	3.9		4.1
P	7.9		8.1

Revision history

Table 9. Document revision history

Date	Revision	Changes
20-Jan-2014	1	First revision.
09-Sep-2014	2	<p>Changed the title.</p> <p>Updated <i>Section "Features" and Section "Description"</i>.</p> <p>Updated <i>Table 4: "On/off states", Table 5: "Dynamic", Table 6: "Switching times", Table 7: "Source-drain diode"</i>.</p> <p>Added <i>Section 3: "Electrical characteristics (curves)"</i>.</p>
16-Dec-2014	3	<p>Document status promoted from preliminary data to production data.</p> <p>Minor text changes.</p>
09-Dec-2020	4	<p>Updated title and features in cover page.</p> <p>Updated <i>Section 1 Electrical ratings and Section 2 Electrical characteristics</i>.</p> <p>Minor text changes.</p>
21-Jan-2021	5	<p>Updated Internal schematic.</p> <p>Minor text changes.</p>

Contents

1	Electrical ratings	2
2	Electrical characteristics	3
2.1	Electrical characteristics (curves)	4
3	Test circuits	6
4	Package information	7
4.1	SO-8 package information	7
4.2	SO-8 packing information	9
	Revision history	11

IMPORTANT NOTICE – PLEASE READ CAREFULLY

STMicroelectronics NV and its subsidiaries (“ST”) reserve the right to make changes, corrections, enhancements, modifications, and improvements to ST products and/or to this document at any time without notice. Purchasers should obtain the latest relevant information on ST products before placing orders. ST products are sold pursuant to ST’s terms and conditions of sale in place at the time of order acknowledgement.

Purchasers are solely responsible for the choice, selection, and use of ST products and ST assumes no liability for application assistance or the design of Purchasers’ products.

No license, express or implied, to any intellectual property right is granted by ST herein.

Resale of ST products with provisions different from the information set forth herein shall void any warranty granted by ST for such product.

ST and the ST logo are trademarks of ST. For additional information about ST trademarks, please refer to www.st.com/trademarks. All other product or service names are the property of their respective owners.

Information in this document supersedes and replaces information previously supplied in any prior versions of this document.

© 2021 STMicroelectronics – All rights reserved

Mouser Electronics

Authorized Distributor

Click to View Pricing, Inventory, Delivery & Lifecycle Information:

[STMicroelectronics:](#)

[STS10P4LLF6](#)