

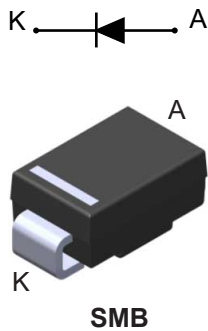

Automotive 200 V, 2 A ultrafast recovery diode



Features

- AEC-Q101 qualified 
- Very low conduction losses
- Negligible switching losses
- Low forward and reverse recovery times
- High junction temperature
- PPAP capable
- ECOPACK2 compliant

Applications

- High frequency inverters
- Freewheeling diode
- Polarity protection
- Reverse battery protection

Description

This 2 A, 200 V uses ST's 200 V planar Pt doping technology, and it is specially suited for switching mode base drive and transistor circuits.

Product status	
STTH2R02-Y	
Product summary	
Symbol	Value
$I_{F(AV)}$	2 A
V_{RRM}	200 V
$T_{j(max.)}$	175 °C
$V_F(typ.)$	0.7 V
$t_{rr}(typ.)$	15 ns

1 Characteristics

Table 1. Absolute ratings (limiting values at 25 °C, unless otherwise specified)

Symbol	Parameter	Value	Unit
V _{RRM}	Repetitive peak reverse voltage (T _j = -40 °C to +175 °C)	200	V
I _{FRM}	Repetitive peak forward current	t _p = 5 μs, f = 5 kHz	A
I _{F(RMS)}	Forward rms current	60	A
I _{F(AV)}	Average forward current δ = 0.5, square wave	T _L = 90 °C	A
I _{FSM}	Surge non repetitive forward current	t _p = 10 ms sinusoidal	A
T _{stg}	Storage temperature range	-65 to +175	°C
T _j	Operating junction temperature range ⁽¹⁾	-40 to +175	°C

1. $(dP_{tot}/dT_j) < (1/R_{th(j-a)})$ condition to avoid thermal runaway for a diode on its own heatsink.

Table 2. Thermal resistance parameter

Symbol	Parameter	Max. value	Unit
R _{th(j-l)}	Junction to lead	30	°C/W

For more information, please refer to the following application note :

- AN5088 : Rectifiers thermal management, handling and mounting recommendations

Table 3. Static electrical characteristics

Symbol	Parameter	Test conditions	Min.	Typ.	Max.	Unit	
I _R ⁽¹⁾	Reverse leakage current	T _j = 25 °C	V _R = V _{RRM}	-		3	μA
		T _j = 125 °C		-	2	20	
V _F ⁽²⁾	Forward voltage drop	T _j = 25 °C	I _F = 6 A	-		1.20	V
		T _j = 25 °C		-	0.89	1.00	
		T _j = 100 °C	I _F = 2 A	-	0.76	0.85	
		T _j = 150 °C		-	0.70	0.80	

1. Pulse test: t_p = 5 ms, δ < 2%

2. Pulse test: t_p = 380 μs, δ < 2%

To evaluate the conduction losses, use the following equation:

$$P = 0.68 \times I_{F(AV)} + 0.06 \times I_{F(RMS)}^2$$

For more information, please refer to the following application notes related to the power losses :

- AN604: Calculation of conduction losses in a power rectifier
- AN4021: Calculation of reverse losses on a power diode

Table 4. Dynamic characteristics ($T_j = 25\text{ °C}$ unless otherwise specified)

Symbol	Parameters	Test conditions	Min.	Typ.	Max.	Unit
t_{rr}	Reverse recovery time	$I_F = 1\text{ A}$, $di_F/dt = -50\text{ A}/\mu\text{s}$, $V_R = 30\text{ V}$	-	23	30	ns
		$I_F = 1\text{ A}$, $di_F/dt = -100\text{ A}/\mu\text{s}$, $V_R = 30\text{ V}$	-	15	20	
I_{RM}	Reverse recovery current	$I_F = 2\text{ A}$, $di_F/dt = -200\text{ A}/\mu\text{s}$, $V_R = 160\text{ V}$, $T_j = 125\text{ °C}$	-	3	4	A
t_{fr}	Forward recovery time	$I_F = 2\text{ A}$, $di_F/dt = 100\text{ A}/\mu\text{s}$, $V_{FR} = 1.1 V_{F(max.)}$	-	40		ns
V_{FP}	Forward recovery voltage	$I_F = 2\text{ A}$, $di_F/dt = 100\text{ A}/\mu\text{s}$	-	2.0		V

1.1 Characteristics (curves)

Figure 1. Peak current versus duty cycle

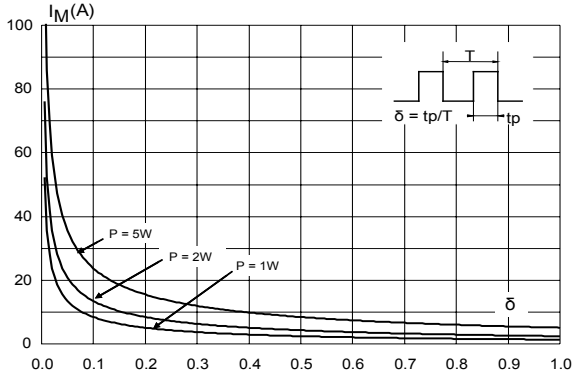

Figure 2. Average forward power dissipation versus average forward current

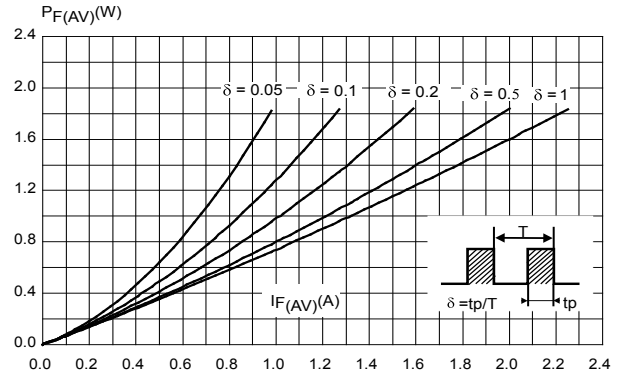

Figure 3. Forward voltage drop versus forward current (typical values)

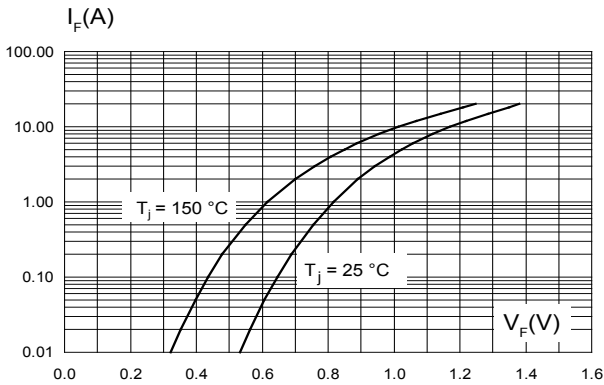

Figure 4. Forward voltage drop versus forward current (maximum values)

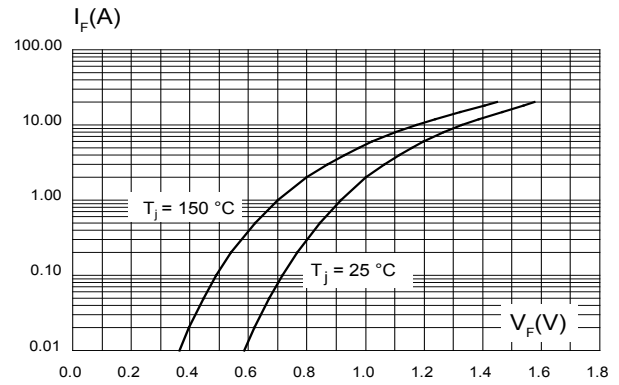

Figure 5. Relative variation of thermal impedance junction to lead versus pulse duration (SMB)

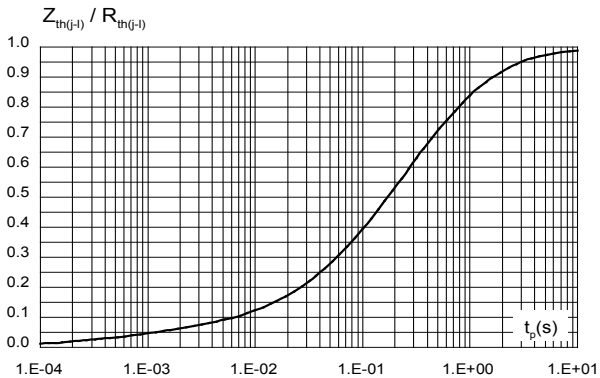

Figure 6. Junction capacitance versus reverse voltage applied (typical values)

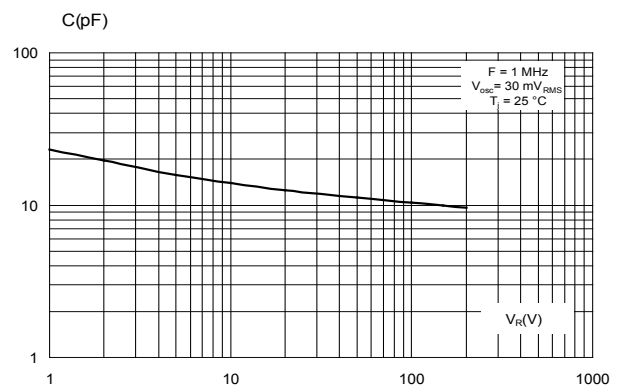

Figure 7. Reverse recovery charges versus di_F/dt (typical values)

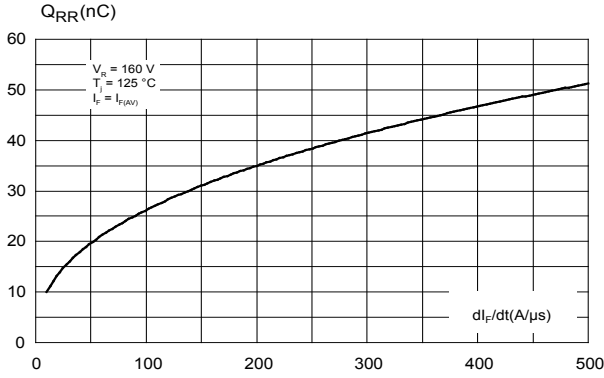

Figure 8. Reverse recovery time versus di_F/dt (typical values)

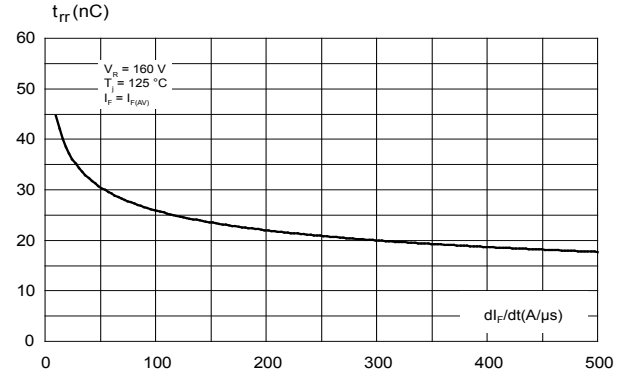

Figure 9. Peak reverse recovery current versus di_F/dt (typical values)

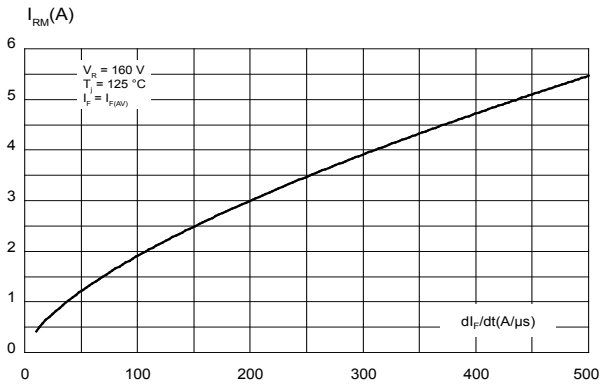

Figure 10. Relative variations of dynamic parameters versus junction temperature

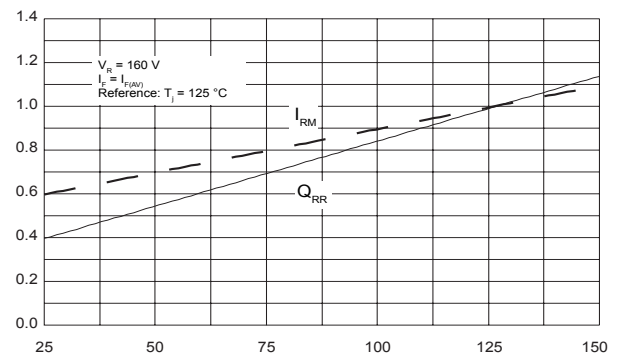
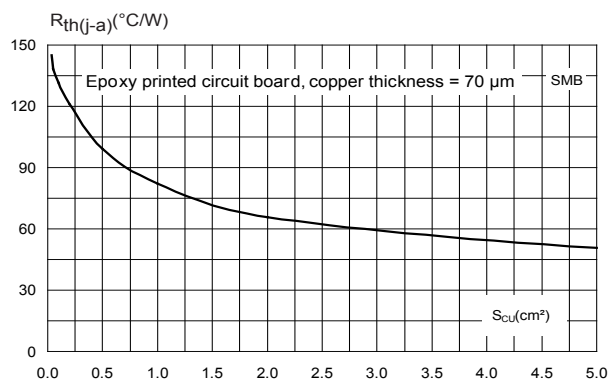

Figure 11. Thermal resistance junction to ambient versus copper surface under each lead (typical values)



2 Package information

In order to meet environmental requirements, ST offers these devices in different grades of **ECOPACK** packages, depending on their level of environmental compliance. ECOPACK specifications, grade definitions and product status are available at: www.st.com. ECOPACK is an ST trademark.

2.1 SMB package information

- Epoxy meets UL94, V0
- Lead-free package

Figure 12. SMB package outline

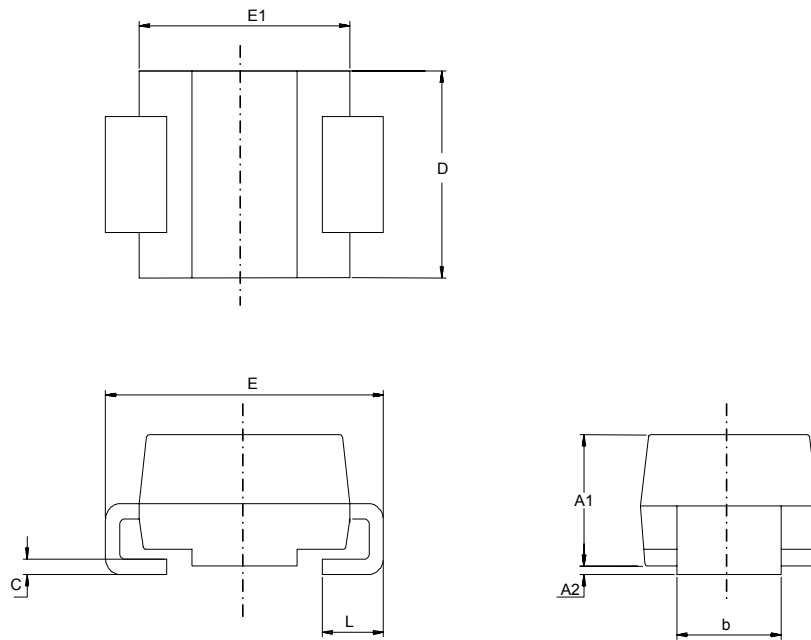
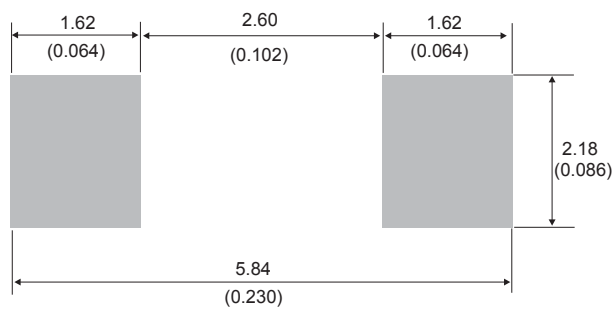

Table 5. SMB package mechanical data

Ref.	Dimensions			
	Millimeters		Inches (for reference only)	
	Min.	Max.	Min.	Max.
A1	1.90	2.45	0.074	0.097
A2	0.05	0.20	0.001	0.008
b	1.95	2.20	0.076	0.087
c	0.15	0.40	0.005	0.016
D	3.30	3.95	0.129	0.156
E	5.10	5.60	0.200	0.221
E1	4.05	4.60	0.159	0.182
L	0.75	1.50	0.029	0.060

Figure 13. SMB recommended footprint



3 Ordering information

Figure 14. Ordering information scheme

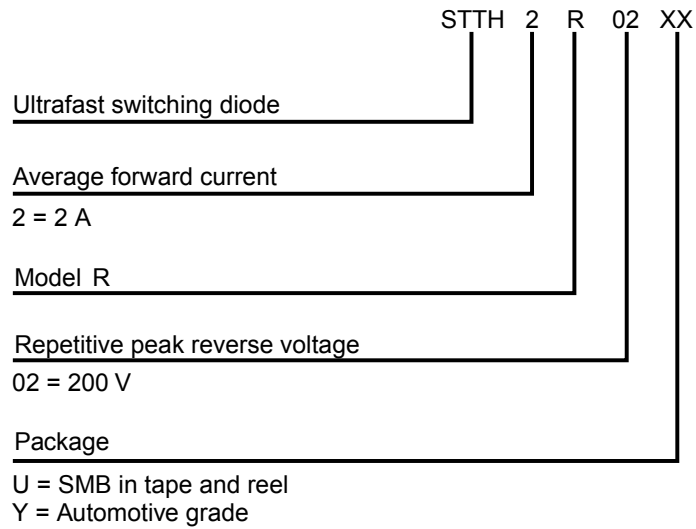

Table 6. Ordering information

Order code	Marking	Package	Weight	Base qty.	Delivery mode
STTH2R02UY	R2UY	SMB	0.110 g	2500	Tape and reel

Revision history

Table 7. Document revision history

Date	Revision	Changes
20-Oct-2010	1	First issue.
02-Feb-2017	2	Updated Figure 4: "Relative variation of thermal impedance junction to case versus pulse duration".
10-Jul-2020	3	Updated Section 1.1 Characteristics (curves) and added Section Applications . Minor text changes.

IMPORTANT NOTICE – PLEASE READ CAREFULLY

STMicroelectronics NV and its subsidiaries (“ST”) reserve the right to make changes, corrections, enhancements, modifications, and improvements to ST products and/or to this document at any time without notice. Purchasers should obtain the latest relevant information on ST products before placing orders. ST products are sold pursuant to ST’s terms and conditions of sale in place at the time of order acknowledgement.

Purchasers are solely responsible for the choice, selection, and use of ST products and ST assumes no liability for application assistance or the design of Purchasers’ products.

No license, express or implied, to any intellectual property right is granted by ST herein.

Resale of ST products with provisions different from the information set forth herein shall void any warranty granted by ST for such product.

ST and the ST logo are trademarks of ST. For additional information about ST trademarks, please refer to www.st.com/trademarks. All other product or service names are the property of their respective owners.

Information in this document supersedes and replaces information previously supplied in any prior versions of this document.

© 2020 STMicroelectronics – All rights reserved

Mouser Electronics

Authorized Distributor

Click to View Pricing, Inventory, Delivery & Lifecycle Information:

[STMicroelectronics:](#)

[STTH2R02UY](#)