



# STD26NF10

N-channel 100V - 0.033Ω - 25A - DPAK  
Low gate charge STripFET™ II Power MOSFET

## Features

Type	V <sub>DSS</sub>	R <sub>DS(on)</sub>	I <sub>D</sub>
STD26NF10	100V	< 0.038Ω	25A

- Exceptional dv/dt capability
- Application oriented characterization
- 100% avalanche tested
- Application oriented characterization

## Description

This Power MOSFET series realized with STMicroelectronics unique STripFET process has specifically been designed to minimize input capacitance and gate charge. It is intended for any application with low gate charge drive requirements.

## Applications

- Switching application
  - Automotive

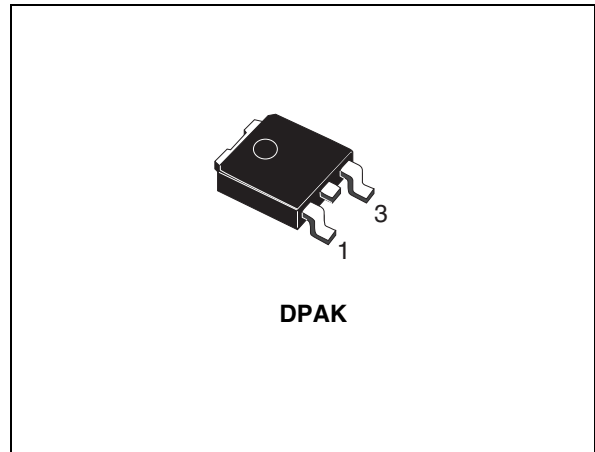

## Internal schematic diagram

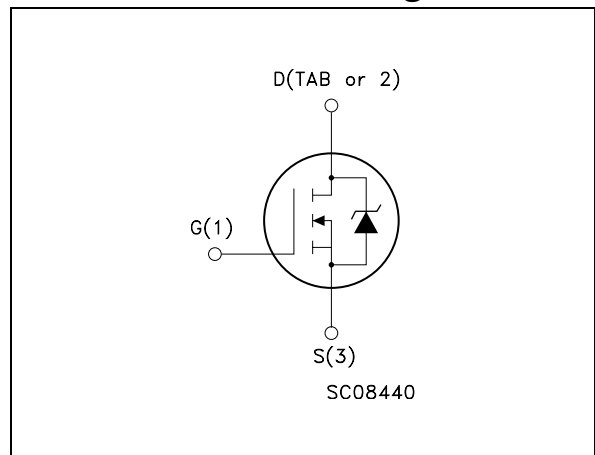

## Order code

Part number	Marking	Package	Packaging
STD26NF10	D26NF10	DPAK	Tape & reel

# Contents

<b>1</b>	<b>Electrical ratings</b> .....	<b>3</b>
<b>2</b>	<b>Electrical characteristics</b> .....	<b>4</b>
	2.1 Electrical characteristics (curves) .....	6
<b>3</b>	<b>Test circuit</b> .....	<b>8</b>
<b>4</b>	<b>Package mechanical data</b> .....	<b>9</b>
<b>5</b>	<b>Packing mechanical data</b> .....	<b>11</b>
<b>6</b>	<b>Revision history</b> .....	<b>12</b>

# 1 Electrical ratings

**Table 1. Absolute maximum ratings**

Symbol	Parameter	Value	Unit
$V_{DS}$	Drain-source voltage ( $V_{GS} = 0$ )	100	V
$V_{DGR}$	Drain-gate voltage ( $R_{GS} = 20\text{ k}\Omega$ )	100	V
$V_{GS}$	Gate- source voltage	$\pm 20$	V
$I_D^{(1)}$	Drain current (continuous) at $T_C = 25^\circ\text{C}$	25	A
$I_D$	Drain current (continuous) at $T_C = 100^\circ\text{C}$	21	A
$I_{DM}^{(2)}$	Drain current (pulsed)	100	A
$P_{tot}$	Total dissipation at $T_C = 25^\circ\text{C}$	100	W
	Derating Factor	0.67	W/°C
$dv/dt^{(3)}$	Peak diode recovery avalanche energy	13	V/ns
$E_{AS}^{(4)}$	Single pulse avalanche energy	480	mJ
$T_{stg}$	Storage temperature	-55 to 175	°C
$T_j$	Max. operating junction temperature		

1. Current limited by package
2. Pulse width limited by safe operating area.
3.  $I_{SD} \leq 35\text{A}$ ,  $di/dt \leq 300\text{A}/\mu\text{s}$ ,  $V_{DD} = V_{(BR)DSS}$ ,  $T_j \leq T_{JMAX}$
4. Starting  $T_j = 25^\circ\text{C}$ ,  $I_D = 12.5\text{A}$ ,  $V_{DD} = 50\text{V}$

**Table 2. Thermal data**

$R_{thj-case}$	Thermal resistance junction-case max	1.5	°C/W
$R_{thj-amb}$	Thermal resistance junction-to ambient max	100	°C/W
$T_J$	Maximum lead temperature for soldering purpose	300	°C

## 2 Electrical characteristics

( $T_{CASE}=25^{\circ}C$  unless otherwise specified)

**Table 3. On/off states**

Symbol	Parameter	Test conditions	Min.	Typ.	Max.	Unit
$V_{(BR)DSS}$	Drain-source breakdown voltage	$I_D = 250\mu A, V_{GS} = 0$	100			V
$I_{DSS}$	Zero gate voltage drain current ( $V_{GS} = 0$ )	$V_{DS} = \text{Max rating}$ $V_{DS} = \text{Max rating},$ $T_C = 125^{\circ}C$			1 10	$\mu A$ $\mu A$
$I_{GSS}$	Gate-body leakage current ( $V_{DS} = 0$ )	$V_{GS} = \pm 20V$			$\pm 100$	nA
$V_{GS(th)}$	Gate threshold voltage	$V_{DS} = V_{GS}, I_D = 250\mu A$	2	3	4	V
$R_{DS(on)}$	Static drain-source on resistance	$V_{GS} = 10V, I_D = 12.5A$		0.033	0.038	$\Omega$

**Table 4. Dynamic**

Symbol	Parameter	Test conditions	Min.	Typ.	Max.	Unit
$g_{fs}^{(1)}$	Forward transconductance	$V_{DS} = 15V, I_D = 12.5A$		20		S
$C_{iss}$ $C_{oss}$ $C_{rss}$	Input capacitance Output capacitance Reverse transfer capacitance	$V_{DS} = 25V, f = 1MHz,$ $V_{GS} = 0$		1550 220 95		pF pF pF
$t_{d(on)}$ $t_r$ $t_{d(off)}$ $t_f$	Turn-on delay time Rise time Turn-off delay time Fall time	$V_{DD} = 50V, I_D = 12.5A$ $R_G = 4.7\Omega, V_{GS} = 10V$ (see <a href="#">Figure 12</a> )		17 60 60 15		ns ns ns ns
$Q_g$ $Q_{gs}$ $Q_{gd}$	Total gate charge Gate-source charge Gate-drain charge	$V_{DD} = 80V, I_D = 12.5A,$ $V_{GS} = 10V, R_G = 4.7\Omega$ (see <a href="#">Figure 13</a> )		55 12 20		nC nC nC

1. Pulsed: Pulse duration = 300  $\mu s$ , duty cycle 1.5%.

**Table 5. Source drain diode**

Symbol	Parameter	Test conditions	Min.	Typ.	Max.	Unit
$I_{SD}$ $I_{SDM}^{(1)}$	Source-drain current Source-drain current (pulsed)				25 100	A A
$V_{SD}^{(2)}$	Forward on voltage	$I_{SD} = 25A, V_{GS} = 0$			1.5	V
$t_{rr}$ $Q_{rr}$ $I_{RRM}$	Reverse recovery time Reverse recovery charge Reverse recovery current	$I_{SD} = 25A, di/dt = 100A/\mu s,$ $V_{DD} = 50V, T_j = 150^\circ C$ (see <a href="#">Figure 14</a> )		88 317 7.2		ns nC A

1. Pulse width limited by safe operating area.
2. Pulsed: Pulse duration = 300  $\mu s$ , duty cycle 1.5%

## 2.1 Electrical characteristics (curves)

Figure 1. Safe operating area

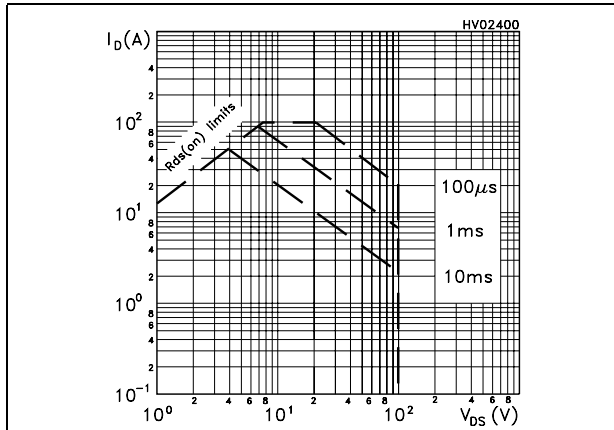

Figure 2. Thermal impedance



Figure 3. Output characteristics

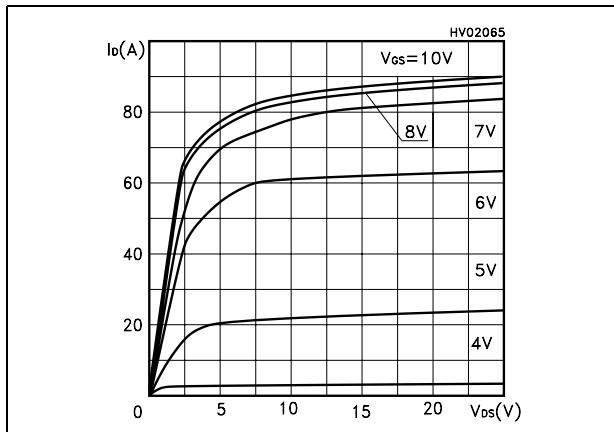

Figure 4. Transfer characteristics

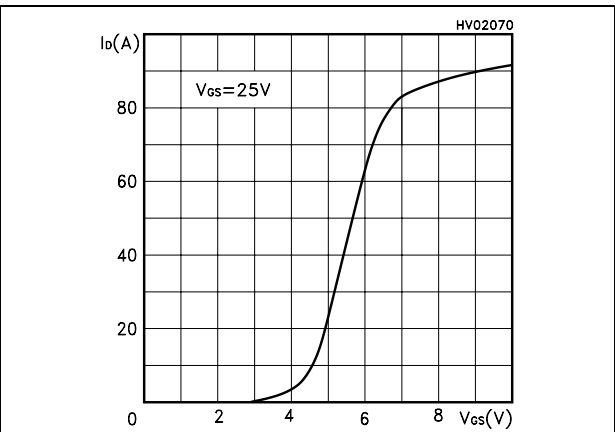

Figure 5. Transconductance

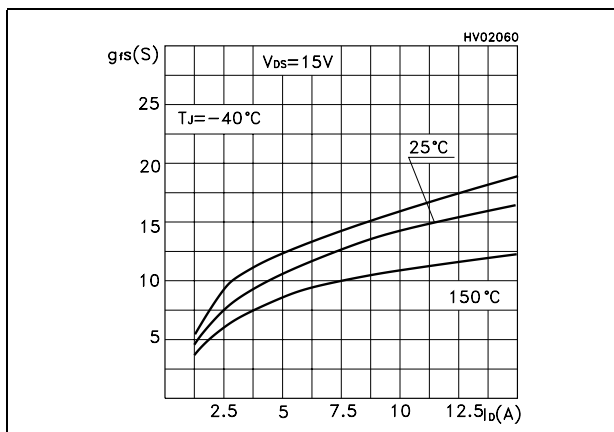

Figure 6. Static drain-source on resistance

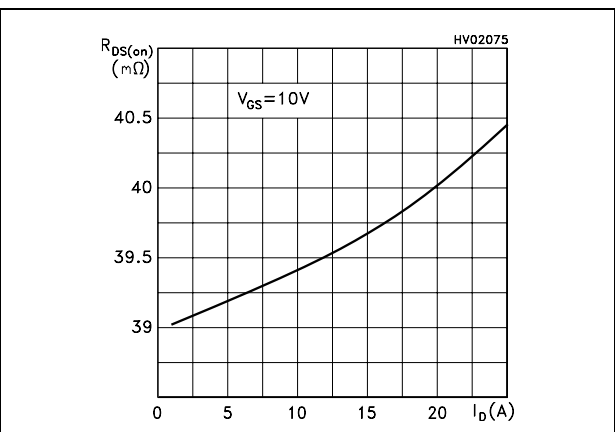

Figure 7. Gate charge vs. gate-source voltage Figure 8. Capacitance variations

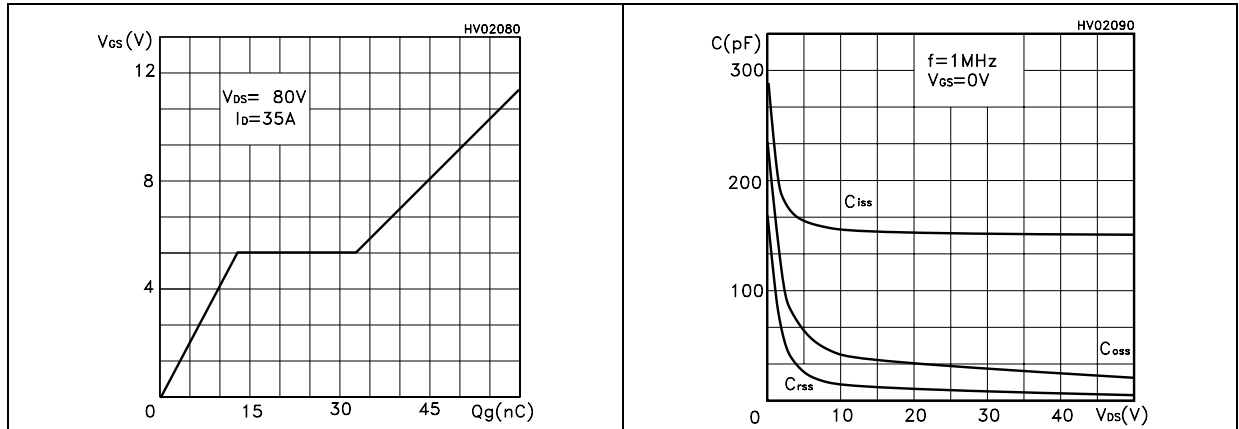

Figure 9. Normalized gate threshold voltage vs. temperature Figure 10. Normalized on resistance vs. temperature

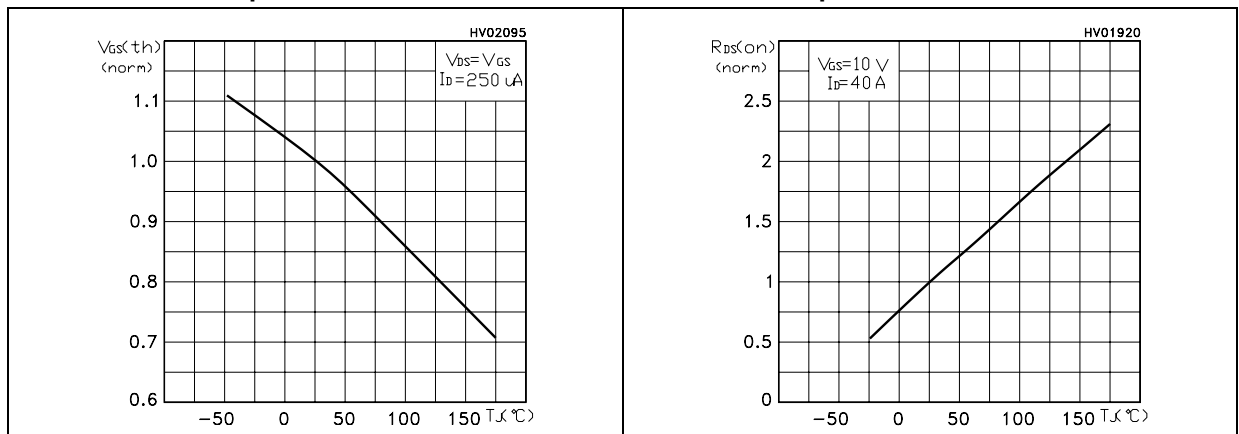
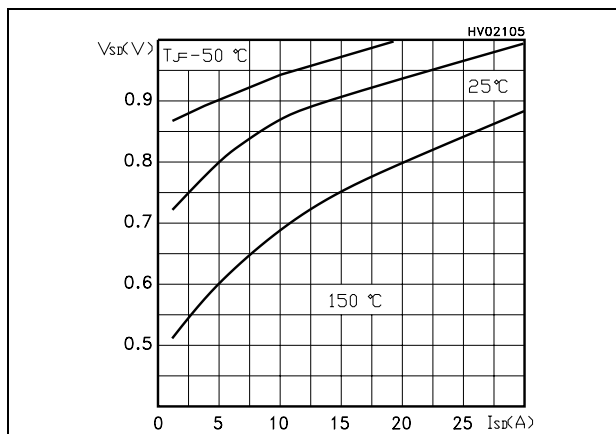

Figure 11. Source-drain diode forward characteristics



### 3 Test circuit

Figure 12. Switching times test circuit for resistive load



Figure 13. Gate charge test circuit

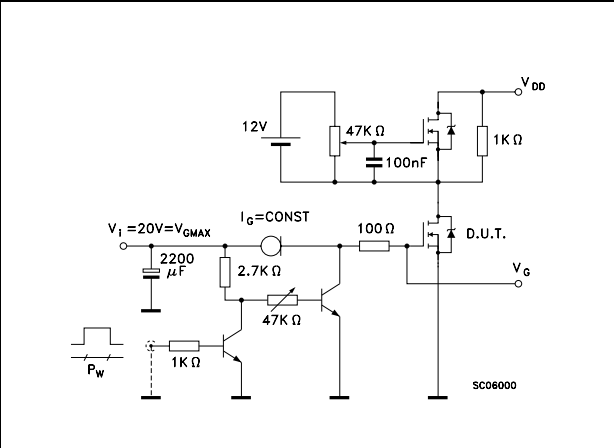

Figure 14. Test circuit for inductive load switching and diode recovery times



Figure 15. Unclamped Inductive load test circuit



Figure 16. Unclamped inductive waveform

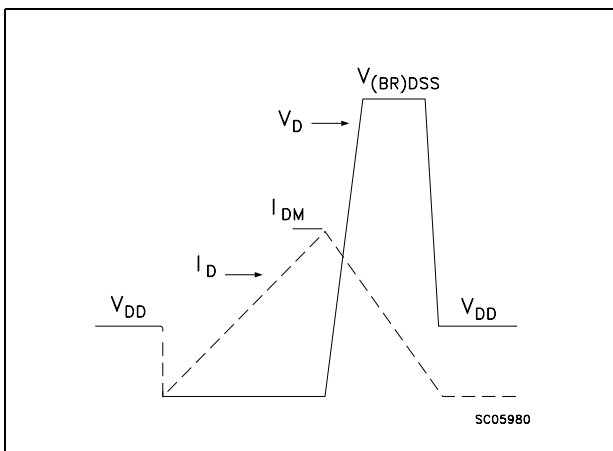
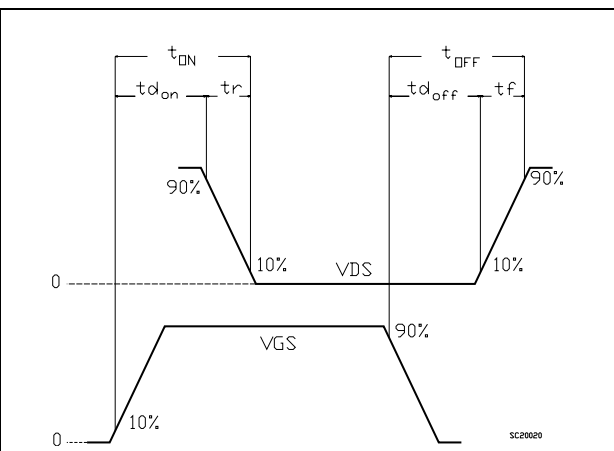

Figure 17. Switching time waveform





## 4 Package mechanical data

In order to meet environmental requirements, ST offers these devices in ECOPACK® packages. These packages have a Lead-free second level interconnect. The category of second level interconnect is marked on the package and on the inner box label, in compliance with JEDEC Standard JESD97. The maximum ratings related to soldering conditions are also marked on the inner box label. ECOPACK is an ST trademark. ECOPACK specifications are available at: [www.st.com](http://www.st.com)

**DPAK MECHANICAL DATA**

DIM.	mm.			inch		
	MIN.	TYP.	MAX.	MIN.	TYP.	MAX.
A	2.2		2.4	0.086		0.094
A1	0.9		1.1	0.035		0.043
A2	0.03		0.23	0.001		0.009
B	0.64		0.9	0.025		0.035
b4	5.2		5.4	0.204		0.212
C	0.45		0.6	0.017		0.023
C2	0.48		0.6	0.019		0.023
D	6		6.2	0.236		0.244
D1		5.1			0.200	
E	6.4		6.6	0.252		0.260
E1		4.7			0.185	
e		2.28			0.090	
e1	4.4		4.6	0.173		0.181
H	9.35		10.1	0.368		0.397
L	1			0.039		
(L1)		2.8			0.110	
L2		0.8			0.031	
L4	0.6		1	0.023		0.039
R		0.2			0.008	
V2	0°		8°	0°		8°

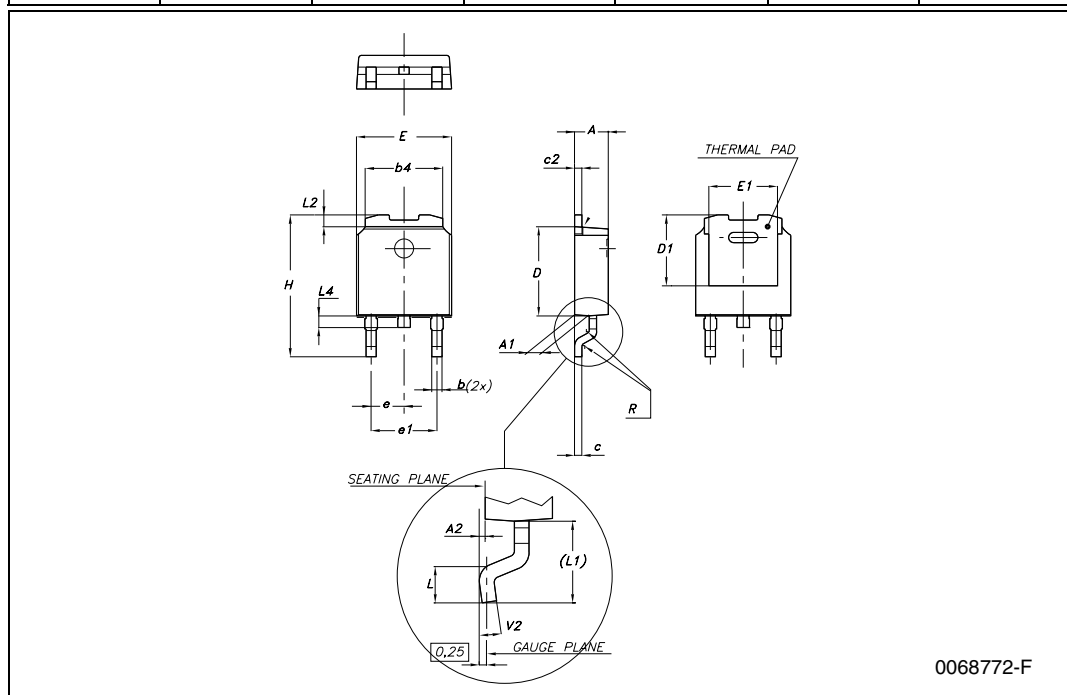

0068772-F

# 5 Packing mechanical data

## DPAK FOOTPRINT

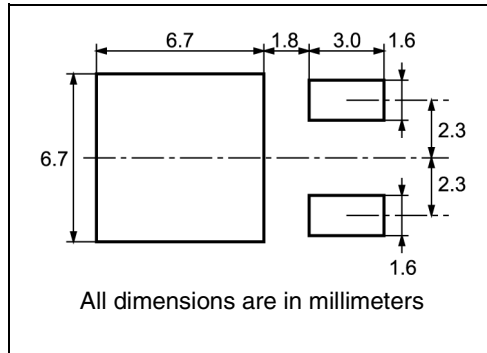

## TAPE AND REEL SHIPMENT

40 mm min. Access hole at slot location

Full radius

Tape slot in core for tape start 2.5mm min. width

G measured at hub

DIM.	mm		inch	
	MIN.	MAX.	MIN.	MAX.
A		330		12.992
B	1.5		0.059	
C	12.8	13.2	0.504	0.520
D	20.2		0.795	
G	16.4	18.4	0.645	0.724
N	50		1.968	
T		22.4		0.881

BASE QTY	BULK QTY
2500	2500

DIM.	mm		inch	
	MIN.	MAX.	MIN.	MAX.
A0	6.8	7	0.267	0.275
B0	10.4	10.6	0.409	0.417
B1		12.1		0.476
D	1.5	1.6	0.059	0.063
D1	1.5		0.059	
E	1.65	1.85	0.065	0.073
F	7.4	7.6	0.291	0.299
K0	2.55	2.75	0.100	0.108
P0	3.9	4.1	0.153	0.161
P1	7.9	8.1	0.311	0.319
P2	1.9	2.1	0.075	0.082
R	40		1.574	
W	15.7	16.3	0.618	0.641

10 pitches cumulative tolerance on tape +/- 0.2 mm

User Direction of Feed

Center line of cavity

For machine ref. only including draft and radii concentric around B0

FEED DIRECTION

Bending radius R min.

## 6 Revision history

**Table 6. Revision history**

Date	Revision	Changes
20-Apr-2007	1	First release

**Please Read Carefully:**

Information in this document is provided solely in connection with ST products. STMicroelectronics NV and its subsidiaries ("ST") reserve the right to make changes, corrections, modifications or improvements, to this document, and the products and services described herein at any time, without notice.

All ST products are sold pursuant to ST's terms and conditions of sale.

Purchasers are solely responsible for the choice, selection and use of the ST products and services described herein, and ST assumes no liability whatsoever relating to the choice, selection or use of the ST products and services described herein.

No license, express or implied, by estoppel or otherwise, to any intellectual property rights is granted under this document. If any part of this document refers to any third party products or services it shall not be deemed a license grant by ST for the use of such third party products or services, or any intellectual property contained therein or considered as a warranty covering the use in any manner whatsoever of such third party products or services or any intellectual property contained therein.

**UNLESS OTHERWISE SET FORTH IN ST'S TERMS AND CONDITIONS OF SALE ST DISCLAIMS ANY EXPRESS OR IMPLIED WARRANTY WITH RESPECT TO THE USE AND/OR SALE OF ST PRODUCTS INCLUDING WITHOUT LIMITATION IMPLIED WARRANTIES OF MERCHANTABILITY, FITNESS FOR A PARTICULAR PURPOSE (AND THEIR EQUIVALENTS UNDER THE LAWS OF ANY JURISDICTION), OR INFRINGEMENT OF ANY PATENT, COPYRIGHT OR OTHER INTELLECTUAL PROPERTY RIGHT.**

**UNLESS EXPRESSLY APPROVED IN WRITING BY AN AUTHORIZED ST REPRESENTATIVE, ST PRODUCTS ARE NOT RECOMMENDED, AUTHORIZED OR WARRANTED FOR USE IN MILITARY, AIR CRAFT, SPACE, LIFE SAVING, OR LIFE SUSTAINING APPLICATIONS, NOR IN PRODUCTS OR SYSTEMS WHERE FAILURE OR MALFUNCTION MAY RESULT IN PERSONAL INJURY, DEATH, OR SEVERE PROPERTY OR ENVIRONMENTAL DAMAGE. ST PRODUCTS WHICH ARE NOT SPECIFIED AS "AUTOMOTIVE GRADE" MAY ONLY BE USED IN AUTOMOTIVE APPLICATIONS AT USER'S OWN RISK.**

Resale of ST products with provisions different from the statements and/or technical features set forth in this document shall immediately void any warranty granted by ST for the ST product or service described herein and shall not create or extend in any manner whatsoever, any liability of ST.

ST and the ST logo are trademarks or registered trademarks of ST in various countries.

Information in this document supersedes and replaces all information previously supplied.

The ST logo is a registered trademark of STMicroelectronics. All other names are the property of their respective owners.

© 2007 STMicroelectronics - All rights reserved

STMicroelectronics group of companies

Australia - Belgium - Brazil - Canada - China - Czech Republic - Finland - France - Germany - Hong Kong - India - Israel - Italy - Japan - Malaysia - Malta - Morocco - Singapore - Spain - Sweden - Switzerland - United Kingdom - United States of America

[www.st.com](http://www.st.com)

# Mouser Electronics

Authorized Distributor

Click to View Pricing, Inventory, Delivery & Lifecycle Information:

[STMicroelectronics:](#)

[STD26NF10](#)