

Compensated Choke, 1-phase

new



See below:

**Approvals and Compliances**

**Description**

- Current compensated 1-phase choke
- Nanocrystalline cores
- THT-terminals
- Flange for mounting onto printed circuit board

**Unique Selling Proposition**

- Very high inductance
- Compact design with a small footprint
- Open design optimizes heat dissipation
- Optional customized versions

**Applications**

- Switching power supplies
- Medical equipment
- Laboratory equipment
- Test equipment
- Frequency inverters

**Weblinks**

[pdf data sheet](#), [html datasheet](#), [General Product Information](#), [Approvals](#), [Distributor-Stock-Check](#), [Detailed request for product](#), [SPICE Library](#), [Landing Page](#)

**Technical Data**

Rated voltage	300 VAC	Test Voltage	1900 VDC, 2 sec, winding to winding
	450 VDC	Climatic Category	40/100/21 acc. to IEC 60068-1
Rated Current	0.5 - 10A @ Ta 50 °C	Allowable Operation Temp.	-40 °C to 100 °C
Rated inductance	0.9 - 180mH, Tol. -30% +50%		
Power Operating Frequency	0 - 400Hz		
Terminal Type	THT		
Weight	8.5 - 9g		
Material	UL 94V-0 Plastic		

**Approvals and Compliances**



Detailed information on product approvals, code requirements, usage instructions and detailed test conditions can be looked up in [Details about Approvals](#)

SCHURTER products are designed for use in industrial environments. They have approvals from independent testing bodies according to national and international standards. Products with specific characteristics and requirements such as required in the automotive sector according to IATF 16949, medical technology according to ISO 13485 or in the aerospace industry can be offered exclusively with customer-specific, individual agreements by SCHURTER.

**Approvals**

The approval mark is used by the testing authorities to certify compliance with the safety requirements placed on electronic products.

Approval Reference Type: DKCV

Approval Logo	Certificates	Certification Body	Description
	<a href="#">VDE Approvals</a>	VDE	VDE Certificate Number: 40059622
	<a href="#">UL Approvals</a>	UL	UR File Number: E495089





**Application standards**

Application standards where the product can be used

Organization	Design	Standard	Description
	Suitable for applications acc.	IEC/UL 62368-1	Audio/video, information and communication technology equipment - Part 1: Safety requirements

## Compliances

The product complies with following Guide Lines

Identification	Details	Initiator	Description
	<a href="#">CE declaration of conformity</a>	SCHURTER AG	The CE marking declares that the product complies with the applicable requirements laid down in the harmonisation of Community legislation on its affixing in accordance with EU Regulation 765/2008.
	<a href="#">UKCA declaration of conformity</a>	SCHURTER AG	The UKCA marking declares that the product complies with the applicable requirements laid down in the British Amendment of Regulation (EC) 765/2008.
	RoHS	SCHURTER AG	Directive RoHS 2011/65/EU, Amendment (EU) 2015/863
	China RoHS	SCHURTER AG	The law SJ / T 11363-2006 (China RoHS) has been in force since 1 March 2007. It is similar to the EU directive RoHS.
	REACH	SCHURTER AG	On 1 June 2007, Regulation (EC) No 1907/2006 on the Registration, Evaluation, Authorization and Restriction of Chemicals 1 (abbreviated as "REACH") entered into force.

## Dimensions [mm]

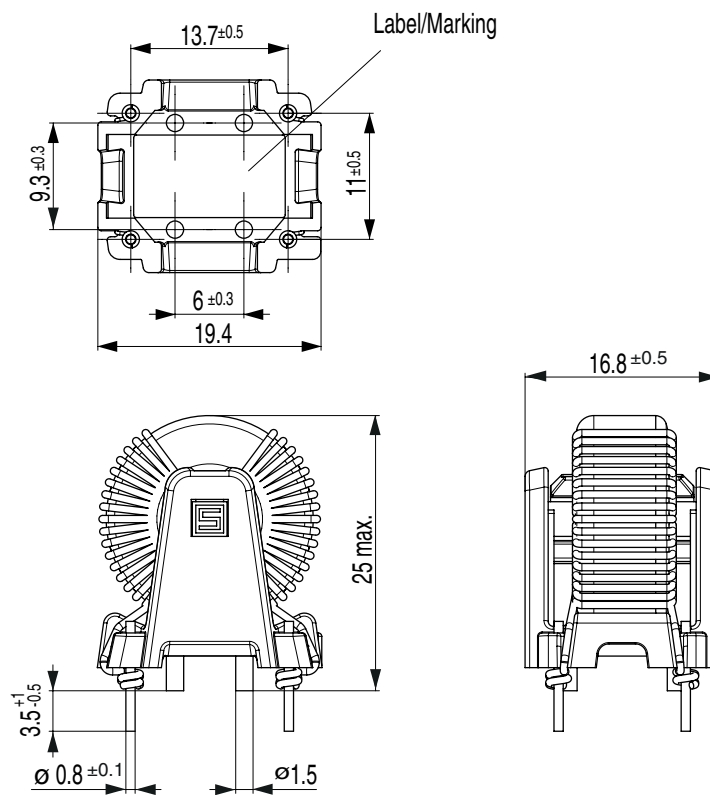

## Diagrams

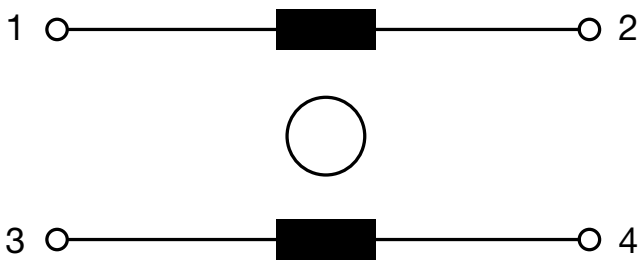

1 phase

Impedance curves

DKCV-1 / 0.5 A

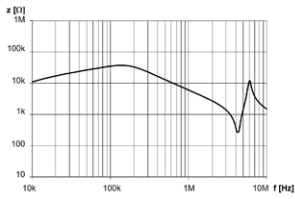

DKCV-1 / 1 A

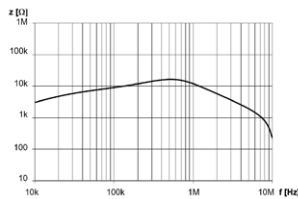

DKCV-1 / 2 A

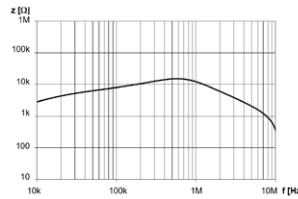

DKCV-1 / 3 A

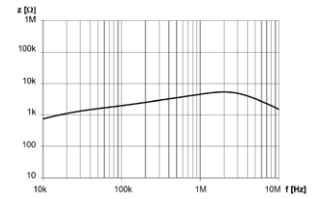

DKCV-1 / 4 A

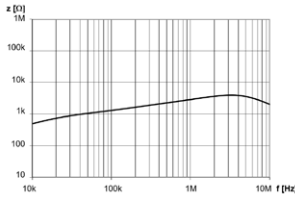

DKCV-1 / 6 A

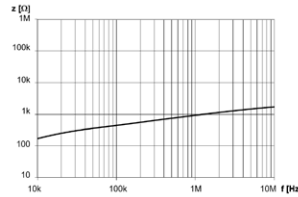

DKCV-1 / 8 A

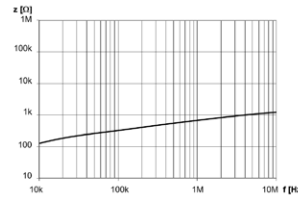

DKCV-1 / 10 A

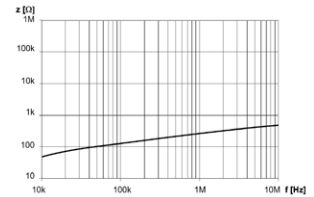

All Variants

$I_n$ [A]	$L_n$ [mH]	$R_{cu}$ [mΩ]	Power Dissipation [W]	$f_{RES}$ [MHz]	Copper $\phi$ [mm]	Weight [g]	Packaging unit [PCS]	Order Number
0.5	180	430	0.22	0.15	0.3	8.5 g	180	3-137-414
1	55	155	0.31	0.53	0.375	8.5 g	180	3-137-415
2	45	122	0.98	0.56	0.4	8.5 g	180	3-137-416
3	12	23.7	0.43	2.05	0.63	9 g	180	3-137-417
4	7.8	15.7	0.5	3.34	0.71	9 g	180	3-137-418
6	2.7	5.7	0.41	19.9	0.9	9 g	180	3-137-419
8	1.9	4	0.51	24.7	1	9 g	180	3-137-420
10	0.9	1.85	0.37	50.3	1.25	9 g	180	3-137-421

Availability for all products can be searched real-time: <https://www.schurter.com/en/info-center/support-tools/stock-check-distributors>

# Mouser Electronics

Authorized Distributor

Click to View Pricing, Inventory, Delivery & Lifecycle Information:

[Schurter:](#)

[3-137-419](#) [3-137-420](#) [3-137-416](#) [3-137-418](#) [3-137-414](#) [3-137-421](#) [3-137-415](#) [3-137-417](#)