

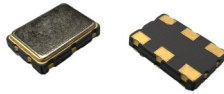

PLETRONICS *PRONTO*™ QP77L SERIES 2.5V PECL Clock Oscillator



QP77L
7.0 x 5.0 x 1.45 mm
LCC Ceramic Package

Features

- Quartz crystal controlled configurable Precision Square Wave Oscillator
- PECL Output
- Enable/Disable Function on pad 1 (optional pad 2)
- Low Jitter
- 2.5V nominal Supply Voltage
- 10MHz - 1500MHz nominal frequency

Applications

Driving A/Ds, D/As, FPGAs
Fibre Channel
Ethernet, GbE, SynchE
Medical
Storage Area Networking
COTS
Telecom
PON

Electrical Characteristics

Parameter	Min	Typ	Max	Unit	Condition
Frequency Range ²	10	-	1500	MHz	
Frequency Stability ² ± 20 = 20* , ± 25 = 44 , ± 50 = 45	±20	-	±50	ppm	Includes supply voltage change, load change, aging for 1 year at 25°C ± 2°C, shock, vibration, temperature range. *Aging excluded
Operating Temperature Range ²	-10 -20 -40	-	+70 +70 +85	°C	Standard range Extended range C option Extended range E option
Supply Voltage ^{1,2} V _{CC}	2.375	2.5	2.625	V	
Supply Current I _{CC}	-	-	50	mA	
Output Waveform	PECL				
Output High Level V _{OH}	V _{CC} -1.03	-	V _{CC} -0.6	V	Referenced to Ground
Output Low Level V _{OL}	V _{CC} -1.85	-	V _{CC} -1.6	V	Referenced to Ground
Output T _{RISE} and T _{FALL}	-	-	1.0	ns	V _{th} is 10% and 90% of output swing
Startup Time	-	-	10	ms	Time for output to reach specified frequency
Duty Cycle	45	-	55	%	At output crossing point
V _{DISABLE} V _{IL}	-	-	0.3*V _{CC}	V	Referenced to Ground
V _{ENABLE} V _{IH}	0.7*V _{CC}	-	-		
Enable Time	-	-	200	ns	<50MHz
	-	-	100	ns	≥ 50MHz
Disable Time	-	-	50	ns	Time for output to reach a high Z state
Standby Current	-	18	-	mA	Pad 1 low, device disabled
Phase Noise	10 Hz 100 Hz 1 kHz 1 MHz 20 MHz	-	-66 -96 -112 -136 -154	-	dBc/Hz Precision Developed Frequencies: 100, 106.25, 120, 156.25, 162.5, 175, 187.5, 200, 212.5, 312.5MHz 25°C ± 2°C / 156.250 MHz
Jitter	-	0.6	-	ps rms	
Phase Noise	10 Hz 100 Hz 1 kHz 1 MHz 20 MHz	-	-51 -88 -108 -135 -151	-	dBc/Hz All Other Frequencies 25°C ± 2°C / 150.0 MHz
Jitter	-	2.4	-	ps rms	
Aging	-	-	±3.0	ppm	First year at 25°C
Storage Temperature Range	-55	-	+125	°C	

Notes: Specifications with Pad 1 E/D open circuit

¹ Place an appropriate power supply bypass capacitor next to device for correct operation

² Specified by part number



PLETRONICS *PRONTO*™ QP77L SERIES 2.5V PECL Clock Oscillator

Part Number*

Series Model	Frequency Stability		Operating Temperature Range	Supply Voltage V _{CC}	Frequency in MHz
QP77	45	L	E	W	- 125.0M
	45 = ± 50 ppm (STD) 44 = ± 25 ppm 20 = ± 20 ppm		Blank = -10 to +70°C (STD) C = -20 to +70°C E = -40 to +85°C	W = 2.5V ± 5%	10-1500MHz

*If Enable/Disable on Pin 2 a custom P/N will be assigned

Device Marking

PRONTO
FF.FFFF
• **YMDxxx**

PRONTO = Pletronics Model
FF.FFFF = Frequency, max 7 digits includes decimal. Integer freq, i.e., 50MHz, to significant decimal (50.0)
YMD = Date Code, Year Month Day (see below)
xxx = internal factory codes

Note: Specifications such as frequency stability, supply voltage and operating temperature range, etc. are not identified from marking. External packaging labels and packing list will correctly identify the ordered Pletronics part number.

Codes for Date Code YMD (Year Month Day)





Code	3	4	5	6	7	Code	A	B	C	D	E	F	G	H	J	K	L	M
Year	2023	2024	2025	2026	2027	Month	JAN	FEB	MAR	APR	MAY	JUN	JUL	AUG	SEP	OCT	NOV	DEC

Code	1	2	3	4	5	6	7	8	9	A	B	C	D	E	F	G
Day	1	2	3	4	5	6	7	8	9	10	11	12	13	14	15	16
Code	H	J	K	L	M	N	P	R	T	U	V	W	X	Y	Z	
Day	17	18	19	20	21	22	23	24	25	26	27	28	29	30	31	

Package Labeling

P/N Label is 1" x 2.6" (25.4mm x 66.7mm)
Font is Courier New
Bar code is 39-Full ASCII

RoHS Label is 1" x 2.6" (25.4mm x 66.7mm)
Font is Arial

P/N: 
PLE Part Number
Customer P/N: 
12345678
Qty:  1000 **D/C**  2A1
MSL: 1

RoHS Compliant
2nd LvL Interconnect
Category=e4
Max Safe Temp=260C for 10s 2X Max

Pletronics Inc. certifies this device is in accordance with the RoHS and REACH directives.

Pletronics Inc. guarantees the device does not contain the following: Cadmium, Hexavalent Chromium, Lead, Mercury, PBBs, PBDE's
Weight of the Device: 0.16 grams
Moisture Sensitivity Level: 1 As defined in J-STD-020D
Second Level Interconnect code: e4



PLETRONICS *PRONTO*™ QP77L SERIES 2.5V PECL Clock Oscillator

Mechanical Dimensions

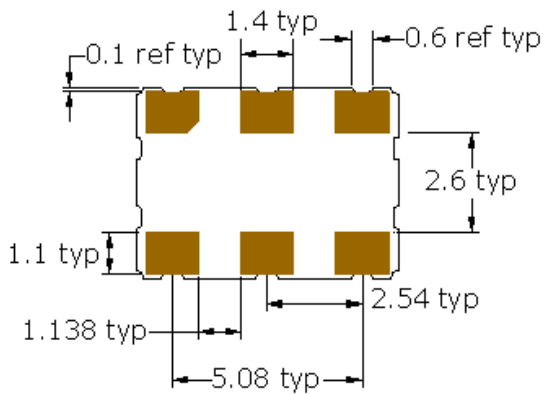
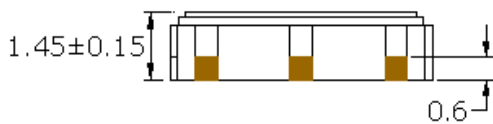
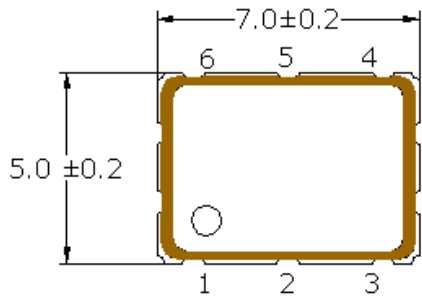

Dimensions in mm

Pad Connections

Pad	Function
1	Enable/Disable*
2	No Connect*
3	Ground
4	Output
5	Output N
6	Vcc

ENABLE/DISABLE	
Pad 1*	Output
V _{IH} /Open	Active
V _{IL} /Gnd	Disabled/Tristate

* = Optional Pad 2 for E/D

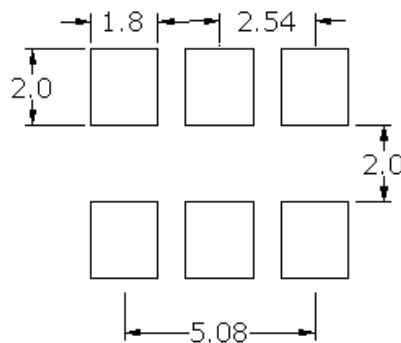

Solder pad layout

Pad Layout

Disclaimer: Recommended layout shown. Adjust layout as needed for individual process requirements.

Contacts (pads): Gold (0.3 to 1.0 μm) over Nickel (1.27 to 8.89 μm)

For Optimum Jitter Performance, Pletronics recommends:

- A ground plane under the device
- Do not route large transient signals (both current and voltage) under the device
- Do not place near a large magnetic field such as a high frequency switching power supply
- Do not place near piezoelectric buzzers or mechanical fans

Electrical Test /Load Circuit

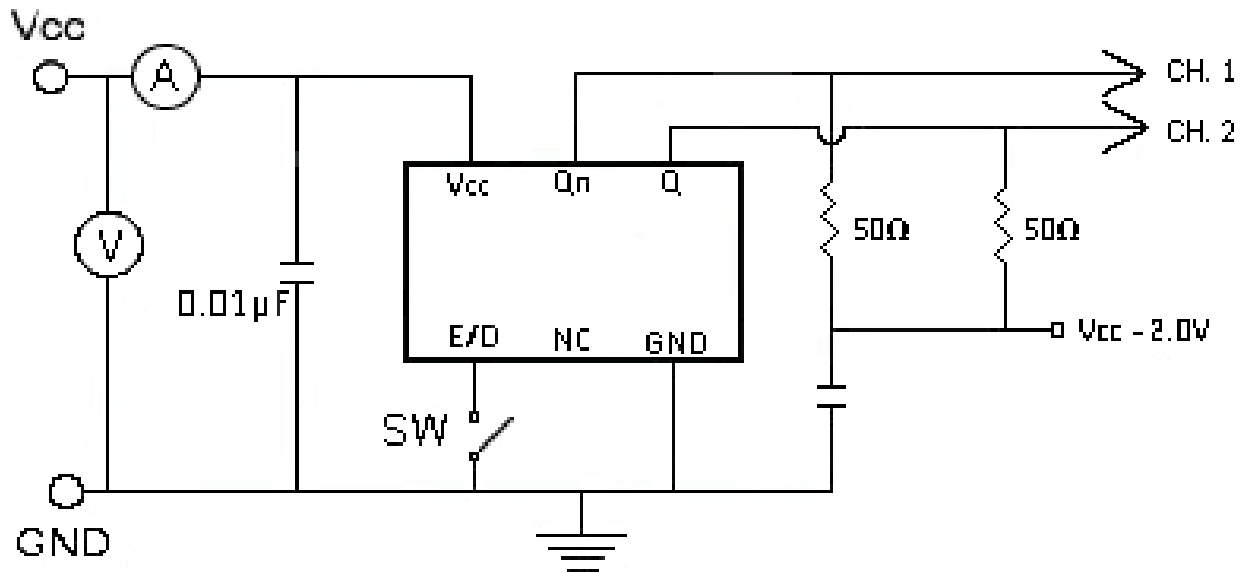

Test Waveform

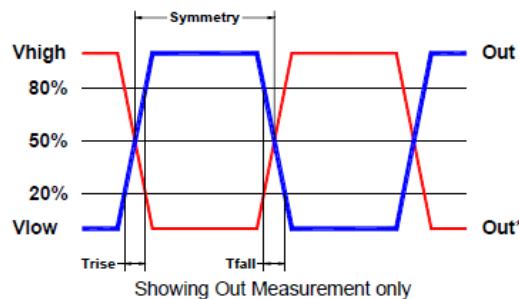

Environmental / ESD Ratings

Reliability: Environmental

Parameter	Condition
Mechanical Shock	MIL-STD-883, Method 2002, Condition B
Vibration	MIL-STD-883, Method 2007, Condition A
Solderability	IPC J-STD-002
Thermal Cycle	MIL-STD-883 Method 1010, Condition B

ESD Ratings

Model	Min. Voltage	Condition
Human Body Model	2000V	JESD22-A114
Charged Device Model	1000V	JESD22-C101
Machine Model	120V	JESD22-A115

Absolute Maximum Ratings

Parameter	Unit
V _{CC} Supply Voltage	-0.5V to +4.2V
V _i Input Voltage	-0.5V to V _{CC} + 0.5V
V _o Output Voltage	-0.5V to V _{CC} + 0.5V

Thermal Characteristics:

The maximum die or junction temperature is 125°C



PLETRONICS PRONTO™ QP77L SERIES 2.5V PECL Clock Oscillator

Reflow Cycle

Maximum Reflow Conditions in accordance with IPC/JEDEC J-STD-020C "Pb-free"

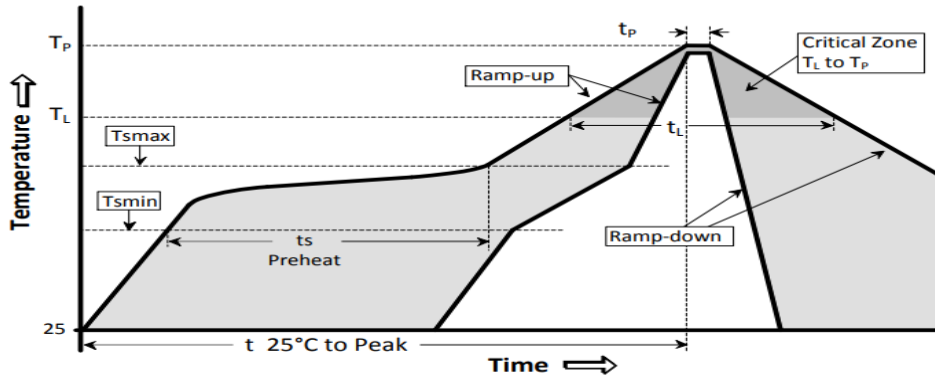

The part may be reflowed 2 times without degradation (typical for lead free processing).

Temperature Profile	Symbol	Condition	Unit
Average ramp-up rate	(T_{Smax} to T_P)	3°C / second max	°C / s
Ramp down Rate	T_{cool}	6°C / second max	°C / s
Time 25°C to Peak Temperature	$T_{to-peak}$	8 minutes max	min
Preheat			
Temperature min	T_{Smin}	150	°C
Temperature max	T_{Smax}	200	°C
Time T_{Smin} to T_{Smax}	t_s	60 – 180	sec
Soldering above liquidus			
Temperature liquidus	T_L	217	°C
Time above liquidus	t_L	60 – 150	sec
Peak temperature			
Peak Temperature	T_P	260	°C
Time within 5°C of peak temperature	t_p	20 – 40	sec

Tape and Reel

Tape and Reel available for quantities of 250 to 1000 per reel, cut tape for < 250. 16mm tape, 8mm pitch.

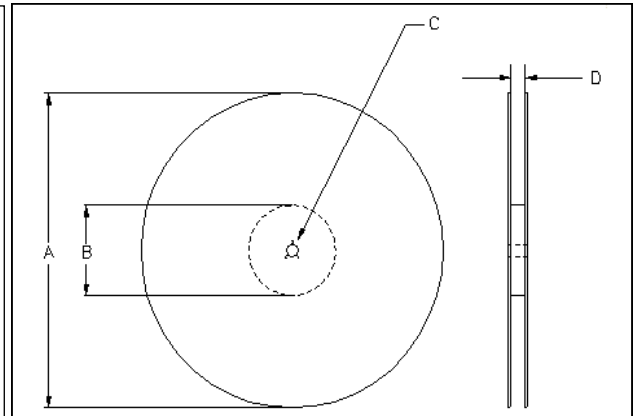
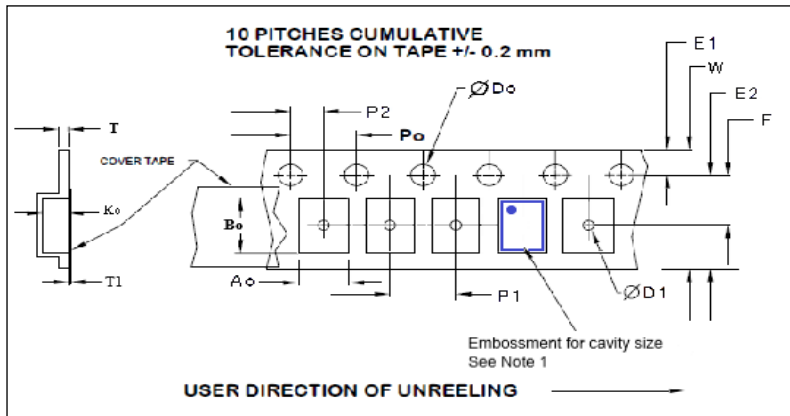

Tape Size	E2 typ	F	P1	W max	Ao	Bo	Ko
16mm	14.25	7.5 ±0.05	8.0 ±0.1	16.3	5.56±0.1	7.85±0.1	2.0±0.1

Dimensions in mm Drawing Not to scale
Note 1: Embossed cavity to conform to EIA-481-B

Reel Size	A		B		C	D
	Inches	mm	Inches	mm		
7	7.0	180	2.50	60	13.0 +0.5 -0.2	Tape size +0.4
13	13.0	330	4	100		+2.0 -0.0

Tape Size	Do	D1 typ	E1	Po	P2	T max	T1 max
16mm	1.5 +0.1 -0.0	1.5	1.75 ±0.1	4.0 ±0.1	2.0 ±0.1	0.3	0.1



PLETRONICS *PRONTO*[™] QP77L SERIES 2.5V PECL Clock Oscillator

Important Notice

Pletronics Incorporated (PLE) reserves the right to make corrections, improvements, modifications and other changes to this product at anytime. PLE reserves the right to discontinue any product or service without notice. Customers are responsible for obtaining the latest relevant information before placing orders and should verify that such information is current and complete. All products are sold subject to PLE's terms and conditions of sale supplied at the time of order acknowledgment.

PLE warrants performance of this product to the specifications applicable at the time of sale in accordance with PLE's limited warranty. Testing and other quality control techniques are used to the extent PLE deems necessary to support this warranty. Except where mandated by specific contractual documents, testing of all parameters of each product is not necessarily performed.

PLE assumes no liability for application assistance or customer product design. Customers are responsible for their products and applications using PLE components. To minimize the risks associated with the customer products and applications, customers should provide adequate design and operating safeguards.

PLE products are not designed, intended, authorized or warranted to be suitable for use in life support applications, weapons, weapons systems or space applications, devices or systems or other critical applications that may involve potential risks of death, personal injury or severe property or environmental damage. Inclusion of PLE products in such applications is understood to be fully at the risk of the customer. Use of PLE products in such applications requires the written approval of an appropriate PLE officer. Questions concerning potential risk applications should be directed to PLE.

PLE does not warrant or represent that any license, either express or implied, is granted under any PLE patent right, copyright, artwork or other intellectual property right relating to any combination, machine or process which PLE product or services are used. Information published by PLE regarding third-party products or services does not constitute a license from PLE to use such products or services or a warranty or endorsement thereof. Use of such information may require a license from a third party under the patents or other intellectual property of the third party, or a license from PLE under the patents or other intellectual property of PLE.

Reproduction of information in PLE data sheets or web site is permissible only if the reproduction is without alteration and is accompanied by associated warranties, conditions, limitations and notices. Reproduction of this information with alteration is an unfair and deceptive business practice. PLE is not responsible or liable for such altered documents.

Resale of PLE products or services with statements different from or beyond the parameters stated by PLE for that product or service voids all express and implied warranties for the associated PLE product or service and is an unfair or deceptive business practice. PLE is not responsible for any such statements.

Contacting Pletronics Inc.

Pletronics, Inc.
19013 36th Ave. West
Lynnwood, WA 98036-5761
U.S.A.

Tel: 425.776.1880
Fax: 425.776.2760
email: ple-sales@pletronics.com
URL: www.pletronics.com

Mouser Electronics

Authorized Distributor

Click to View Pricing, Inventory, Delivery & Lifecycle Information:

[Pletronics:](#)

[QP7720LEV-156.25M](#)