

Plug - PP-H 2,5/1-L RD - 3061924

Please be informed that the data shown in this PDF Document is generated from our Online Catalog. Please find the complete data in the user's documentation. Our General Terms of Use for Downloads are valid (<http://phoenixcontact.com/download>)



Plug, nom. voltage: 500 V, nominal current: 24 A, connection method: Push-in connection, number of connections: 1, number of positions: 1, cross section: 0.14 mm² - 4 mm², AWG: 26 - 12, width: 5.2 mm, height: 39 mm, color: red

Product Description

Connector element left, left housing without engagement pin, right opened without cover

Your advantages

- Large-surface labeling option
- The Push-in technology COMBI plugs for self-assembly provide solutions that users can implement themselves
- The plug is assembled directly on site by snapping together single-position plug elements



Key Commercial Data

Packing unit	50 pc
GTIN	
GTIN	4055626082240

Technical data

General

Number of positions	1
Number of levels	1
Number of connections	1
Potentials	1
Nominal cross section	2.5 mm ²
Color	red
Insulating material	PA
Flammability rating according to UL 94	V0
Assembly instructions	Use of a parallel pressing tool is recommended for easy latching of the COMBI connector and coupling elements for self-assembly
Maximum load current	24 A (with a 2.5 mm ² conductor cross section)
Rated surge voltage	6 kV

Plug - PP-H 2,5/1-L RD - 3061924

Technical data

General

Degree of pollution	3
Overvoltage category	III
Insulating material group	I
Maximum power dissipation for nominal condition	0.77 W
Maximum load current	24 A (with 4 mm ² conductor cross section)
Nominal current I _N	24 A
Nominal voltage U _N	500 V
Open side panel	No
Relative insulation material temperature index (Elec., UL 746 B)	125 °C
Temperature index of insulation material (DIN EN 60216-1 (VDE 0304-21))	125 °C
Static insulating material application in cold	-60 °C

Dimensions

Width	5.2 mm
Length	15.8 mm
Height	39 mm
	24 mm
Pitch	5.2 mm

Connection data

Connection	1 level
Connection method	Push-in connection
Stripping length	10 mm
Connection in acc. with standard	IEC 61984
Conductor cross section solid min.	0.14 mm ²
Conductor cross section solid max.	4 mm ²
Conductor cross section AWG min.	26
Conductor cross section AWG max.	12
Conductor cross section flexible min.	0.14 mm ²
Conductor cross section flexible max.	2.5 mm ²
Min. AWG conductor cross section, flexible	26
Max. AWG conductor cross section, flexible	14
Conductor cross section flexible, with ferrule without plastic sleeve min.	0.14 mm ²
Conductor cross section flexible, with ferrule without plastic sleeve max.	2.5 mm ²
Conductor cross section flexible, with ferrule with plastic sleeve min.	0.14 mm ²
Conductor cross section flexible, with ferrule with plastic sleeve max.	2.5 mm ²
Two conductors with the same cross section, flexible, with TWIN ferrules, with plastic sleeve, maximum	0.5 mm ²
Connection cross sections directly pluggable	0.34 mm ² 4 mm ²
Conductor cross section solid min.	0.34 mm ²
Conductor cross section solid max.	4 mm ²

Plug - PP-H 2,5/1-L RD - 3061924

Technical data

Connection data

Conductor cross section flexible, with ferrule without plastic sleeve min.	0.34 mm ²
Conductor cross section flexible, with ferrule without plastic sleeve max.	2.5 mm ²
Conductor cross section flexible, with ferrule with plastic sleeve min.	0.34 mm ²
Conductor cross section flexible, with ferrule with plastic sleeve max.	2.5 mm ²
Internal cylindrical gage	A3

Standards and Regulations

Connection in acc. with standard	IEC 61984
Flammability rating according to UL 94	V0

Environmental Product Compliance

China RoHS	Environmentally friendly use period: unlimited = EFUP-e
	No hazardous substances above threshold values

Drawings

Plug - PP-H 2,5/1-L RD - 3061924

Schematic diagram

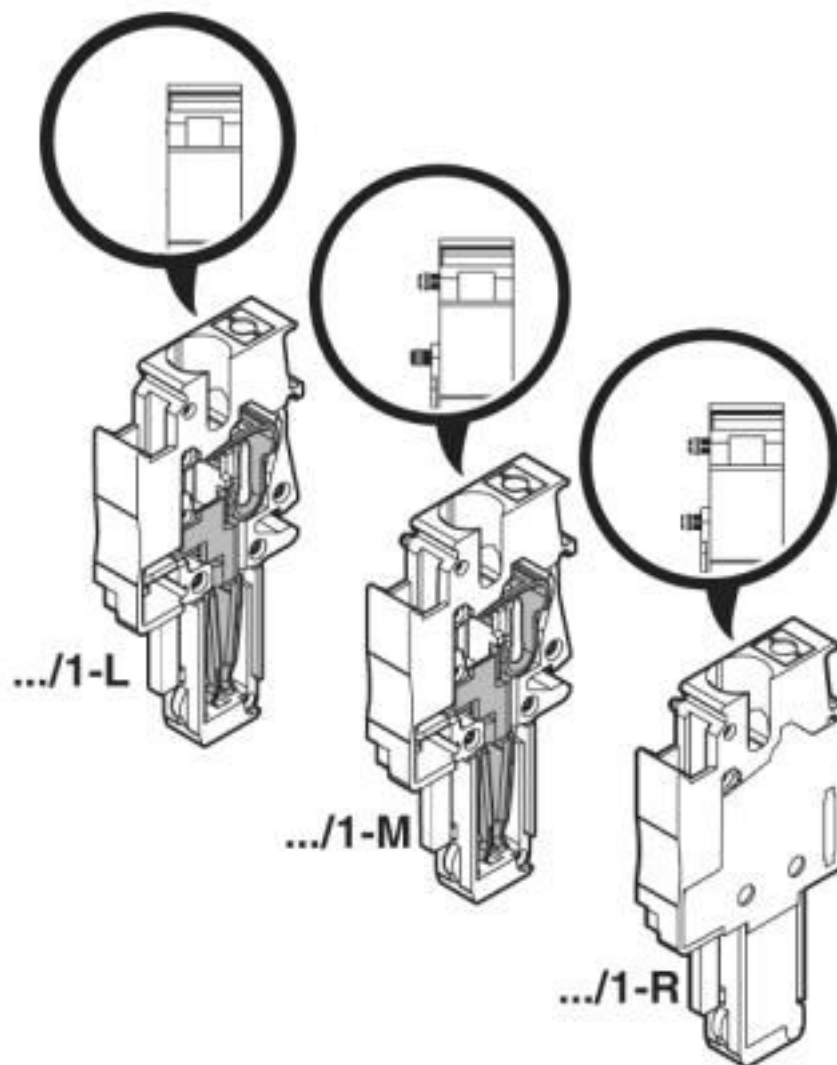

Plug - PP-H 2,5/1-L RD - 3061924

Diagram

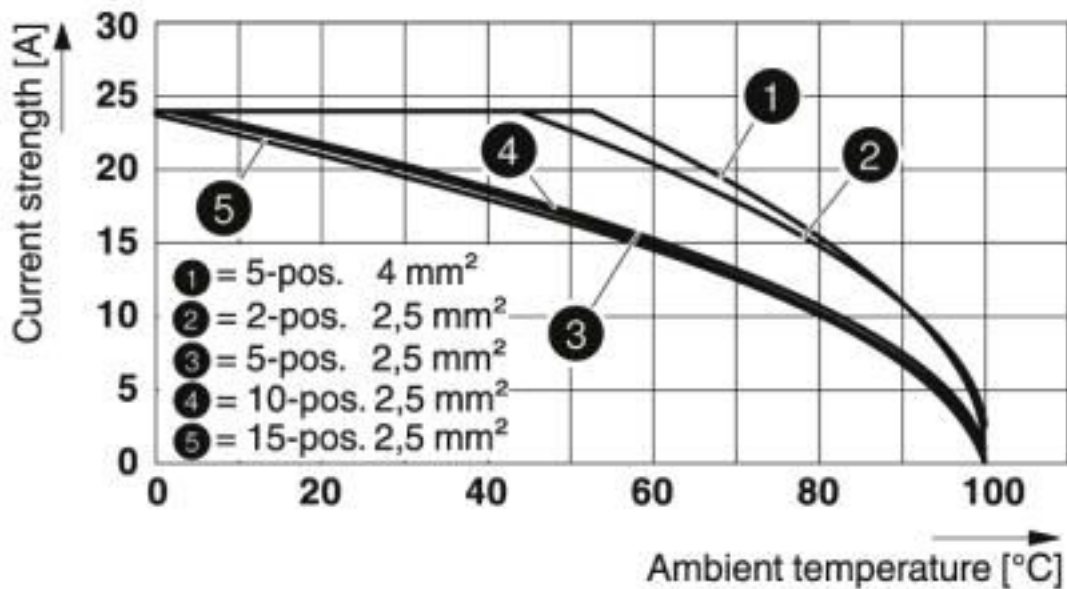

Circuit diagram



Classifications

eCl@ss

eCl@ss 10.0.1	27141151
eCl@ss 4.0	27260700
eCl@ss 4.1	27260700
eCl@ss 5.0	27260700
eCl@ss 5.1	27260700
eCl@ss 6.0	27141100
eCl@ss 7.0	27141151
eCl@ss 8.0	27141151
eCl@ss 9.0	27141151

ETIM

ETIM 3.0	EC000897
ETIM 4.0	EC002021
ETIM 5.0	EC002021
ETIM 6.0	EC002021
ETIM 7.0	EC002021

Plug - PP-H 2,5/1-L RD - 3061924

Classifications

UNSPSC

UNSPSC 6.01	30211802
UNSPSC 7.0901	39121402
UNSPSC 11	39121402
UNSPSC 12.01	39121402
UNSPSC 13.2	39121402
UNSPSC 18.0	39121402
UNSPSC 19.0	39121402
UNSPSC 20.0	39121402
UNSPSC 21.0	39121402

Approvals

Approvals

Approvals

DNV GL / CSA / BV / NK / ABS / UL Recognized / cUL Recognized / EAC / RS / EAC / LR / cULus Recognized

Ex Approvals

Approval details

DNV GL		https://approvalfinder.dnvgl.com/	TAE00003JE
--------	--	---	------------

CSA		http://www.csagroup.org/services-industries/product-listing/	13631
	B	C	
Nominal voltage UN	300 V	300 V	
Nominal current IN	20 A	20 A	
mm ² /AWG/kcmil	26-12	26-12	

BV		http://www.veristar.com/portal/veristarinfo/generalinfo/approved/approvedProducts/equipmentAndMaterials	25278/B0 BV
----	--	---	-------------

NK		http://www.classnk.or.jp/hp/en/	14ME0912
----	--	---	----------

Plug - PP-H 2,5/1-L RD - 3061924

Approvals

ABS <http://www.eagle.org/eagleExternalPortalWEB/> 16-HG1591536-PDA

UL Recognized  <http://database.ul.com/cgi-bin/XYV/template/LISEXT/1FRAME/index.htm> FILE E 60425

	B	C	D
Nominal voltage UN	300 V	300 V	600 V
Nominal current IN	20 A	20 A	5 A
mm ² /AWG/kcmil	26-12	26-12	26-12

cUL Recognized  <http://database.ul.com/cgi-bin/XYV/template/LISEXT/1FRAME/index.htm> FILE E 60425

	B	C	D
Nominal voltage UN	300 V	300 V	600 V
Nominal current IN	20 A	20 A	5 A
mm ² /AWG/kcmil	26-12	26-12	26-12

EAC  RU C-DE.A*30.B.01742

RS  <http://www.rs-head.spb.ru/en/index.php> 17.00013.272

EAC  RU C-DE.BL08.B.00511

LR  <http://www.lr.org/en> 12/20038 (E3)

cULus Recognized 

Accessories

Accessories

Cable housing

Plug - PP-H 2,5/1-L RD - 3061924

Accessories

Cable housing - PH 2,5/ 2 - 3209691



Cable housing, pitch: 10.4 mm, length: 19.9 mm, width: 10.4 mm, height: 36.8 mm, number of positions: 2, color: gray

Cable housing - PH 2,5/ 3 - 3209701



Cable housing, pitch: 15.6 mm, length: 19.9 mm, width: 15.6 mm, height: 36.8 mm, number of positions: 3, color: gray

Cable housing - PH 2,5/ 4 - 3209714



Cable housing, pitch: 20.8 mm, length: 19.9 mm, width: 20.8 mm, height: 36.8 mm, number of positions: 4, color: gray

Cable housing - PH 2,5/ 5 - 3209727



Cable housing, pitch: 26 mm, length: 19.9 mm, width: 26 mm, height: 36.8 mm, number of positions: 5, color: gray

Cable housing - PH 2,5/ 6 - 3209730



Cable housing, pitch: 31.2 mm, length: 19.9 mm, width: 31.2 mm, height: 36.8 mm, number of positions: 6, color: gray

Plug - PP-H 2,5/1-L RD - 3061924

Accessories

Cable housing - PH 2,5/ 7 - 3209743



Cable housing, pitch: 36.4 mm, length: 19.9 mm, width: 36.4 mm, height: 36.8 mm, number of positions: 7, color: gray

Cable housing - PH 2,5/ 8 - 3209756



Cable housing, pitch: 41.6 mm, length: 19.9 mm, width: 41.6 mm, height: 36.8 mm, number of positions: 8, color: gray

Cable housing - PH 2,5/ 9 - 3209507



Cable housing, pitch: 46.8 mm, length: 19.9 mm, width: 46.8 mm, height: 36.8 mm, number of positions: 9, color: gray

Cable housing - PH 2,5/10 - 3209769



Cable housing, pitch: 52 mm, length: 19.9 mm, width: 52 mm, height: 36.8 mm, number of positions: 10, color: gray

Cable housing - PH 2,5/11 - 3209772



Cable housing, pitch: 57.2 mm, length: 19.9 mm, width: 57.2 mm, height: 36.8 mm, number of positions: 11, color: gray

Plug - PP-H 2,5/1-L RD - 3061924

Accessories

Cable housing - PH 2,5/12 - 3209785



Cable housing, pitch: 62.4 mm, length: 19.9 mm, width: 62.4 mm, height: 36.8 mm, number of positions: 12, color: gray

Cable housing - PH 2,5/13 - 3209798



Cable housing, pitch: 67.6 mm, length: 19.9 mm, width: 67.6 mm, height: 36.8 mm, number of positions: 13, color: gray

Cable housing - PH 2,5/14 - 3209808



Cable housing, pitch: 72.8 mm, length: 19.9 mm, width: 72.8 mm, height: 36.8 mm, number of positions: 14, color: gray

Cable housing - PH 2,5/15 - 3209811



Cable housing, pitch: 78 mm, length: 19.9 mm, width: 78 mm, height: 36.8 mm, number of positions: 15, color: gray

End cover

Flange cover - DF-SP-H 2,5 - 3209824



Flange cover, length: 35.8 mm, width: 4.5 mm, height: 24.7 mm, color: gray

Flange

Plug - PP-H 2,5/1-L RD - 3061924

Accessories

Flange cover - DFS-SP-H 2,5 - 3061431



Flange cover, length: 35.8 mm, width: 4.5 mm, height: 24.7 mm, color: gray

Insulating sleeve

Insulating sleeve - MPS-IH WH - 0201663

Insulating sleeve, color: white



Insulating sleeve - MPS-IH RD - 0201676

Insulating sleeve, color: red



Insulating sleeve - MPS-IH BU - 0201689

Insulating sleeve, color: blue



Insulating sleeve - MPS-IH YE - 0201692

Insulating sleeve, color: yellow



Plug - PP-H 2,5/1-L RD - 3061924

Accessories

Insulating sleeve - MPS-IH GN - 0201702

Insulating sleeve, color: green



Insulating sleeve - MPS-IH GY - 0201728

Insulating sleeve, color: gray



Insulating sleeve - MPS-IH BK - 0201731

Insulating sleeve, color: black



Insulating sleeve - ISH 2,5/0,2 - 3002843

Insulating sleeve, color: white



Insulating sleeve - ISH 2,5/0,5 - 3002856

Insulating sleeve, color: gray



Plug - PP-H 2,5/1-L RD - 3061924

Accessories

Insulating sleeve - ISH 2,5/1,0 - 3002869



Insulating sleeve, color: black

Labeled terminal marker

Zack Marker strip, flat - ZBF 5 CUS - 0825025



Zack Marker strip, flat, can be ordered: Strip, white, labeled according to customer specifications, mounting type: snap into flat marker groove, for terminal block width: 5 mm, lettering field size: 5.15 x 5.15 mm, Number of individual labels: 10

Zack Marker strip, flat - ZBF 5,LGS:FORTL.ZAHLEN - 0808671



Zack Marker strip, flat, Strip, white, labeled, printed horizontally: consecutive numbers 1 ... 10, 11 ... 20, etc. up to 491 ... 500, mounting type: snap into flat marker groove, for terminal block width: 5 mm, lettering field size: 5.15 x 5.15 mm, Number of individual labels: 10

Zack Marker strip, flat - ZBF 5,QR:FORTL.ZAHLEN - 0808697



Zack Marker strip, flat, Strip, white, labeled, Printed vertically: consecutive numbers 1 ... 10, 11 ... 20, etc. up to 91 ... 100, mounting type: snap into flat marker groove, for terminal block width: 5 mm, lettering field size: 5.15 x 5.15 mm, Number of individual labels: 10

Zack Marker strip, flat - ZBF 5,LGS:GERADE ZAHLEN - 0810821



Zack Marker strip, flat, Strip, white, labeled, printed horizontally: consecutive numbers 2 ... 20, 22 ... 40, etc. up to 82 ... 100, mounting type: snap into flat marker groove, for terminal block width: 5 mm, lettering field size: 5.15 x 5.15 mm, Number of individual labels: 10

Plug - PP-H 2,5/1-L RD - 3061924

Accessories

Zack Marker strip, flat - ZBF 5,LGS:UNGERADE ZAHLEN - 0810863



Zack Marker strip, flat, Strip, white, labeled, printed horizontally: Odd numbers 1 - 19, 21 - 39, etc. up to 81 - 99, mounting type: snap into flat marker groove, for terminal block width: 5 mm, lettering field size: 5.15 x 5.15 mm, Number of individual labels: 10

Marker for terminal blocks - UC-TMF 5 CUS - 0824638



Marker for terminal blocks, can be ordered: by sheet, white, labeled according to customer specifications, mounting type: snap into flat marker groove, for terminal block width: 5.2 mm, lettering field size: 4.6 x 5.1 mm, Number of individual labels: 96

Marker for terminal blocks - UCT-TMF 5 CUS - 0829658



Marker for terminal blocks, can be ordered: by sheet, white, labeled according to customer specifications, mounting type: snap into flat marker groove, for terminal block width: 5.2 mm, lettering field size: 4.4 x 4.7 mm, Number of individual labels: 72

Mounting material

Latching - PR - 3040559



Latching, length: 29.8 mm, width: 4.4 mm, number of positions: 1, color: orange

Latching - PR/2 - 3040630



Latching, length: 29.8 mm, width: 10 mm, number of positions: 2, color: orange

Plug - PP-H 2,5/1-L RD - 3061924

Accessories

Latching - PRT/2 - 3040631



Latching, can only be released using a screwdriver, length: 23.2 mm, width: 9 mm, number of positions: 2, color: orange

Latching - PRZ - 3040614



Latching, length: 63.6 mm, width: 9.7 mm, number of positions: 2, color: orange

Screwdriver tools

Actuation tool - ST-BW - 1207608



Actuation tool, for all 2.5 mm² - 4.0 mm² spring-cages

Shield connection

Shield connection clamp - PSH 3- 6 - 3040591



Shield connection clamp, color: black

Shield connection clamp - PSH 5-10 - 3040601



Shield connection clamp, color: black

Strain relief

Plug - PP-H 2,5/1-L RD - 3061924

Accessories

Strain relief - PZ/2 - 3040627



Strain relief, length: 48.7 mm, width: 9.3 mm, number of positions: 2, color: black

Strain relief - PZ/4 - 3040643



Strain relief, length: 48.7 mm, width: 19.6 mm, number of positions: 4, color: black

Terminal marking

Zack Marker strip, flat - ZBF 5:UNBEDRUCKT - 0808642



Zack Marker strip, flat, Strip, white, unlabeled, can be labeled with: PLOTMARK, CMS-P1-PLOTTER, mounting type: snap into flat marker groove, for terminal block width: 5 mm, lettering field size: 5.1 x 5.2 mm, Number of individual labels: 10

Marker for terminal blocks - UC-TMF 5 - 0818153



Marker for terminal blocks, Sheet, white, unlabeled, can be labeled with: BLUEMARK ID COLOR, BLUEMARK ID, BLUEMARK CLED, PLOTMARK, CMS-P1-PLOTTER, mounting type: snap into flat marker groove, for terminal block width: 5.2 mm, lettering field size: 4.6 x 5.1 mm, Number of individual labels: 96

Marker for terminal blocks - UCT-TMF 5 - 0828744



Marker for terminal blocks, Sheet, white, unlabeled, can be labeled with: TOPMARK NEO, TOPMARK LASER, BLUEMARK ID COLOR, BLUEMARK ID, BLUEMARK CLED, THERMOMARK PRIME, THERMOMARK CARD 2.0, THERMOMARK CARD, mounting type: snap into flat marker groove, for terminal block width: 5.2 mm, lettering field size: 4.4 x 4.7 mm, Number of individual labels: 72

Test plug terminal block

Plug - PP-H 2,5/1-L RD - 3061924

Accessories

Test plugs - MPS-MT - 0201744



Test plugs, with solder connection up to 1 mm² conductor cross section, color: gray

Phoenix Contact 2020 © - all rights reserved
<http://www.phoenixcontact.com>

PHOENIX CONTACT GmbH & Co. KG
Flachsmarktstr. 8
32825 Blomberg
Germany
Tel. +49 5235 300
Fax +49 5235 3 41200
<http://www.phoenixcontact.com>

Mouser Electronics

Authorized Distributor

Click to View Pricing, Inventory, Delivery & Lifecycle Information:

[Phoenix Contact:](#)

[3061924](#)