

## Ground modular terminal block - UT 2,5/1P-PE - 3045033

Please be informed that the data shown in this PDF Document is generated from our Online Catalog. Please find the complete data in the user's documentation. Our General Terms of Use for Downloads are valid (<http://phoenixcontact.com/download>)



Ground modular terminal block, connection method: Screw/plug-in connection, number of connections: 2, cross section: 0.14 mm<sup>2</sup> - 4 mm<sup>2</sup>, AWG: 26 - 12, width: 5.2 mm, color: green-yellow, mounting type: NS 35/7,5, NS 35/15

### Your advantages

- Same shape and pitch as the feed-through terminal blocks
- Contact is made free from mechanical and electrical errors by simply snapping onto the DIN rail
- All the requirements of standards IEC 61984 and IEC 60947-7-2 are met



### Key Commercial Data

Packing unit	50 pc
GTIN	 4 017918 975371
GTIN	4017918975371

### Technical data

#### General

Number of levels	1
Number of connections	2
Nominal cross section	2.5 mm <sup>2</sup>
Color	green-yellow
Insulating material	PA
Flammability rating according to UL 94	V0
Rated surge voltage	6 kV
Degree of pollution	3
Overvoltage category	III
Insulating material group	I
Open side panel	Yes
Relative insulation material temperature index (Elec., UL 746 B)	130 °C
Temperature index of insulation material (DIN EN 60216-1 (VDE 0304-21))	130 °C

# Ground modular terminal block - UT 2,5/1P-PE - 3045033

## Technical data

### General

Static insulating material application in cold	-60 °C
Surface flammability NFPA 130 (ASTM E 162)	passed
Specific optical density of smoke NFPA 130 (ASTM E 662)	passed
Calorimetric heat release NFPA 130 (ASTM E 1354)	28 MJ/kg
Smoke gas toxicity NFPA 130 (SMP 800C)	passed
Fire protection for rail vehicles (DIN EN 45545-2) R22	HL 1 - HL 3
Fire protection for rail vehicles (DIN EN 45545-2) R23	HL 1 - HL 3
Fire protection for rail vehicles (DIN EN 45545-2) R24	HL 1 - HL 3
Fire protection for rail vehicles (DIN EN 45545-2) R26	HL 1 - HL 3

### Dimensions

Width	5.2 mm
End cover width	2.2 mm
Length	49.1 mm
Height NS 35/7,5	47.5 mm
Height NS 35/15	55 mm

### Connection data

Note	Please observe the current carrying capacity of the DIN rails.
Connection method	Screw/plug-in connection
Screw thread	M3
Stripping length	9 mm
Tightening torque, min	0.5 Nm
Tightening torque max	0.6 Nm
Connection in acc. with standard	IEC 61984
Conductor cross section solid min.	0.14 mm <sup>2</sup>
Conductor cross section solid max.	4 mm <sup>2</sup>
Conductor cross section AWG min.	26
Conductor cross section AWG max.	12
Conductor cross section flexible min.	0.14 mm <sup>2</sup>
Conductor cross section flexible max.	4 mm <sup>2</sup>
Min. AWG conductor cross section, flexible	26
Max. AWG conductor cross section, flexible	12
Conductor cross section flexible, with ferrule without plastic sleeve min.	0.14 mm <sup>2</sup>
Conductor cross section flexible, with ferrule without plastic sleeve max.	2.5 mm <sup>2</sup>
Conductor cross section flexible, with ferrule with plastic sleeve min.	0.14 mm <sup>2</sup>
Conductor cross section flexible, with ferrule with plastic sleeve max.	2.5 mm <sup>2</sup>
2 conductors with same cross section, solid min.	0.14 mm <sup>2</sup>
2 conductors with same cross section, solid max.	1.5 mm <sup>2</sup>
2 conductors with same cross section, stranded min.	0.14 mm <sup>2</sup>
2 conductors with same cross section, stranded max.	1.5 mm <sup>2</sup>

## Ground modular terminal block - UT 2,5/1P-PE - 3045033

### Technical data

#### Connection data

Two conductors with the same cross section, flexible, with TWIN ferrules, with plastic sleeve, minimum	0.5 mm <sup>2</sup>
Two conductors with the same cross section, flexible, with TWIN ferrules, with plastic sleeve, maximum	1.5 mm <sup>2</sup>
Two conductors with the same cross section stranded, with ferrule and without plastic sleeve, minimum	0.14 mm <sup>2</sup>
Two conductors with the same cross section stranded, with ferrule and without plastic sleeve, maximum	1.5 mm <sup>2</sup>
Internal cylindrical gage	A3

#### Standards and Regulations

Connection in acc. with standard	CSA
	IEC 61984
Flammability rating according to UL 94	V0

#### Environmental Product Compliance

REACH SVHC	Lead 7439-92-1
China RoHS	Environmentally Friendly Use Period = 50 years
	For details about hazardous substances go to tab "Downloads", Category "Manufacturer's declaration"

### Drawings

# Ground modular terminal block - UT 2,5/1P-PE - 3045033

Diagram

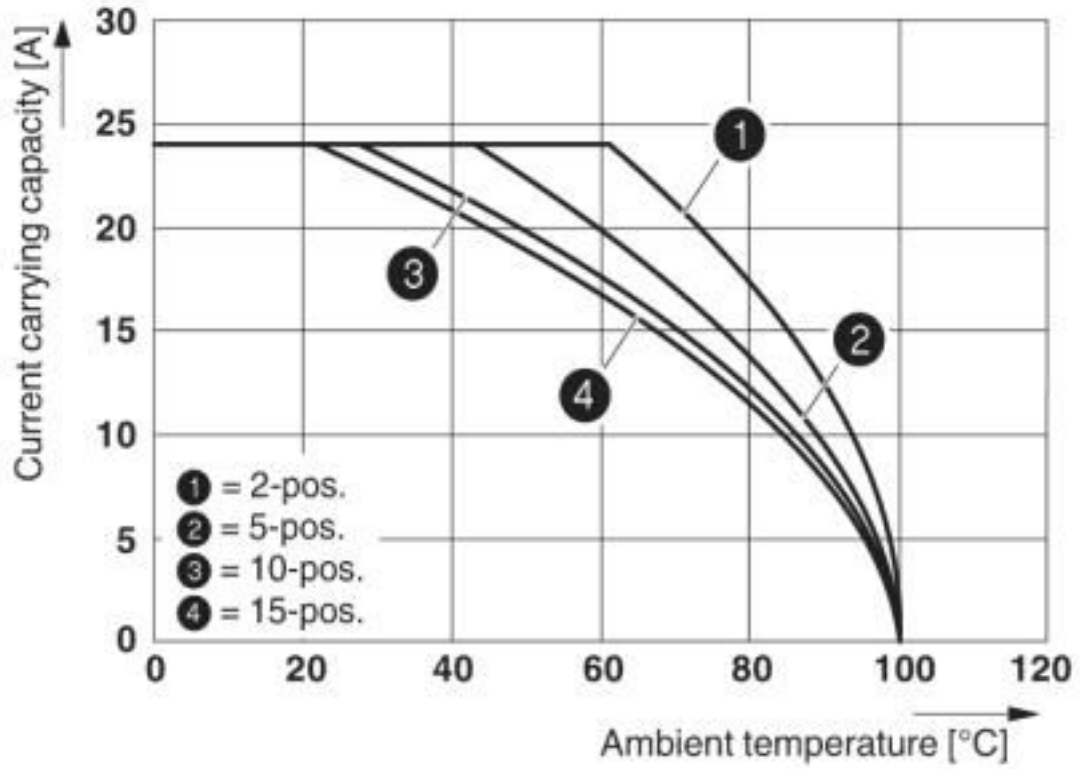

## Ground modular terminal block - UT 2,5/1P-PE - 3045033

Diagram

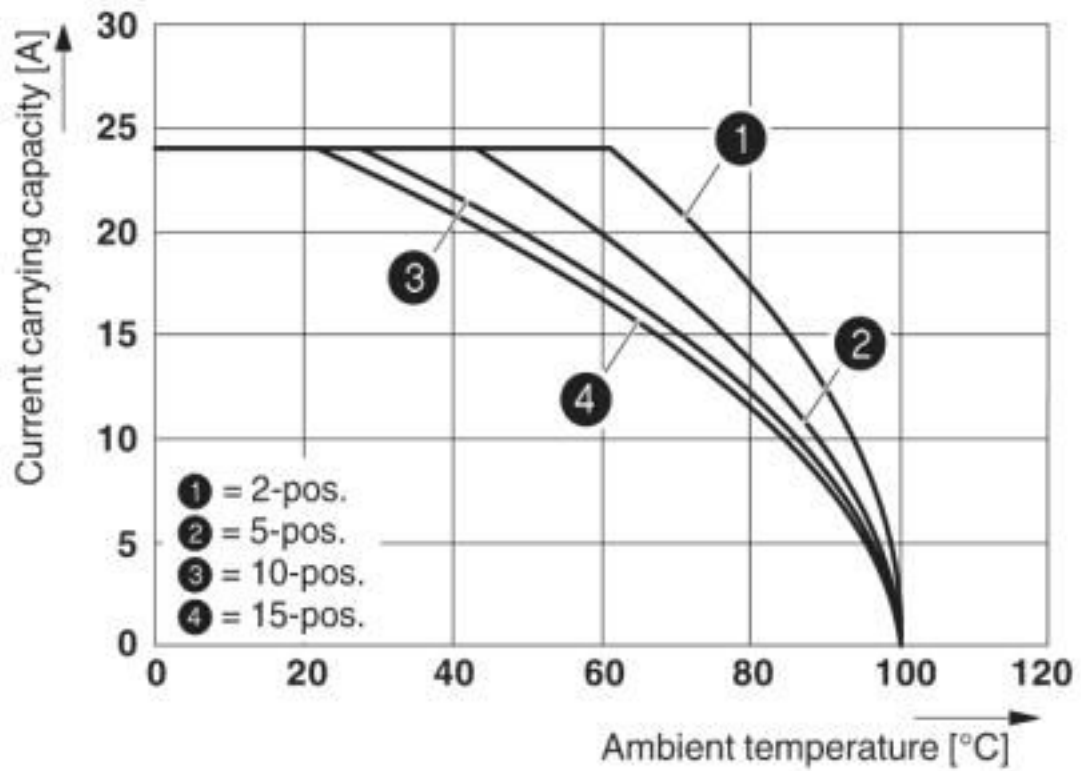

The figure shows the derating curve of the UT 2,5/1P... terminal block in connection with the UPBV 2,5 plug

## Ground modular terminal block - UT 2,5/1P-PE - 3045033

Dimensional drawing

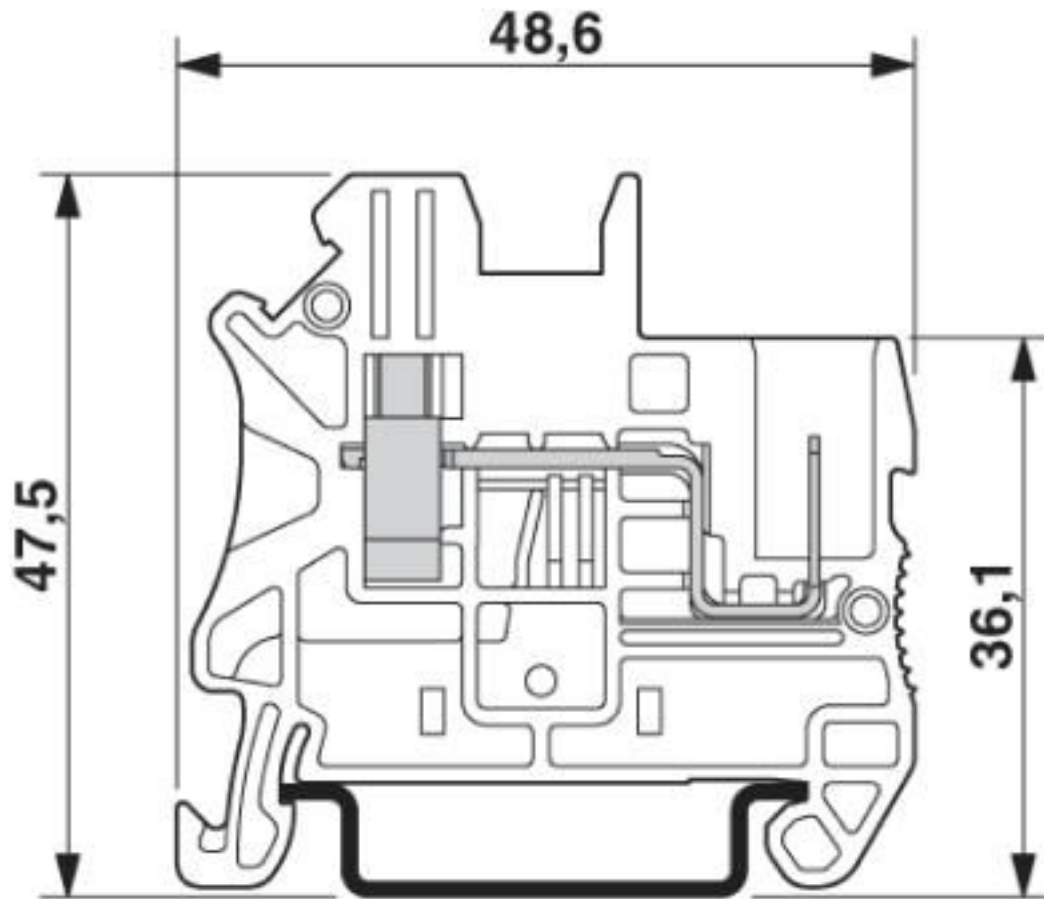

# Ground modular terminal block - UT 2,5/1P-PE - 3045033

Circuit diagram

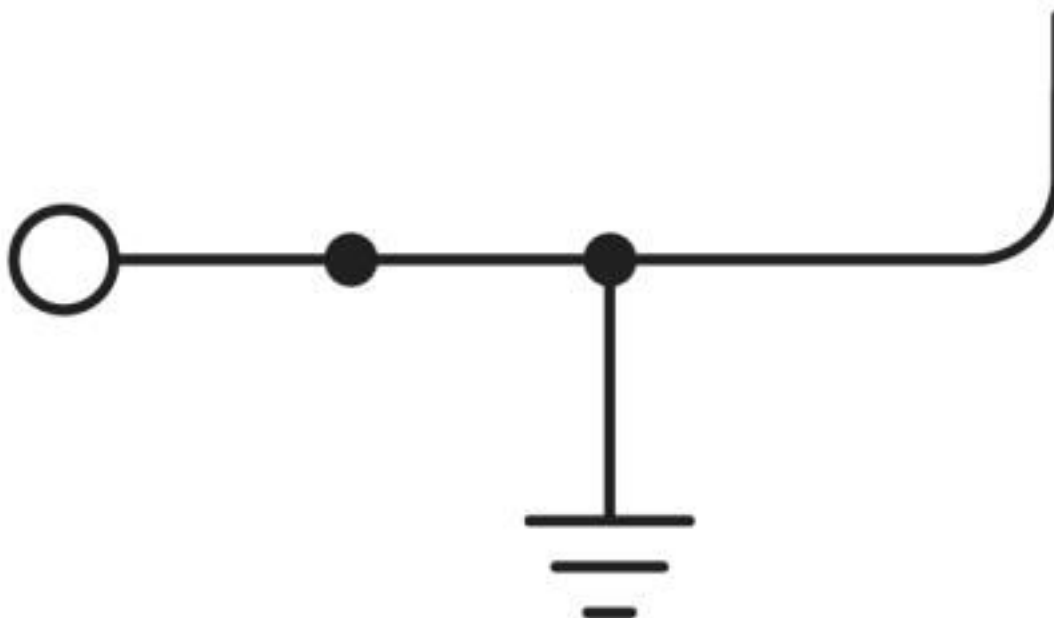

## Classifications

eCl@ss

eCl@ss 10.0.1	27141141
eCl@ss 4.0	27141100
eCl@ss 4.1	27141100
eCl@ss 5.0	27141100
eCl@ss 5.1	27141100
eCl@ss 6.0	27141100
eCl@ss 7.0	27141141
eCl@ss 8.0	27141141
eCl@ss 9.0	27141141

ETIM

ETIM 2.0	EC000901
ETIM 3.0	EC000901
ETIM 4.0	EC000901
ETIM 5.0	EC000901
ETIM 6.0	EC000901
ETIM 7.0	EC000901

UNSPSC

UNSPSC 6.01	30211811
UNSPSC 7.0901	39121410
UNSPSC 11	39121410

# Ground modular terminal block - UT 2,5/1P-PE - 3045033

## Classifications

### UNSPSC

UNSPSC 12.01	39121410
UNSPSC 13.2	39121410
UNSPSC 18.0	39121410
UNSPSC 19.0	39121410
UNSPSC 20.0	39121410
UNSPSC 21.0	39121410

## Approvals

### Approvals

#### Approvals

CSA / UL Recognized / cUL Recognized / EAC / EAC / cULus Recognized

#### Ex Approvals

### Approval details

CSA		<a href="http://www.csagroup.org/services-industries/product-listing/">http://www.csagroup.org/services-industries/product-listing/</a>	13631
		B	C
mm <sup>2</sup> /AWG/kcmil		26-12	26-12

UL Recognized		<a href="http://database.ul.com/cgi-bin/XYV/template/LISEXT/1FRAME/index.htm">http://database.ul.com/cgi-bin/XYV/template/LISEXT/1FRAME/index.htm</a>	FILE E 60425
mm <sup>2</sup> /AWG/kcmil		26-12	

cUL Recognized		<a href="http://database.ul.com/cgi-bin/XYV/template/LISEXT/1FRAME/index.htm">http://database.ul.com/cgi-bin/XYV/template/LISEXT/1FRAME/index.htm</a>	FILE E 60425
mm <sup>2</sup> /AWG/kcmil		26-12	

EAC			RU C- DE.A*30.B.01742
-----	---	--	--------------------------



## Ground modular terminal block - UT 2,5/1P-PE - 3045033

### Approvals

EAC		RU C- DE.BL08.B.00534
-----	--	--------------------------

cULus Recognized	
------------------	--

### Accessories

#### Accessories

#### Bridge

Wire bridge - FBSW 2-5/250MM - 3030172



Wire bridge, length: 250 mm, width: 5.1 mm, number of positions: 1, color: red/black

Wire bridge - FBSW 2-5/60MM - 3030170



Wire bridge, length: 60 mm, width: 5.1 mm, number of positions: 1, color: red/black

Wire bridge - FBSW 2-5/110MM - 3030171



Wire bridge, length: 110 mm, width: 5.1 mm, number of positions: 1, color: red/black

#### Coding element

Coding star - PC - 3040588



Coding star, length: 3 mm, width: 3 mm, height: 6 mm, color: red

## Ground modular terminal block - UT 2,5/1P-PE - 3045033

### Accessories

---

#### DIN rail

DIN rail perforated - NS 35/ 7,5 PERF 2000MM - 0801733



DIN rail perforated, Standard profile, width: 35 mm, height: 7.5 mm, acc. to EN 60715, material: Steel, galvanized, passivated with a thick layer, length: 2000 mm, color: silver

---

DIN rail, unperforated - NS 35/ 7,5 UNPERF 2000MM - 0801681



DIN rail, unperforated, Standard profile, width: 35 mm, height: 7.5 mm, acc. to EN 60715, material: Steel, galvanized, passivated with a thick layer, length: 2000 mm, color: silver

---

DIN rail perforated - NS 35/ 7,5 WH PERF 2000MM - 1204119



DIN rail perforated, Standard profile, width: 35 mm, height: 7.5 mm, acc. to EN 60715, material: Steel, Galvanized, white passivated, length: 2000 mm, color: silver

---

DIN rail, unperforated - NS 35/ 7,5 WH UNPERF 2000MM - 1204122



DIN rail, unperforated, Standard profile, width: 35 mm, height: 7.5 mm, acc. to EN 60715, material: Steel, Galvanized, white passivated, length: 2000 mm, color: silver

---

DIN rail, unperforated - NS 35/ 7,5 AL UNPERF 2000MM - 0801704



DIN rail, unperforated, Standard profile, width: 35 mm, height: 7.5 mm, acc. to EN 60715, material: Aluminum, uncoated, length: 2000 mm, color: silver

---

## Ground modular terminal block - UT 2,5/1P-PE - 3045033

### Accessories

DIN rail perforated - NS 35/ 7,5 ZN PERF 2000MM - 1206421



DIN rail perforated, Standard profile, width: 35 mm, height: 7.5 mm, acc. to EN 60715, material: Steel, galvanized, length: 2000 mm, color: silver

---

DIN rail, unperforated - NS 35/ 7,5 ZN UNPERF 2000MM - 1206434



DIN rail, unperforated, Standard profile, width: 35 mm, height: 7.5 mm, acc. to EN 60715, material: Steel, galvanized, length: 2000 mm, color: silver

---

DIN rail, unperforated - NS 35/ 7,5 CU UNPERF 2000MM - 0801762



DIN rail, unperforated, Standard profile, width: 35 mm, height: 7.5 mm, acc. to EN 60715, material: Copper, uncoated, length: 2000 mm, color: copper-colored

---

End cap - NS 35/ 7,5 CAP - 1206560



DIN rail end piece, for DIN rail NS 35/7.5

---

DIN rail perforated - NS 35/15 PERF 2000MM - 1201730



DIN rail perforated, Standard profile, width: 35 mm, height: 15 mm, similar to EN 60715, material: Steel, galvanized, passivated with a thick layer, length: 2000 mm, color: silver

---

## Ground modular terminal block - UT 2,5/1P-PE - 3045033

### Accessories

DIN rail, unperforated - NS 35/15 UNPERF 2000MM - 1201714

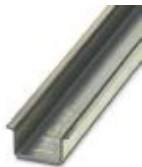

DIN rail, unperforated, Standard profile, width: 35 mm, height: 15 mm, similar to EN 60715, material: Steel, galvanized, passivated with a thick layer, length: 2000 mm, color: silver

---

DIN rail perforated - NS 35/15 WH PERF 2000MM - 0806602



DIN rail perforated, Standard profile, width: 35 mm, height: 15 mm, similar to EN 60715, material: Steel, Galvanized, white passivated, length: 2000 mm, color: silver

---

DIN rail, unperforated - NS 35/15 WH UNPERF 2000MM - 1204135



DIN rail, unperforated, Standard profile, width: 35 mm, height: 15 mm, similar to EN 60715, material: Steel, Galvanized, white passivated, length: 2000 mm, color: silver

---

DIN rail, unperforated - NS 35/15 AL UNPERF 2000MM - 1201756



DIN rail, unperforated, Standard profile, width: 35 mm, height: 15 mm, similar to EN 60715, material: Aluminum, uncoated, length: 2000 mm, color: silver

---

DIN rail perforated - NS 35/15 ZN PERF 2000MM - 1206599



DIN rail perforated, Standard profile, width: 35 mm, height: 15 mm, similar to EN 60715, material: Steel, galvanized, length: 2000 mm, color: silver

---

## Ground modular terminal block - UT 2,5/1P-PE - 3045033

### Accessories

DIN rail, unperforated - NS 35/15 ZN UNPERF 2000MM - 1206586



DIN rail, unperforated, Standard profile, width: 35 mm, height: 15 mm, similar to EN 60715, material: Steel, galvanized, length: 2000 mm, color: silver

---

DIN rail, unperforated - NS 35/15 CU UNPERF 2000MM - 1201895



DIN rail, unperforated, Standard profile, width: 35 mm, height: 15 mm, similar to EN 60715, material: Copper, uncoated, length: 2000 mm, color: copper-colored

---

End cap - NS 35/15 CAP - 1206573



DIN rail end piece, for DIN rail NS 35/15

---

DIN rail, unperforated - NS 35/15-2,3 UNPERF 2000MM - 1201798



DIN rail, unperforated, Standard profile 2.3 mm, width: 35 mm, height: 15 mm, acc. to EN 60715, material: Steel, galvanized, passivated with a thick layer, length: 2000 mm, color: silver

---

### End block

End clamp - CLIPFIX 35 - 3022218



Quick mounting end clamp for NS 35/7,5 DIN rail or NS 35/15 DIN rail, with marking option, width: 9.5 mm, color: gray

---

## Ground modular terminal block - UT 2,5/1P-PE - 3045033

### Accessories

End clamp - CLIPFIX 35-5 - 3022276



Quick mounting end clamp for NS 35/7,5 DIN rail or NS 35/15 DIN rail, with marking option, with parking option for FBS...5, FBS...6, KSS 5, KSS 6, width: 5.15 mm, color: gray

End clamp - E/NS 35 N - 0800886



End clamp, width: 9.5 mm, color: gray

End cover

End cover - D-UT 2,5/1P - 3047154



End cover, length: 47.6 mm, width: 2.2 mm, height: 39.8 mm, color: gray

Flange

Screw flange - UT 2,5/1P-F - 3060445



Screw flange, for screwing COMBI plugs, with the same structure and pitch as the relevant COMBI terminal blocks

Insulating sleeve

Insulating sleeve - MPS-IH WH - 0201663

Insulating sleeve, color: white



## Ground modular terminal block - UT 2,5/1P-PE - 3045033

### Accessories

Insulating sleeve - MPS-IH RD - 0201676

Insulating sleeve, color: red



Insulating sleeve - MPS-IH BU - 0201689

Insulating sleeve, color: blue



Insulating sleeve - MPS-IH YE - 0201692

Insulating sleeve, color: yellow



Insulating sleeve - MPS-IH GN - 0201702

Insulating sleeve, color: green



Insulating sleeve - MPS-IH GY - 0201728

Insulating sleeve, color: gray



## Ground modular terminal block - UT 2,5/1P-PE - 3045033

### Accessories

Insulating sleeve - MPS-IH BK - 0201731

Insulating sleeve, color: black



### Jumper

Plug-in bridge - FBS 2-5 - 3030161



Plug-in bridge, pitch: 5.2 mm, length: 22.7 mm, width: 9 mm, number of positions: 2, color: red

---

Plug-in bridge - FBS 3-5 - 3030174



Plug-in bridge, pitch: 5.2 mm, length: 22.7 mm, width: 14.2 mm, number of positions: 3, color: red

---

Plug-in bridge - FBS 4-5 - 3030187



Plug-in bridge, pitch: 5.2 mm, length: 22.7 mm, width: 19.4 mm, number of positions: 4, color: red

---

Plug-in bridge - FBS 5-5 - 3030190



Plug-in bridge, pitch: 5.2 mm, length: 23 mm, width: 24.6 mm, number of positions: 5, color: red

---



## Ground modular terminal block - UT 2,5/1P-PE - 3045033

### Accessories

Plug-in bridge - FBS 10-5 - 3030213



Plug-in bridge, pitch: 5.2 mm, length: 22.7 mm, width: 50.6 mm, number of positions: 10, color: red

---

Plug-in bridge - FBS 20-5 - 3030226



Plug-in bridge, pitch: 5.2 mm, number of positions: 20, color: red

---

Plug-in bridge - FBS 50-5 - 3038930



Plug-in bridge, pitch: 5.2 mm, number of positions: 50, color: red

---

Plug-in bridge - FBS 2-5 BU - 3036877



Plug-in bridge, pitch: 5.2 mm, number of positions: 2, color: blue

---

Plug-in bridge - FBS 3-5 BU - 3036880



Plug-in bridge, pitch: 5.2 mm, number of positions: 3, color: blue

---

## Ground modular terminal block - UT 2,5/1P-PE - 3045033

### Accessories

Plug-in bridge - FBS 4-5 BU - 3036893



Plug-in bridge, pitch: 5.2 mm, number of positions: 4, color: blue

---

Plug-in bridge - FBS 5-5 BU - 3036903



Plug-in bridge, pitch: 5.2 mm, number of positions: 5, color: blue

---

Plug-in bridge - FBS 10-5 BU - 3036916



Plug-in bridge, pitch: 5.2 mm, number of positions: 10, color: blue

---

Plug-in bridge - FBS 20-5 BU - 3036929



Plug-in bridge, pitch: 5.2 mm, number of positions: 20, color: blue

---

Plug-in bridge - FBS 50-5 BU - 3032114



Plug-in bridge, pitch: 5.2 mm, number of positions: 50, color: blue

---

Labeled terminal marker

## Ground modular terminal block - UT 2,5/1P-PE - 3045033

### Accessories

Zack marker strip - ZB 5 CUS - 0824962



Zack marker strip, can be ordered: Strip, white, labeled according to customer specifications, mounting type: snap into tall marker groove, for terminal block width: 5.2 mm, lettering field size: 5.15 x 10.5 mm, Number of individual labels: 10

Zack marker strip - ZB 5,LGS:FORTL.ZAHLEN - 1050017



Zack marker strip, Strip, white, labeled, printed horizontally: consecutive numbers 1 ... 10, 11 ... 20, etc. up to 491 ... 500, mounting type: snap into tall marker groove, for terminal block width: 5.2 mm, lettering field size: 5.15 x 10.5 mm, Number of individual labels: 10

Zack marker strip - ZB 5,QR:FORTL.ZAHLEN - 1050020



Zack marker strip, white, Printed vertically: consecutive numbers 1 ... 10, 11 ... 20, etc. up to 491 ... 500, mounting type: snap into tall marker groove, for terminal block width: 5.2 mm, lettering field size: 5.15 x 10.5 mm

Zack marker strip - ZB 5,LGS:GLEICHE ZAHLEN - 1050033



Zack marker strip, Strip, white, labeled, can be labeled with: CMS-P1-PLOTTER, printed horizontally: Identical numbers 1 or 2, etc. up to 100, mounting type: snap into tall marker groove, for terminal block width: 5.2 mm, lettering field size: 5.15 x 10.5 mm, Number of individual labels: 10

Zack marker strip - ZB 5,LGS:L1-N,PE - 1050415



Zack marker strip, Strip, white, labeled, horizontal: L1, L2, L3, N, PE, L1, L2, L3, N, PE, mounting type: snap into tall marker groove, for terminal block width: 5.2 mm, lettering field size: 5.15 x 10.5 mm, Number of individual labels: 10

## Ground modular terminal block - UT 2,5/1P-PE - 3045033

### Accessories

#### Marker for terminal blocks - UC-TM 5 CUS - 0824581



Marker for terminal blocks, can be ordered: by sheet, white, labeled according to customer specifications, mounting type: snap into tall marker groove, for terminal block width: 5.2 mm, lettering field size: 10.5 x 4.6 mm, Number of individual labels: 96

---

#### Marker for terminal blocks - UCT-TM 5 CUS - 0829595



Marker for terminal blocks, can be ordered: by sheet, white, labeled according to customer specifications, mounting type: snap into tall marker groove, for terminal block width: 5.2 mm, lettering field size: 4.6 x 10.5 mm, Number of individual labels: 72

---

#### Marker pen

##### Marker pen - X-PEN 0,35 - 0811228



Marker pen without ink cartridge, for manual labeling of markers, labeling extremely wipe-proof, line thickness 0.35 mm

---

#### Partition plate

##### Partition plate - ATP-UT - 3047167



Partition plate, length: 53.4 mm, width: 2.2 mm, height: 45.7 mm, color: gray

---

#### Spacer plate - DP PS-5 - 3036725



Spacer plate, length: 22.4 mm, width: 5.2 mm, height: 29 mm, number of positions: 1, color: red

---

#### Screwdriver tools

## Ground modular terminal block - UT 2,5/1P-PE - 3045033

### Accessories

Screwdriver - SZS 0,6X3,5 - 1205053



Actuation tool, for ST terminal blocks, insulated, also suitable for use as a bladed screwdriver, size: 0.6 x 3.5 x 100 mm, 2-component grip, with non-slip grip

---

### Terminal marking

Zack marker strip - ZB 5 :UNBEDRUCKT - 1050004



Zack marker strip, Strip, white, unlabeled, can be labeled with: PLOTMARK, CMS-P1-PLOTTER, mounting type: snap into tall marker groove, for terminal block width: 5.2 mm, lettering field size: 5.1 x 10.5 mm, Number of individual labels: 10

---

Marker for terminal blocks - UC-TM 5 - 0818108



Marker for terminal blocks, Sheet, white, unlabeled, can be labeled with: BLUEMARK ID COLOR, BLUEMARK ID, BLUEMARK CLED, PLOTMARK, CMS-P1-PLOTTER, mounting type: snap into tall marker groove, for terminal block width: 5.2 mm, lettering field size: 10.5 x 4.6 mm, Number of individual labels: 96

---

Marker for terminal blocks - UCT-TM 5 - 0828734



Marker for terminal blocks, Sheet, white, unlabeled, can be labeled with: TOPMARK NEO, TOPMARK LASER, BLUEMARK ID COLOR, BLUEMARK ID, BLUEMARK CLED, THERMOMARK PRIME, THERMOMARK CARD 2.0, THERMOMARK CARD, mounting type: snap into tall marker groove, for terminal block width: 5.2 mm, lettering field size: 4.6 x 10.5 mm, Number of individual labels: 72

---

### Test plug terminal block

Test plugs - MPS-MT - 0201744



Test plugs, with solder connection up to 1 mm<sup>2</sup> conductor cross section, color: gray

## Ground modular terminal block - UT 2,5/1P-PE - 3045033

### Accessories

Test plugs - PS-5 - 3030983



Test plugs, Modular test plug, color: red

---

Test plugs - PS-5/2,3MM RD - 3038723



Test plugs, color: red

---

Test socket

Test adapter - PAI-4-FIX-5/6 BU - 3035975



4 mm test adapter, for terminal blocks with 5.2 mm and 6.2 mm pitch

---

Test adapter - PAI-4-FIX-5/6 OG - 3035974



4 mm test adapter, for terminal blocks with 5.2 mm and 6.2 mm pitch

---

Test adapter - PAI-4-FIX-5/6 YE - 3035977



4 mm test adapter, for terminal blocks with 5.2 mm and 6.2 mm pitch

---

## Ground modular terminal block - UT 2,5/1P-PE - 3045033

### Accessories

Test adapter - PAI-4-FIX-5/6 RD - 3035976



4 mm test adapter, for terminal blocks with 5.2 mm and 6.2 mm pitch

---

Test adapter - PAI-4-FIX-5/6 GN - 3035978



4 mm test adapter, for terminal blocks with 5.2 mm and 6.2 mm pitch

---

Test adapter - PAI-4-FIX-5/6 BK - 3035980



4 mm test adapter, for terminal blocks with 5.2 mm and 6.2 mm pitch

---

Test adapter - PAI-4-FIX-5/6 GY - 3035982



4 mm test adapter, for terminal blocks with 5.2 mm and 6.2 mm pitch

---

Test adapter - PAI-4-FIX-5/6 VT - 3035979



4 mm test adapter, for terminal blocks with 5.2 mm and 6.2 mm pitch

---

## Ground modular terminal block - UT 2,5/1P-PE - 3045033

### Accessories

Test adapter - PAI-4-FIX-5/6 BN - 3035981



4 mm test adapter, for terminal blocks with 5.2 mm and 6.2 mm pitch

---

Test adapter - PAI-4-FIX-5/6 WH - 3035983



4 mm test adapter, for terminal blocks with 5.2 mm and 6.2 mm pitch

---

Test adapter - PAI-4-N GY - 3032871



4 mm test adapter, for terminal blocks with 5.2 mm, 6.2 mm and 8.2 mm pitch

---

### Additional products

Plug - SP 2,5/ 1 - 3040258



Plug, number of positions: 1, connection method: Spring-cage connection, cross section: 0.08 mm<sup>2</sup>- 4 mm<sup>2</sup>, AWG: 28 - 12, nominal current: 24 A, nom. voltage: 500 V, width: 5.2 mm, color: gray

---

Plug - SP 2,5/ 2 - 3040261



Plug, number of positions: 2, connection method: Spring-cage connection, cross section: 0.08 mm<sup>2</sup>- 4 mm<sup>2</sup>, AWG: 28 - 12, nominal current: 24 A, nom. voltage: 500 V, width: 10.4 mm, color: gray

---



## Ground modular terminal block - UT 2,5/1P-PE - 3045033

### Accessories

#### Plug - SP 2,5/ 3 - 3040274



Plug, number of positions: 3, connection method: Spring-cage connection, cross section: 0.08 mm<sup>2</sup>- 4 mm<sup>2</sup>, AWG: 28 - 12, nominal current: 24 A, nom. voltage: 500 V, width: 15.6 mm, color: gray

---

#### Plug - SP 2,5/ 4 - 3040287



Plug, number of positions: 4, connection method: Spring-cage connection, cross section: 0.08 mm<sup>2</sup>- 4 mm<sup>2</sup>, AWG: 28 - 12, nominal current: 24 A, nom. voltage: 500 V, width: 20.8 mm, color: gray

---

#### Plug - SP 2,5/ 5 - 3040290



Plug, number of positions: 5, connection method: Spring-cage connection, cross section: 0.08 mm<sup>2</sup>- 4 mm<sup>2</sup>, AWG: 28 - 12, nominal current: 24 A, nom. voltage: 500 V, width: 26 mm, color: gray

---

#### Plug - SP 2,5/ 6 - 3040300



Plug, number of positions: 6, connection method: Spring-cage connection, cross section: 0.08 mm<sup>2</sup>- 4 mm<sup>2</sup>, AWG: 28 - 12, nominal current: 24 A, nom. voltage: 500 V, width: 31.2 mm, color: gray

---

#### Plug - SP 2,5/ 7 - 3040313



Plug, number of positions: 7, connection method: Spring-cage connection, cross section: 0.08 mm<sup>2</sup>- 4 mm<sup>2</sup>, AWG: 28 - 12, nominal current: 24 A, nom. voltage: 500 V, width: 36.4 mm, color: gray

---

## Ground modular terminal block - UT 2,5/1P-PE - 3045033

### Accessories

#### Plug - SP 2,5/ 8 - 3040326



Plug, number of positions: 8, connection method: Spring-cage connection, cross section: 0.08 mm<sup>2</sup>- 4 mm<sup>2</sup>, AWG: 28 - 12, nominal current: 24 A, nom. voltage: 500 V, width: 41.6 mm, color: gray

---

#### Plug - SP 2,5/ 9 - 3040339



Plug, number of positions: 9, connection method: Spring-cage connection, cross section: 0.08 mm<sup>2</sup>- 4 mm<sup>2</sup>, AWG: 28 - 12, nominal current: 24 A, nom. voltage: 500 V, width: 46.8 mm, color: gray

---

#### Plug - SP 2,5/10 - 3040342



Plug, number of positions: 10, connection method: Spring-cage connection, cross section: 0.08 mm<sup>2</sup>- 4 mm<sup>2</sup>, AWG: 28 - 12, nominal current: 24 A, nom. voltage: 500 V, width: 52 mm, color: gray

---

#### Plug - SP 2,5/11 - 3040355



Plug, number of positions: 11, connection method: Spring-cage connection, cross section: 0.08 mm<sup>2</sup>- 4 mm<sup>2</sup>, AWG: 28 - 12, nominal current: 24 A, nom. voltage: 500 V, width: 57.2 mm, color: gray

---

#### Plug - SP 2,5/12 - 3040368



Plug, number of positions: 12, connection method: Spring-cage connection, cross section: 0.08 mm<sup>2</sup>- 4 mm<sup>2</sup>, AWG: 28 - 12, nominal current: 24 A, nom. voltage: 500 V, width: 62.4 mm, color: gray

---

## Ground modular terminal block - UT 2,5/1P-PE - 3045033

### Accessories

Plug - SP 2,5/13 - 3040371



Plug, number of positions: 13, connection method: Spring-cage connection, cross section: 0.08 mm<sup>2</sup>- 4 mm<sup>2</sup>, AWG: 28 - 12, nominal current: 24 A, nom. voltage: 500 V, width: 67.6 mm, color: gray

---

Plug - SP 2,5/14 - 3040384



Plug, number of positions: 14, connection method: Spring-cage connection, cross section: 0.08 mm<sup>2</sup>- 4 mm<sup>2</sup>, AWG: 28 - 12, nominal current: 24 A, nom. voltage: 500 V, width: 72.8 mm, color: gray

---

Plug - SP 2,5/15 - 3040397



Plug, number of positions: 15, connection method: Spring-cage connection, cross section: 0.08 mm<sup>2</sup>- 4 mm<sup>2</sup>, AWG: 28 - 12, nominal current: 24 A, nom. voltage: 500 V, width: 78 mm, color: gray

---

Plug - SP 2,5/ 1 BU - 3040698



Plug, number of positions: 1, connection method: Spring-cage connection, cross section: 0.08 mm<sup>2</sup>- 4 mm<sup>2</sup>, AWG: 28 - 12, nominal current: 24 A, nom. voltage: 500 V, width: 5.2 mm, color: blue

---

Plug - SP 2,5/ 1 GNYE - 3040708



Plug, number of positions: 1, connection method: Spring-cage connection, cross section: 0.08 mm<sup>2</sup>- 4 mm<sup>2</sup>, AWG: 28 - 12, nominal current: 24 A, nom. voltage: 500 V, width: 5.2 mm, color: green-yellow

---

## Ground modular terminal block - UT 2,5/1P-PE - 3045033

### Accessories

Plug - SPB 2,5/ 1 - 3040106



Plug, number of positions: 1, connection method: Spring-cage connection, cross section: 0.08 mm<sup>2</sup>- 4 mm<sup>2</sup>, AWG: 28 - 12, nominal current: 24 A, nom. voltage: 500 V, width: 5.2 mm, color: gray

---

Plug - SPB 2,5/ 2 - 3040119



Plug, number of positions: 2, connection method: Spring-cage connection, cross section: 0.08 mm<sup>2</sup>- 4 mm<sup>2</sup>, AWG: 28 - 12, nominal current: 24 A, nom. voltage: 500 V, width: 10.4 mm, color: gray

---

Plug - SPB 2,5/ 3 - 3040122



Plug, number of positions: 3, connection method: Spring-cage connection, cross section: 0.08 mm<sup>2</sup>- 4 mm<sup>2</sup>, AWG: 28 - 12, nominal current: 24 A, nom. voltage: 500 V, width: 15.6 mm, color: gray

---

Plug - SPB 2,5/ 4 - 3040135



Plug, number of positions: 4, connection method: Spring-cage connection, cross section: 0.08 mm<sup>2</sup>- 4 mm<sup>2</sup>, AWG: 28 - 12, nominal current: 24 A, nom. voltage: 500 V, width: 20.8 mm, color: gray

---

Plug - SPB 2,5/ 5 - 3040143



Plug, number of positions: 5, connection method: Spring-cage connection, cross section: 0.08 mm<sup>2</sup>- 4 mm<sup>2</sup>, AWG: 28 - 12, nominal current: 24 A, nom. voltage: 500 V, width: 26 mm, color: gray

---

## Ground modular terminal block - UT 2,5/1P-PE - 3045033

### Accessories

#### Plug - SPB 2,5/ 6 - 3040151



Plug, number of positions: 6, connection method: Spring-cage connection, cross section: 0.08 mm<sup>2</sup>- 4 mm<sup>2</sup>, AWG: 28 - 12, nominal current: 24 A, nom. voltage: 500 V, width: 31.2 mm, color: gray

---

#### Plug - SPB 2,5/ 7 - 3040164



Plug, number of positions: 7, connection method: Spring-cage connection, cross section: 0.08 mm<sup>2</sup>- 4 mm<sup>2</sup>, AWG: 28 - 12, nominal current: 24 A, nom. voltage: 500 V, width: 36.4 mm, color: gray

---

#### Plug - SPB 2,5/ 8 - 3040177



Plug, number of positions: 8, connection method: Spring-cage connection, cross section: 0.08 mm<sup>2</sup>- 4 mm<sup>2</sup>, AWG: 28 - 12, nominal current: 24 A, nom. voltage: 500 V, width: 41.6 mm, color: gray

---

#### Plug - SPB 2,5/ 9 - 3040180



Plug, number of positions: 9, connection method: Spring-cage connection, cross section: 0.08 mm<sup>2</sup>- 4 mm<sup>2</sup>, AWG: 28 - 12, nominal current: 24 A, nom. voltage: 500 V, width: 46.8 mm, color: gray

---

#### Plug - SPB 2,5/10 - 3040193



Plug, number of positions: 10, connection method: Spring-cage connection, cross section: 0.08 mm<sup>2</sup>- 4 mm<sup>2</sup>, AWG: 28 - 12, nominal current: 24 A, nom. voltage: 500 V, width: 52 mm, color: gray

---

## Ground modular terminal block - UT 2,5/1P-PE - 3045033

### Accessories

#### Plug - SPB 2,5/11 - 3040203



Plug, number of positions: 11, connection method: Spring-cage connection, cross section: 0.08 mm<sup>2</sup>- 4 mm<sup>2</sup>, AWG: 28 - 12, nominal current: 24 A, nom. voltage: 500 V, width: 57.2 mm, color: gray

---

#### Plug - SPB 2,5/12 - 3040216



Plug, number of positions: 12, connection method: Spring-cage connection, cross section: 0.08 mm<sup>2</sup>- 4 mm<sup>2</sup>, AWG: 28 - 12, nominal current: 24 A, nom. voltage: 500 V, width: 62.4 mm, color: gray

---

#### Plug - SPB 2,5/13 - 3040229



Plug, number of positions: 13, connection method: Spring-cage connection, cross section: 0.08 mm<sup>2</sup>- 4 mm<sup>2</sup>, AWG: 28 - 12, nominal current: 24 A, nom. voltage: 500 V, width: 67.6 mm, color: gray

---

#### Plug - SPB 2,5/14 - 3040232



Plug, number of positions: 14, connection method: Spring-cage connection, cross section: 0.08 mm<sup>2</sup>- 4 mm<sup>2</sup>, AWG: 28 - 12, nominal current: 24 A, nom. voltage: 500 V, width: 72.8 mm, color: gray

---

#### Plug - SPB 2,5/15 - 3040245



Plug, number of positions: 15, connection method: Spring-cage connection, cross section: 0.08 mm<sup>2</sup>- 4 mm<sup>2</sup>, AWG: 28 - 12, nominal current: 24 A, nom. voltage: 500 V, width: 78 mm, color: gray

---

## Ground modular terminal block - UT 2,5/1P-PE - 3045033

### Accessories

Plug - SPB 2,5/ 1 BU - 3040724



Plug, number of positions: 1, connection method: Spring-cage connection, cross section: 0.08 mm<sup>2</sup>- 4 mm<sup>2</sup>, AWG: 28 - 12, nominal current: 24 A, nom. voltage: 500 V, width: 5.2 mm, color: blue

---

Plug - SPB 2,5/ 1 GNYE - 3040711



Plug, number of positions: 1, connection method: Spring-cage connection, cross section: 0.08 mm<sup>2</sup>- 4 mm<sup>2</sup>, AWG: 28 - 12, nominal current: 24 A, nom. voltage: 500 V, width: 5.2 mm, color: green-yellow

---

Plug - UPBV 2,5/ 1 - 3045145



Plug, number of positions: 1, connection method: Screw connection, cross section: 0.14 mm<sup>2</sup>- 4 mm<sup>2</sup>, AWG: 26 - 12, nominal current: 24 A, nom. voltage: 500 V, width: 5.2 mm, color: gray

---

Plug - UPBV 2,5/ 2 - 3045402



Plug, number of positions: 2, connection method: Screw connection, cross section: 0.14 mm<sup>2</sup>- 4 mm<sup>2</sup>, AWG: 26 - 12, nominal current: 24 A, nom. voltage: 500 V, width: 10.4 mm, color: gray

---

Plug - UPBV 2,5/ 3 - 3045415



Plug, number of positions: 3, connection method: Screw connection, cross section: 0.14 mm<sup>2</sup>- 4 mm<sup>2</sup>, AWG: 26 - 12, nominal current: 24 A, nom. voltage: 500 V, width: 15.6 mm, color: gray

---

## Ground modular terminal block - UT 2,5/1P-PE - 3045033

### Accessories

Plug - UPBV 2,5/ 4 - 3045428



Plug, number of positions: 4, connection method: Screw connection, cross section: 0.14 mm<sup>2</sup>- 4 mm<sup>2</sup>, AWG: 26 - 12, nominal current: 24 A, nom. voltage: 500 V, width: 20.8 mm, color: gray

---

Plug - UPBV 2,5/ 5 - 3045431



Plug, number of positions: 5, connection method: Screw connection, cross section: 0.14 mm<sup>2</sup>- 4 mm<sup>2</sup>, AWG: 26 - 12, nominal current: 24 A, nom. voltage: 500 V, width: 26 mm, color: gray

---

Plug - UPBV 2,5/ 6 - 3045444



Plug, number of positions: 6, connection method: Screw connection, cross section: 0.14 mm<sup>2</sup>- 4 mm<sup>2</sup>, AWG: 26 - 12, nominal current: 24 A, nom. voltage: 500 V, width: 31.2 mm, color: gray

---

Plug - UPBV 2,5/ 7 - 3045457



Plug, number of positions: 7, connection method: Screw connection, cross section: 0.14 mm<sup>2</sup>- 4 mm<sup>2</sup>, AWG: 26 - 12, nominal current: 24 A, nom. voltage: 500 V, width: 36.4 mm, color: gray

---

Plug - UPBV 2,5/ 8 - 3045460



Plug, number of positions: 8, connection method: Screw connection, cross section: 0.14 mm<sup>2</sup>- 4 mm<sup>2</sup>, AWG: 26 - 12, nominal current: 24 A, nom. voltage: 500 V, width: 41.6 mm, color: gray

---



## Ground modular terminal block - UT 2,5/1P-PE - 3045033

### Accessories

#### Plug - UPBV 2,5/ 9 - 3045473



Plug, number of positions: 9, connection method: Screw connection, cross section: 0.14 mm<sup>2</sup>- 4 mm<sup>2</sup>, AWG: 26 - 12, nominal current: 24 A, nom. voltage: 500 V, width: 46.8 mm, color: gray

---

#### Plug - UPBV 2,5/10 - 3045499



Plug, number of positions: 10, connection method: Screw connection, cross section: 0.14 mm<sup>2</sup>- 4 mm<sup>2</sup>, AWG: 26 - 12, nominal current: 24 A, nom. voltage: 500 V, width: 52 mm, color: gray

---

#### Plug - UPBV 2,5/11 - 3045509



Plug, number of positions: 11, connection method: Screw connection, cross section: 0.14 mm<sup>2</sup>- 4 mm<sup>2</sup>, AWG: 26 - 12, nominal current: 24 A, nom. voltage: 500 V, width: 57.2 mm, color: gray

---

#### Plug - UPBV 2,5/12 - 3045512



Plug, number of positions: 12, connection method: Screw connection, cross section: 0.14 mm<sup>2</sup>- 4 mm<sup>2</sup>, AWG: 26 - 12, nominal current: 24 A, nom. voltage: 500 V, width: 62.4 mm, color: gray

---

#### Plug - UPBV 2,5/13 - 3045525



Plug, number of positions: 13, connection method: Screw connection, cross section: 0.14 mm<sup>2</sup>- 4 mm<sup>2</sup>, AWG: 26 - 12, nominal current: 24 A, nom. voltage: 500 V, width: 67.6 mm, color: gray

---

## Ground modular terminal block - UT 2,5/1P-PE - 3045033

### Accessories

Plug - UPBV 2,5/14 - 3045538



Plug, number of positions: 14, connection method: Screw connection, cross section: 0.14 mm<sup>2</sup>- 4 mm<sup>2</sup>, AWG: 26 - 12, nominal current: 24 A, nom. voltage: 500 V, width: 72.8 mm, color: gray

---

Plug - UPBV 2,5/15 - 3045541



Plug, number of positions: 15, connection method: Screw connection, cross section: 0.14 mm<sup>2</sup>- 4 mm<sup>2</sup>, AWG: 26 - 12, nominal current: 24 A, nom. voltage: 500 V, width: 78 mm, color: gray

---

Plug - UPBV 2,5/ 1 BU - 3045240



Plug, number of positions: 1, connection method: Screw connection, cross section: 0.14 mm<sup>2</sup>- 4 mm<sup>2</sup>, AWG: 26 - 12, nominal current: 24 A, nom. voltage: 500 V, width: 5.2 mm, color: blue

---

Plug - UPBV 2,5/ 1 GNYE - 3045253



Plug, number of positions: 1, connection method: Screw connection, cross section: 0.14 mm<sup>2</sup>- 4 mm<sup>2</sup>, AWG: 26 - 12, nominal current: 24 A, nom. voltage: 500 V, width: 5.2 mm, color: green-yellow

---

Plug - UPBV 2,5/ 1-L - 3045318



Plug, number of positions: 1, connection method: Screw connection, cross section: 0.14 mm<sup>2</sup>- 4 mm<sup>2</sup>, AWG: 26 - 12, nominal current: 24 A, nom. voltage: 500 V, width: 5.2 mm, color: gray

---

## Ground modular terminal block - UT 2,5/1P-PE - 3045033

### Accessories

Plug - UPBV 2,5/ 1-L BU - 3045321



Plug, number of positions: 1, connection method: Screw connection, cross section: 0.14 mm<sup>2</sup>- 4 mm<sup>2</sup>, AWG: 26 - 12, nominal current: 24 A, nom. voltage: 500 V, width: 5.2 mm, color: blue

---

Plug - UPBV 2,5/ 1-L GNYE - 3045334



Plug, number of positions: 1, connection method: Screw connection, cross section: 0.14 mm<sup>2</sup>- 4 mm<sup>2</sup>, AWG: 26 - 12, nominal current: 24 A, nom. voltage: 500 V, width: 5.2 mm, color: green-yellow

---

Plug - UPBV 2,5/ 1-M - 3045347



Plug, number of positions: 1, connection method: Screw connection, cross section: 0.14 mm<sup>2</sup>- 4 mm<sup>2</sup>, AWG: 26 - 12, nominal current: 24 A, nom. voltage: 500 V, width: 5.2 mm, color: gray

---

Plug - UPBV 2,5/ 1-M BU - 3045350



Plug, number of positions: 1, connection method: Screw connection, cross section: 0.14 mm<sup>2</sup>- 4 mm<sup>2</sup>, AWG: 26 - 12, nominal current: 24 A, nom. voltage: 500 V, width: 5.2 mm, color: blue

---

Plug - UPBV 2,5/ 1-M GNYE - 3045363



Plug, number of positions: 1, connection method: Screw connection, cross section: 0.14 mm<sup>2</sup>- 4 mm<sup>2</sup>, AWG: 26 - 12, nominal current: 24 A, nom. voltage: 500 V, width: 5.2 mm, color: green-yellow

---

## Ground modular terminal block - UT 2,5/1P-PE - 3045033

### Accessories

Plug - UPBV 2,5/ 1-R - 3045376



Plug, number of positions: 1, connection method: Screw connection, cross section: 0.14 mm<sup>2</sup>- 4 mm<sup>2</sup>, AWG: 26 - 12, nominal current: 24 A, nom. voltage: 500 V, width: 5.2 mm, color: gray

---

Plug - UPBV 2,5/ 1-R BU - 3045389



Plug, number of positions: 1, connection method: Screw connection, cross section: 0.14 mm<sup>2</sup>- 4 mm<sup>2</sup>, AWG: 26 - 12, nominal current: 24 A, nom. voltage: 500 V, width: 5.2 mm, color: blue

---

Plug - UPBV 2,5/ 1-R GNYE - 3045392



Plug, number of positions: 1, connection method: Screw connection, cross section: 0.14 mm<sup>2</sup>- 4 mm<sup>2</sup>, AWG: 26 - 12, nominal current: 24 A, nom. voltage: 500 V, width: 5.2 mm, color: green-yellow

---

---

Phoenix Contact 2020 © - all rights reserved  
<http://www.phoenixcontact.com>

PHOENIX CONTACT GmbH & Co. KG  
Flachsmarktstr. 8  
32825 Blomberg  
Germany  
Tel. +49 5235 300  
Fax +49 5235 3 41200  
<http://www.phoenixcontact.com>

# Mouser Electronics

Authorized Distributor

Click to View Pricing, Inventory, Delivery & Lifecycle Information:

[Phoenix Contact:](#)

[3045033](#)