

Plug - SP 2,5/ 1-M OG - 3043886

Please be informed that the data shown in this PDF Document is generated from our Online Catalog. Please find the complete data in the user's documentation. Our General Terms of Use for Downloads are valid (<http://phoenixcontact.com/download>)



Plug, number of positions: 1, connection method: Spring-cage connection, cross section: 0.08 mm²- 4 mm², AWG: 28 - 12, nominal current: 24 A, nom. voltage: 500 V, width: 5.2 mm, color: orange

The figure shows versions of the SP 2,5/1-... connector in various colors

Product Description

Connector element center, left housing with engagement pin, right opened without cover

Your advantages

- Cable housing can be snapped on to the plugs, see figure below
- The plug with spring-cage connection is assembled directly on site by snapping together single-position plug elements
- The ST-COMBI plugs for self-assembly provide solutions that users can implement themselves



Key Commercial Data

Packing unit	50 pc
Minimum order quantity	50 pc
GTIN	 4 017918 991890
GTIN	4017918991890

Technical data

General

Number of positions	1
Nominal cross section	2.5 mm ²
Color	orange
Insulating material	PA
Flammability rating according to UL 94	V0
Rated surge voltage	6 kV
Degree of pollution	3
Overvoltage category	III

Plug - SP 2,5/ 1-M OG - 3043886

Technical data

General

Insulating material group	I
Maximum power dissipation for nominal condition	0.77 W
Maximum load current	24 A (with 4 mm ² conductor cross section)
Nominal current I _N	24 A
Nominal voltage U _N	500 V

Dimensions

Width	5.2 mm
Length	15.8 mm
Height	39 mm
	24 mm
Pitch	5.2 mm

Connection data

Connection method	Spring-cage connection
Stripping length	8 mm ... 10 mm
Connection in acc. with standard	IEC 61984
Conductor cross section solid min.	0.08 mm ²
Conductor cross section solid max.	4 mm ²
Conductor cross section AWG min.	28
Conductor cross section AWG max.	12
Conductor cross section flexible min.	0.08 mm ²
Conductor cross section flexible max.	2.5 mm ²
Min. AWG conductor cross section, flexible	28
Max. AWG conductor cross section, flexible	14
Conductor cross section flexible, with ferrule without plastic sleeve min.	0.14 mm ²
Conductor cross section flexible, with ferrule without plastic sleeve max.	2.5 mm ²
Conductor cross section flexible, with ferrule with plastic sleeve min.	0.14 mm ²
Conductor cross section flexible, with ferrule with plastic sleeve max.	2.5 mm ²
Two conductors with the same cross section, flexible, with TWIN ferrules, with plastic sleeve, maximum	0.5 mm ²
Internal cylindrical gage	A3

Standards and Regulations

Connection in acc. with standard	CSA
	IEC 61984
Flammability rating according to UL 94	V0

Environmental Product Compliance

China RoHS	Environmentally friendly use period: unlimited = EFUP-e
	No hazardous substances above threshold values

Drawings

Plug - SP 2,5/ 1-M OG - 3043886

Schematic diagram

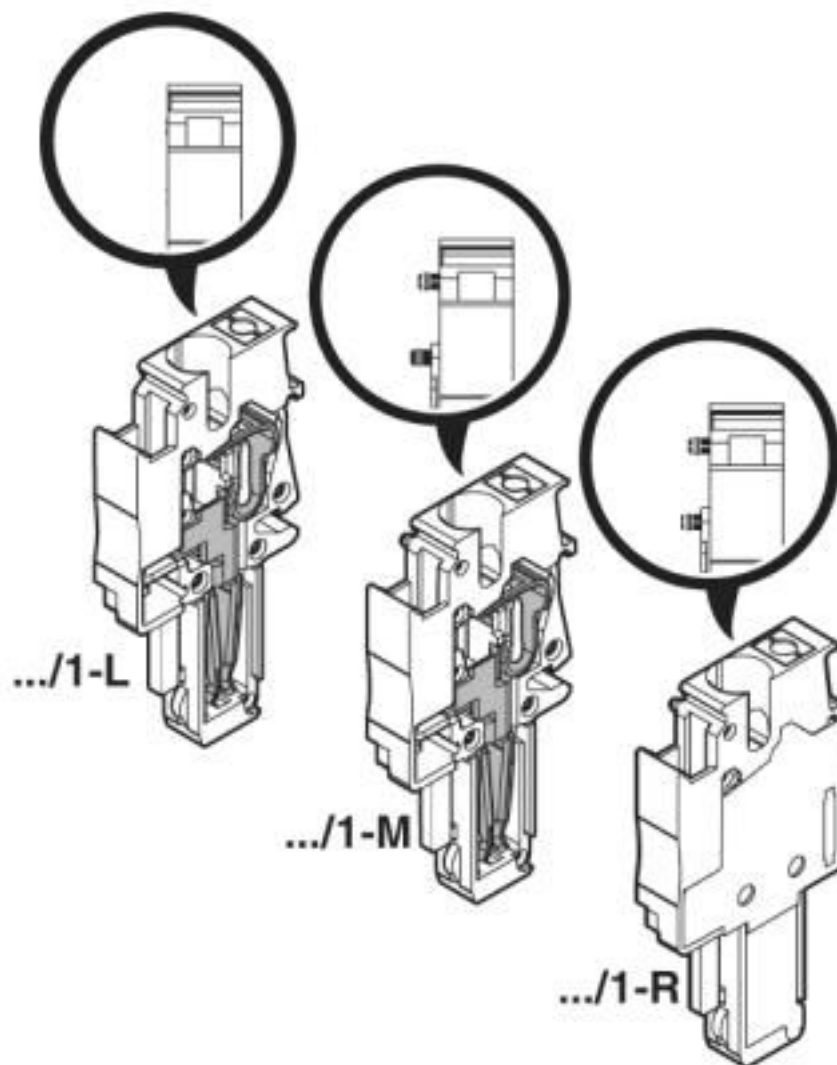

Plug - SP 2,5/ 1-M OG - 3043886

Diagram

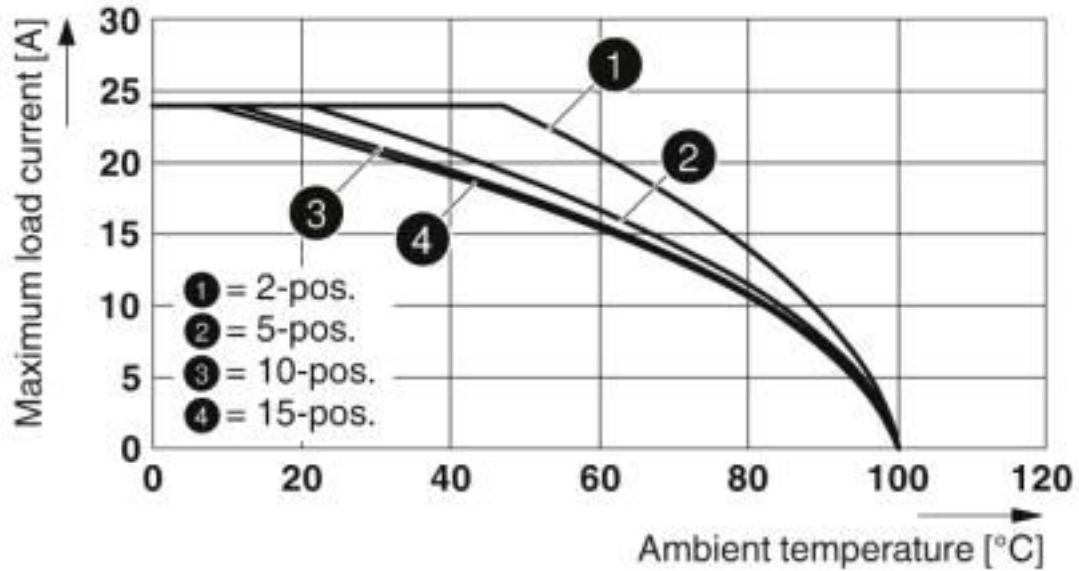

Derating curve for ST 2,5/ 1P, ST 2,5/ 2P, ST 2,5-TWIN/ 1P and for all plug versions SP...

Diagram

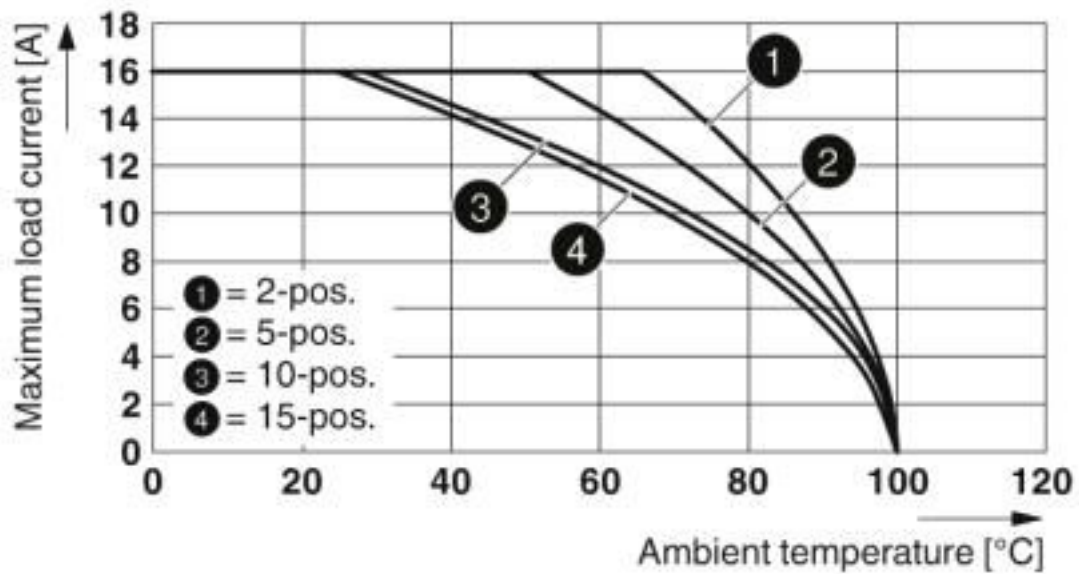

Derating curve for ST 2,5-TWIN-MT/1P, ST 2,5-TWIN-TG/1P and for all plug versions SP...

Plug - SP 2,5/ 1-M OG - 3043886

Diagram

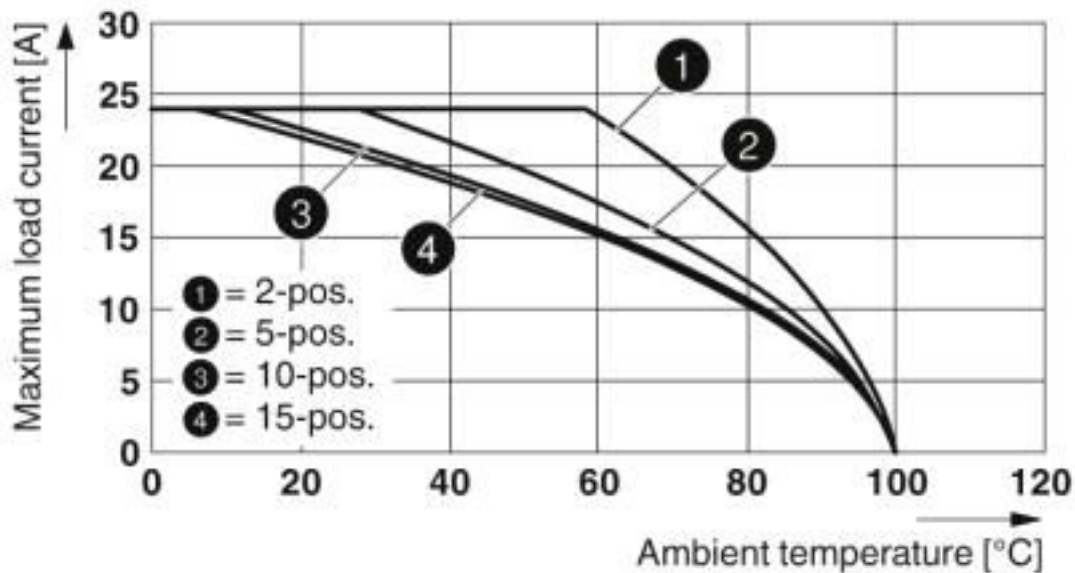

Derating curve for ST 2,5-QUATTRO/2P, ST 2,5-QUATTRO/4P and for all plug versions SP...

Diagram

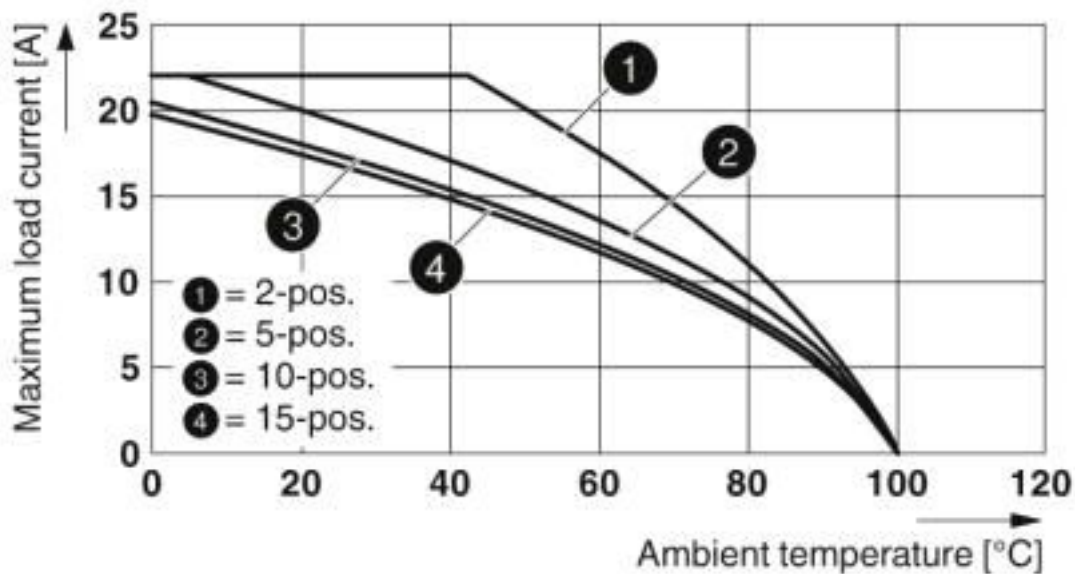

Derating curve for STTB 2,5/ 2P, STTB 2,5/ 2P-PV and for all plug versions SP...

Plug - SP 2,5/ 1-M OG - 3043886

Diagram

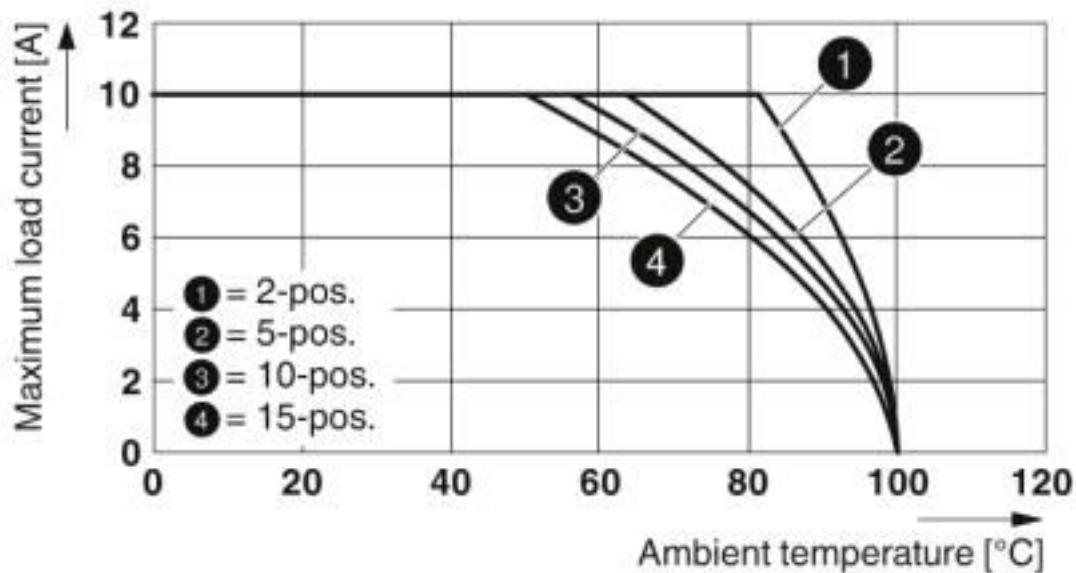

Derating curve for ST 2,5-4L/1P, ST 2,5-4L/2P and for all plug versions SP...

Circuit diagram



Classifications

eCl@ss

eCl@ss 10.0.1	27141151
eCl@ss 4.0	27260700
eCl@ss 4.1	27260700
eCl@ss 5.0	27260700
eCl@ss 5.1	27260700
eCl@ss 6.0	27141100
eCl@ss 7.0	27141151
eCl@ss 8.0	27141151
eCl@ss 9.0	27141151

ETIM

ETIM 2.0	EC000897
ETIM 3.0	EC000897
ETIM 4.0	EC002021
ETIM 5.0	EC002021
ETIM 6.0	EC002021

Plug - SP 2,5/ 1-M OG - 3043886

Classifications

ETIM

ETIM 7.0	EC002021
----------	----------

UNSPSC

UNSPSC 6.01	30211802
UNSPSC 7.0901	39121402
UNSPSC 11	39121402
UNSPSC 12.01	39121402
UNSPSC 13.2	39121402
UNSPSC 18.0	39121402
UNSPSC 19.0	39121402
UNSPSC 20.0	39121402
UNSPSC 21.0	39121402

Approvals

Approvals

Approvals

DNV GL / CSA / BV / UL Recognized / cUL Recognized / EAC / RS / EAC / cULus Recognized

Ex Approvals

Approval details

DNV GL		https://approvalfinder.dnvgl.com/	TAE00001CS
--------	--	---	------------

CSA		http://www.csagroup.org/services-industries/product-listing/	13631
	B	C	D
Nominal voltage UN	300 V	300 V	600 V
Nominal current IN	20 A	20 A	5 A
mm ² /AWG/kcmil	24-12	24-12	24-12

BV		http://www.veristar.com/portal/veristarinfo/generalinfo/approved/approvedProducts/equipmentAndMaterials	27721/B0 BV
----	--	---	-------------

Plug - SP 2,5/ 1-M OG - 3043886

Approvals

UL Recognized		http://database.ul.com/cgi-bin/XYV/template/LISEXT/1FRAME/index.htm	FILE E 60425
	B	C	D
Nominal voltage UN	300 V	300 V	600 V
Nominal current IN	20 A	20 A	5 A
mm ² /AWG/kcmil	26-12	26-12	26-12

cUL Recognized		http://database.ul.com/cgi-bin/XYV/template/LISEXT/1FRAME/index.htm	FILE E 60425
	B	C	D
Nominal voltage UN	300 V	300 V	600 V
Nominal current IN	20 A	20 A	5 A
mm ² /AWG/kcmil	26-12	26-12	26-12

EAC		RU C- DE.A*30.B.01742
-----	--	--------------------------

RS		http://www.rs-head.spb.ru/en/index.php	17.00013.272
----	--	---	--------------

EAC		RU C- DE.BL08.B.00511
-----	--	--------------------------

cULus Recognized	
------------------	--

Accessories

Accessories

Labeled terminal marker

Zack Marker strip, flat - ZBF 5 CUS - 0825025



Zack Marker strip, flat, can be ordered: Strip, white, labeled according to customer specifications, mounting type: snap into flat marker groove, for terminal block width: 5 mm, lettering field size: 5.15 x 5.15 mm, Number of individual labels: 10

Plug - SP 2,5/ 1-M OG - 3043886

Accessories

Zack Marker strip, flat - ZBF 5,LGS:FORTL.ZAHLEN - 0808671



Zack Marker strip, flat, Strip, white, labeled, printed horizontally: consecutive numbers 1 ... 10, 11 ... 20, etc. up to 491 ... 500, mounting type: snap into flat marker groove, for terminal block width: 5 mm, lettering field size: 5.15 x 5.15 mm, Number of individual labels: 10

Zack Marker strip, flat - ZBF 5,QR:FORTL.ZAHLEN - 0808697



Zack Marker strip, flat, Strip, white, labeled, Printed vertically: consecutive numbers 1 ... 10, 11 ... 20, etc. up to 91 ... 100, mounting type: snap into flat marker groove, for terminal block width: 5 mm, lettering field size: 5.15 x 5.15 mm, Number of individual labels: 10

Zack Marker strip, flat - ZBF 5,LGS:GERADE ZAHLEN - 0810821



Zack Marker strip, flat, Strip, white, labeled, printed horizontally: consecutive numbers 2 ... 20, 22 ... 40, etc. up to 82 ... 100, mounting type: snap into flat marker groove, for terminal block width: 5 mm, lettering field size: 5.15 x 5.15 mm, Number of individual labels: 10

Zack Marker strip, flat - ZBF 5,LGS:UNGERADE ZAHLEN - 0810863



Zack Marker strip, flat, Strip, white, labeled, printed horizontally: Odd numbers 1 - 19, 21 - 39, etc. up to 81 - 99, mounting type: snap into flat marker groove, for terminal block width: 5 mm, lettering field size: 5.15 x 5.15 mm, Number of individual labels: 10

Marker for terminal blocks - UC-TMF 5 CUS - 0824638



Marker for terminal blocks, can be ordered: by sheet, white, labeled according to customer specifications, mounting type: snap into flat marker groove, for terminal block width: 5.2 mm, lettering field size: 4.6 x 5.1 mm, Number of individual labels: 96

Plug - SP 2,5/ 1-M OG - 3043886

Accessories

Marker for terminal blocks - UCT-TMF 5 CUS - 0829658



Marker for terminal blocks, can be ordered: by sheet, white, labeled according to customer specifications, mounting type: snap into flat marker groove, for terminal block width: 5.2 mm, lettering field size: 4.4 x 4.7 mm, Number of individual labels: 72

Marker pen

Marker pen - B-STIFT - 1051993



Marker pen, for manual labeling of unprinted Zack strips, smear-proof and waterproof, line thickness 0.5 mm

Marker pen - X-PEN 0,35 - 0811228



Marker pen without ink cartridge, for manual labeling of markers, labeling extremely wipe-proof, line thickness 0.35 mm

Mounting material

Latching - PR - 3040559



Latching, length: 29.8 mm, width: 4.4 mm, number of positions: 1, color: orange

Latching - PR/2 - 3040630



Latching, length: 29.8 mm, width: 10 mm, number of positions: 2, color: orange

Plug - SP 2,5/ 1-M OG - 3043886

Accessories

Latching - PRT/2 - 3040631



Latching, can only be released using a screwdriver, length: 23.2 mm, width: 9 mm, number of positions: 2, color: orange

Latching - PRZ - 3040614



Latching, length: 63.6 mm, width: 9.7 mm, number of positions: 2, color: orange

Screwdriver tools

Actuation tool - ST-BW - 1207608



Actuation tool, for all 2.5 mm² - 4.0 mm² spring-cages

Shield connection

Shield connection clamp - PSH 3- 6 - 3040591



Shield connection clamp, color: black

Shield connection clamp - PSH 5-10 - 3040601



Shield connection clamp, color: black

Strain relief

Plug - SP 2,5/ 1-M OG - 3043886

Accessories

Strain relief - PZ/2 - 3040627



Strain relief, length: 48.7 mm, width: 9.3 mm, number of positions: 2, color: black

Strain relief - PZ/4 - 3040643



Strain relief, length: 48.7 mm, width: 19.6 mm, number of positions: 4, color: black

Terminal marking

Zack Marker strip, flat - ZBF 5:UNBEDRUCKT - 0808642



Zack Marker strip, flat, Strip, white, unlabeled, can be labeled with: PLOTMARK, CMS-P1-PLOTTER, mounting type: snap into flat marker groove, for terminal block width: 5 mm, lettering field size: 5.1 x 5.2 mm, Number of individual labels: 10

Marker for terminal blocks - UC-TMF 5 - 0818153



Marker for terminal blocks, Sheet, white, unlabeled, can be labeled with: BLUEMARK ID COLOR, BLUEMARK ID, BLUEMARK CLED, PLOTMARK, CMS-P1-PLOTTER, mounting type: snap into flat marker groove, for terminal block width: 5.2 mm, lettering field size: 4.6 x 5.1 mm, Number of individual labels: 96

Marker for terminal blocks - UCT-TMF 5 - 0828744



Marker for terminal blocks, Sheet, white, unlabeled, can be labeled with: TOPMARK NEO, TOPMARK LASER, BLUEMARK ID COLOR, BLUEMARK ID, BLUEMARK CLED, THERMOMARK PRIME, THERMOMARK CARD 2.0, THERMOMARK CARD, mounting type: snap into flat marker groove, for terminal block width: 5.2 mm, lettering field size: 4.4 x 4.7 mm, Number of individual labels: 72

Phoenix Contact 2020 © - all rights reserved
<http://www.phoenixcontact.com>

PHOENIX CONTACT GmbH & Co. KG
Flachsmarktstr. 8
32825 Blomberg
Germany
Tel. +49 5235 300
Fax +49 5235 3 41200
<http://www.phoenixcontact.com>

Mouser Electronics

Authorized Distributor

Click to View Pricing, Inventory, Delivery & Lifecycle Information:

[Phoenix Contact:](#)

[3043886](#)