

Relay Module - PLC-RSC-120UC/ 1/SEN - 2966249

Please be informed that the data shown in this PDF Document is generated from our Online Catalog. Please find the complete data in the user's documentation. Our General Terms of Use for Downloads are valid (<http://phoenixcontact.com/download>)



PLC-INTERFACE for input functions, consisting of PLC-BSC.../SEN basic terminal block with screw connection and plug-in miniature relay with power contact, for mounting on DIN rail NS 35/7,5, 1 N/O contact, input voltage 120 V AC/110 DC



Key Commercial Data

Packing unit	10 pc
GTIN	 4 017918 130954
GTIN	4017918130954
Sales Key	08

Technical data

Note

Utilization restriction	EMC: class A product, see manufacturer's declaration in the download area
-------------------------	---

Dimensions

Width	6.2 mm
Height	80 mm
Depth	94 mm

Ambient conditions

Ambient temperature (operation)	-25 °C ... 55 °C
Ambient temperature (storage/transport)	-40 °C ... 85 °C
Degree of protection	IP20 (Relay base)

Coil side

Nominal input voltage U_N	120 V AC
	110 V DC
Typical input current at U_N	3.5 mA
Typical response time	6 ms

Relay Module - PLC-RSC-120UC/ 1/SEN - 2966249

Technical data

Coil side

Typical release time	15 ms
Protective circuit	Bridge rectifier
Operating voltage display	yes
Power dissipation for nominal condition	0.42 W

Contact side

Contact type	1 N/O contact
Type of switch contact	Single contact
Contact material	AgSnO
Maximum switching voltage	250 V AC/DC (The separating plate PLC-ATP should be installed for voltages larger than 250 V (L1, L2, L3) between identical terminal blocks in adjacent modules. Potential bridging is then carried out with FBST 8-PLC... or ...FBST 500...)
Minimum switching voltage	12 V AC/DC
Min. switching current	10 mA
Maximum inrush current	on request
Limiting continuous current	6 A
Interrupting rating (ohmic load) max.	140 W (at 24 V DC)
	20 W (at 48 V DC)
	18 W (at 60 V DC)
	23 W (at 110 V DC)
	40 W (at 220 V DC)
	1500 VA (for 250 V AC)

General

Test voltage relay winding/relay contact	4 kV AC (50 Hz, 1 min.)
Operating mode	100% operating factor
Flammability rating according to UL 94	V0 (Housing)
Mechanical service life	2x 10 ⁷ cycles
Mounting position	any
Assembly instructions	In rows with zero spacing

Connection data

Connection name	Coil side
Connection method	Screw connection
Stripping length	8 mm
Screw thread	M3
Conductor cross section solid	0.14 mm ² ... 2.5 mm ²
Conductor cross section flexible	0.14 mm ² ... 2.5 mm ²
	0.2 mm ² ... 2.5 mm ² (Single ferrule)
	2x 0.5 mm ² ... 1.5 mm ² (TWIN ferrule)
Conductor cross section AWG	26 ... 14

Connection data 2

Relay Module - PLC-RSC-120UC/ 1/SEN - 2966249

Technical data

Connection data 2

Connection name	Contact side
Connection method	Screw connection
Stripping length	8 mm
Screw thread	M3
Conductor cross section solid	0.14 mm ² ... 2.5 mm ²
Conductor cross section flexible	0.14 mm ² ... 2.5 mm ²
	0.2 mm ² ... 2.5 mm ² (Single ferrule)
	2x 0.5 mm ² ... 1.5 mm ² (TWIN ferrule)
Conductor cross section AWG	26 ... 14

Standards and Regulations

Connection in acc. with standard	CUL
Designation	Standards/regulations
Standards/regulations	IEC 60664
	IEC 60664A
	DIN VDE 0110
	DIN EN 50178/VDE 0160 (in relevant parts)
	DIN EN 50178/VDE 0160
	IEC 60255/DIN VDE 0435 (in relevant parts)
Pollution degree	3
Overvoltage category	III

Environmental Product Compliance

REACH SVHC	Lead 7439-92-1
China RoHS	Environmentally Friendly Use Period = 50 years
	For details about hazardous substances go to tab "Downloads", Category "Manufacturer's declaration"

Drawings

Relay Module - PLC-RSC-120UC/ 1/SEN - 2966249

Circuit diagram

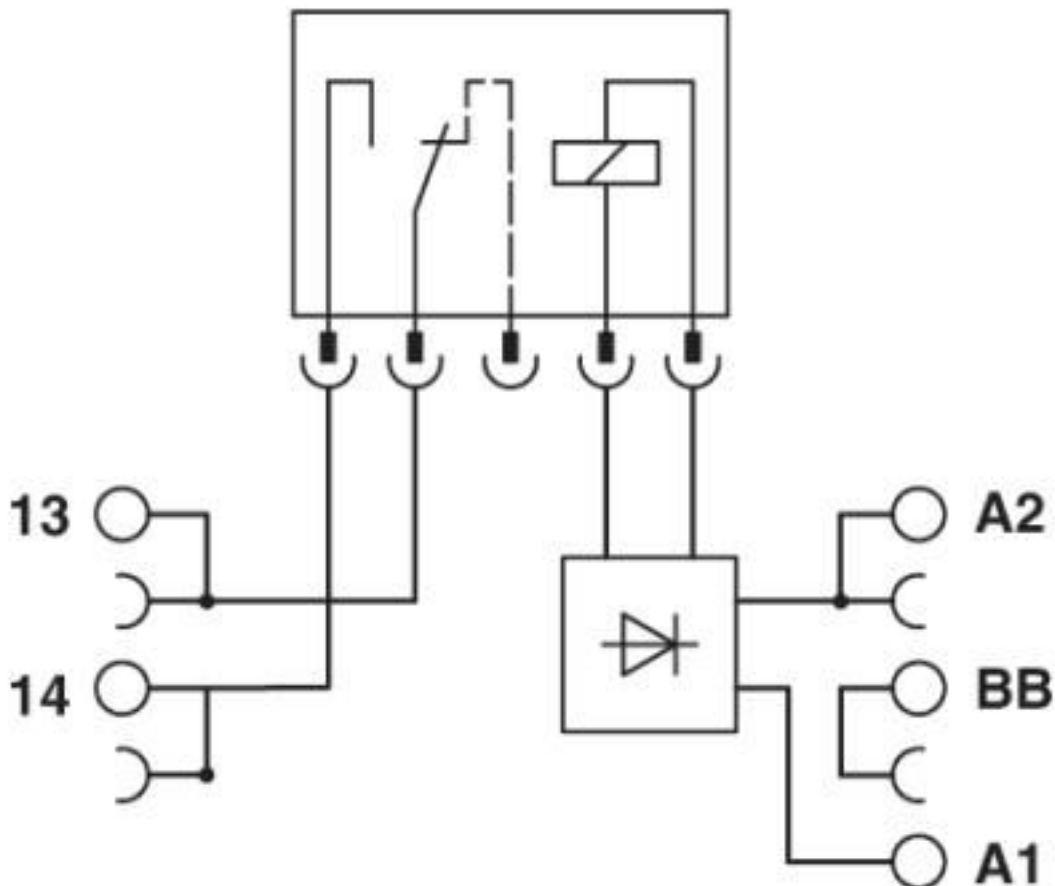

Classifications

eCl@ss

eCl@ss 10.0.1	27371601
eCl@ss 4.0	27371100
eCl@ss 4.1	27371100
eCl@ss 5.0	27371600
eCl@ss 5.1	27371600
eCl@ss 6.0	27371600
eCl@ss 7.0	27371601
eCl@ss 8.0	27371601
eCl@ss 9.0	27371601

ETIM

ETIM 2.0	EC001437
ETIM 3.0	EC001437
ETIM 4.0	EC001437
ETIM 5.0	EC001437

Relay Module - PLC-RSC-120UC/ 1/SEN - 2966249

Classifications

ETIM

ETIM 6.0	EC001437
ETIM 7.0	EC001437

UNSPSC

UNSPSC 6.01	30211916
UNSPSC 7.0901	39121515
UNSPSC 11	39121515
UNSPSC 12.01	39121515
UNSPSC 13.2	39122334
UNSPSC 18.0	39122334
UNSPSC 19.0	39122334
UNSPSC 20.0	39122334
UNSPSC 21.0	39122334

Approvals

Approvals

Approvals

PRS / UL Listed / UL Recognized / cUL Recognized / cUL Listed / RC FRT / DNV GL / EAC / EAC / cULus Recognized / cULus Listed

Ex Approvals

Approval details

PRS		http://www.prs.pl/	TE/2109/880590/16
-----	---	---	-------------------

UL Listed		http://database.ul.com/cgi-bin/XYV/template/LISEXT/1FRAME/index.htm	FILE E 172140
-----------	---	---	---------------

UL Recognized		http://database.ul.com/cgi-bin/XYV/template/LISEXT/1FRAME/index.htm	FILE E 238705
---------------	---	---	---------------

cUL Recognized		http://database.ul.com/cgi-bin/XYV/template/LISEXT/1FRAME/index.htm	FILE E 238705
----------------	---	---	---------------

Relay Module - PLC-RSC-120UC/ 1/SEN - 2966249

Approvals

cUL Listed		http://database.ul.com/cgi-bin/XYV/template/LISEXT/1FRAME/index.htm	FILE E 172140
------------	--	---	---------------

RC FRT			B.00094
--------	--	--	---------

DNV GL		https://approvalfinder.dnvgl.com/	TAE0000196-03
--------	--	---	---------------

EAC			TR_TS_D_00573_c
-----	--	--	-----------------

EAC			RU*C- DE.*08.B.00010
-----	--	--	-------------------------

cULus Recognized			
------------------	--	--	--

cULus Listed			
--------------	--	--	--

Accessories

Accessories

Bridge

Continuous plug-in bridge - FBST 500-PLC RD - 2966786



Continuous plug-in bridge, length: 500 mm, color: red

Relay Module - PLC-RSC-120UC/ 1/SEN - 2966249

Accessories

Continuous plug-in bridge - FBST 500-PLC BU - 2966692



Continuous plug-in bridge, length: 500 mm, color: blue

Continuous plug-in bridge - FBST 500-PLC GY - 2966838



Continuous plug-in bridge, length: 500 mm, color: gray

Single plug-in bridge - FBST 6-PLC RD - 2966236



Single plug-in bridge, length: 6 mm, number of positions: 2, color: red

Single plug-in bridge - FBST 6-PLC BU - 2966812



Single plug-in bridge, length: 6 mm, number of positions: 2, color: blue

Single plug-in bridge - FBST 6-PLC GY - 2966825



Single plug-in bridge, length: 6 mm, number of positions: 2, color: gray

Relay Module - PLC-RSC-120UC/ 1/SEN - 2966249

Accessories

Single plug-in bridge - FBST 8-PLC GY - 2967688



Single plug-in bridge, length: 8 mm, number of positions: 2, color: gray

Single plug-in bridge - FBST 14-PLC BK - 2967691



Single plug-in bridge, length: 14 mm, number of positions: 2, color: black

DIN rail

DIN rail perforated - NS 35/ 7,5 PERF 2000MM - 0801733



DIN rail perforated, Standard profile, width: 35 mm, height: 7.5 mm, acc. to EN 60715, material: Steel, galvanized, passivated with a thick layer, length: 2000 mm, color: silver

DIN rail, unperforated - NS 35/ 7,5 UNPERF 2000MM - 0801681



DIN rail, unperforated, Standard profile, width: 35 mm, height: 7.5 mm, acc. to EN 60715, material: Steel, galvanized, passivated with a thick layer, length: 2000 mm, color: silver

DIN rail perforated - NS 35/ 7,5 WH PERF 2000MM - 1204119



DIN rail perforated, Standard profile, width: 35 mm, height: 7.5 mm, acc. to EN 60715, material: Steel, Galvanized, white passivated, length: 2000 mm, color: silver

Relay Module - PLC-RSC-120UC/ 1/SEN - 2966249

Accessories

DIN rail, unperforated - NS 35/ 7,5 WH UNPERF 2000MM - 1204122



DIN rail, unperforated, Standard profile, width: 35 mm, height: 7.5 mm, acc. to EN 60715, material: Steel, Galvanized, white passivated, length: 2000 mm, color: silver

DIN rail, unperforated - NS 35/ 7,5 AL UNPERF 2000MM - 0801704



DIN rail, unperforated, Standard profile, width: 35 mm, height: 7.5 mm, acc. to EN 60715, material: Aluminum, uncoated, length: 2000 mm, color: silver

DIN rail perforated - NS 35/ 7,5 ZN PERF 2000MM - 1206421



DIN rail perforated, Standard profile, width: 35 mm, height: 7.5 mm, acc. to EN 60715, material: Steel, galvanized, length: 2000 mm, color: silver

DIN rail, unperforated - NS 35/ 7,5 ZN UNPERF 2000MM - 1206434



DIN rail, unperforated, Standard profile, width: 35 mm, height: 7.5 mm, acc. to EN 60715, material: Steel, galvanized, length: 2000 mm, color: silver

DIN rail, unperforated - NS 35/ 7,5 CU UNPERF 2000MM - 0801762



DIN rail, unperforated, Standard profile, width: 35 mm, height: 7.5 mm, acc. to EN 60715, material: Copper, uncoated, length: 2000 mm, color: copper-colored

Relay Module - PLC-RSC-120UC/ 1/SEN - 2966249

Accessories

End cap - NS 35/ 7,5 CAP - 1206560

DIN rail end piece, for DIN rail NS 35/7.5



DIN rail perforated - NS 35/15 PERF 2000MM - 1201730



DIN rail perforated, Standard profile, width: 35 mm, height: 15 mm, similar to EN 60715, material: Steel, galvanized, passivated with a thick layer, length: 2000 mm, color: silver

DIN rail, unperforated - NS 35/15 UNPERF 2000MM - 1201714

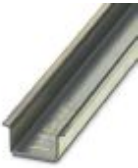

DIN rail, unperforated, Standard profile, width: 35 mm, height: 15 mm, similar to EN 60715, material: Steel, galvanized, passivated with a thick layer, length: 2000 mm, color: silver

DIN rail perforated - NS 35/15 WH PERF 2000MM - 0806602



DIN rail perforated, Standard profile, width: 35 mm, height: 15 mm, similar to EN 60715, material: Steel, Galvanized, white passivated, length: 2000 mm, color: silver

DIN rail, unperforated - NS 35/15 WH UNPERF 2000MM - 1204135



DIN rail, unperforated, Standard profile, width: 35 mm, height: 15 mm, similar to EN 60715, material: Steel, Galvanized, white passivated, length: 2000 mm, color: silver

Relay Module - PLC-RSC-120UC/ 1/SEN - 2966249

Accessories

DIN rail, unperforated - NS 35/15 AL UNPERF 2000MM - 1201756



DIN rail, unperforated, Standard profile, width: 35 mm, height: 15 mm, similar to EN 60715, material: Aluminum, uncoated, length: 2000 mm, color: silver

DIN rail perforated - NS 35/15 ZN PERF 2000MM - 1206599



DIN rail perforated, Standard profile, width: 35 mm, height: 15 mm, similar to EN 60715, material: Steel, galvanized, length: 2000 mm, color: silver

DIN rail, unperforated - NS 35/15 ZN UNPERF 2000MM - 1206586



DIN rail, unperforated, Standard profile, width: 35 mm, height: 15 mm, similar to EN 60715, material: Steel, galvanized, length: 2000 mm, color: silver

DIN rail, unperforated - NS 35/15 CU UNPERF 2000MM - 1201895



DIN rail, unperforated, Standard profile, width: 35 mm, height: 15 mm, similar to EN 60715, material: Copper, uncoated, length: 2000 mm, color: copper-colored

End cap - NS 35/15 CAP - 1206573



DIN rail end piece, for DIN rail NS 35/15

Relay Module - PLC-RSC-120UC/ 1/SEN - 2966249

Accessories

DIN rail, unperforated - NS 35/15-2,3 UNPERF 2000MM - 1201798



DIN rail, unperforated, Standard profile 2.3 mm, width: 35 mm, height: 15 mm, acc. to EN 60715, material: Steel, galvanized, passivated with a thick layer, length: 2000 mm, color: silver

Labeled terminal marker

Zack marker strip - ZB 6 CUS - 0824992



Zack marker strip, can be ordered: Strip, white, labeled according to customer specifications, mounting type: snap into tall marker groove, for terminal block width: 6.2 mm, lettering field size: 6.15 x 10.5 mm, Number of individual labels: 10

Zack marker strip - ZB 6,LGS:FORTL.ZAHLEN - 1051016



Zack marker strip, Strip, white, labeled, can be labeled with: CMS-P1-PLOTTER, printed horizontally: consecutive numbers 1 ... 10, 11 ... 20, etc. up to 491 ... 500, mounting type: snap into tall marker groove, for terminal block width: 6.2 mm, lettering field size: 6.15 x 10.5 mm, Number of individual labels: 10

Zack marker strip - ZB 6,QR:FORTL.ZAHLEN - 1051029



Zack marker strip, Strip, white, labeled, can be labeled with: CMS-P1-PLOTTER, Printed vertically: consecutive numbers 1 ... 10, 11 ... 20, etc. up to 491 ... 500, mounting type: snap into tall marker groove, for terminal block width: 6.2 mm, lettering field size: 6.15 x 10.5 mm, Number of individual labels: 10

Zack marker strip - ZB 6,LGS:GLEICHE ZAHLEN - 1051032



Zack marker strip, Strip, white, labeled, can be labeled with: CMS-P1-PLOTTER, printed horizontally: Identical numbers 1 or 2, etc. up to 100, mounting type: snap into tall marker groove, for terminal block width: 6.2 mm, lettering field size: 6.15 x 10.5 mm, Number of individual labels: 10

Relay Module - PLC-RSC-120UC/ 1/SEN - 2966249

Accessories

Marker for terminal blocks - ZB 6,LGS:L1-N,PE - 1051414



Marker for terminal blocks, Strip, white, labeled, can be labeled with: CMS-P1-PLOTTER, horizontal: L1, L2, L3, N, PE, L1, L2, L3, N, PE, mounting type: snap into tall marker groove, for terminal block width: 6.2 mm, lettering field size: 6.15 x 10.5 mm, Number of individual labels: 10

Marker for terminal blocks - ZB 6,LGS:U-N - 1051430



Marker for terminal blocks, Strip, white, labeled, can be labeled with: CMS-P1-PLOTTER, printed horizontally: U, V, W, N, GND, U, V, W, N, GND, mounting type: snap into tall marker groove, for terminal block width: 6.2 mm, lettering field size: 6.15 x 10.5 mm, Number of individual labels: 10

Marker for terminal blocks - UC-TM 6 CUS - 0824589



Marker for terminal blocks, can be ordered: by sheet, white, labeled according to customer specifications, mounting type: snap into tall marker groove, for terminal block width: 6.2 mm, lettering field size: 5.6 x 10.5 mm, Number of individual labels: 80

Marker for terminal blocks - UCT-TM 6 CUS - 0829602



Marker for terminal blocks, can be ordered: by sheet, white, labeled according to customer specifications, mounting type: snap into tall marker groove, for terminal block width: 6.2 mm, lettering field size: 5.6 x 10.5 mm, Number of individual labels: 60

Partition plate

Separating plate - PLC-ATP BK - 2966841



Separating plate, 2 mm thick, required at the start and end of a PLC terminal strip. Furthermore, it is used for: visual separation of groups, safe isolation of different voltages of neighboring PLC relays in acc. with DIN VDE 0106-101, isolation

Power module

Relay Module - PLC-RSC-120UC/ 1/SEN - 2966249

Accessories

Power terminal block - PLC-ESK GY - 2966508



Power terminal block, for the input of up to four potentials, for mounting on NS 35/7.5

Screwdriver tools

Screwdriver - SZF 1-0,6X3,5 - 1204517



Actuation tool, for ST terminal blocks, also suitable for use as a bladed screwdriver, size: 0.6 x 3.5 x 100 mm, 2-component grip, with non-slip grip

Terminal marking

Zack marker strip - ZB 6:UNBEDRUCKT - 1051003



Zack marker strip, Strip, white, unlabeled, can be labeled with: PLOTMARK, CMS-P1-PLOTTER, mounting type: snap into tall marker groove, for terminal block width: 6.2 mm, lettering field size: 6.15 x 10.5 mm, Number of individual labels: 10

Marker for terminal blocks - UC-TM 6 - 0818085



Marker for terminal blocks, Sheet, white, unlabeled, can be labeled with: BLUEMARK ID COLOR, BLUEMARK ID, BLUEMARK CLED, PLOTMARK, CMS-P1-PLOTTER, mounting type: snap into tall marker groove, for terminal block width: 6.2 mm, lettering field size: 5.6 x 10.5 mm, Number of individual labels: 80

Marker for terminal blocks - UCT-TM 6 - 0828736



Marker for terminal blocks, Sheet, white, unlabeled, can be labeled with: TOPMARK NEO, TOPMARK LASER, BLUEMARK ID COLOR, BLUEMARK ID, BLUEMARK CLED, THERMOMARK PRIME, THERMOMARK CARD 2.0, THERMOMARK CARD, mounting type: snap into tall marker groove, for terminal block width: 6.2 mm, lettering field size: 5.6 x 10.5 mm, Number of individual labels: 60

Phoenix Contact 2020 © - all rights reserved
<http://www.phoenixcontact.com>

PHOENIX CONTACT GmbH & Co. KG
Flachmarktstr. 8
32825 Blomberg
Germany
Tel. +49 5235 300
Fax +49 5235 3 41200
<http://www.phoenixcontact.com>

Mouser Electronics

Authorized Distributor

Click to View Pricing, Inventory, Delivery & Lifecycle Information:

[Phoenix Contact:](#)

[2966249](#)