

# Printed-circuit board connector - FKCS 2,5/19-ST-5,08 - 1975244

Please be informed that the data shown in this PDF Document is generated from our Online Catalog. Please find the complete data in the user's documentation. Our General Terms of Use for Downloads are valid (<http://phoenixcontact.com/download>)

PCB connector, nominal current: 12 A, rated voltage (III/2): 320 V, nominal cross section: 2.5 mm<sup>2</sup>, number of positions: 19, pitch: 5.08 mm, connection method: Push-in spring connection, color: green, contact surface: Tin



The figure shows a 10-position version of the product

## Your advantages

- Time saving push-in connection, tools not required
- Clamping space opened by means of fixed screwdriver enables convenient conductor connection
- Quick and convenient testing using integrated test option
- Can be combined with the MSTB 2,5 range



## Key Commercial Data

Packing unit	50 pc
GTIN	 4 017918 971571
GTIN	4017918971571

## Technical data

### Item properties

Brief article description	Printed-circuit board connector
Plug-in system	CLASSIC COMBICON
Type of contact	Female connector
Range of articles	FKCS 2,5/...-ST
Pitch	5.08 mm
Number of positions	19
Connection method	Push-in spring connection
Locking	without
Number of levels	1
Number of connections	19
Number of potentials	19

# Printed-circuit board connector - FKCS 2,5/19-ST-5,08 - 1975244

## Technical data

### Electrical parameters

Nominal current	12 A
Nom. voltage	320 V
Rated voltage	320 V
Rated voltage (III/2)	320 V
Rated voltage (II/2)	630 V
Rated surge voltage (III/3)	4 kV
Rated surge voltage (III/2)	4 kV
Rated surge voltage (II/2)	4 kV

### Connection capacity

Connection method	Push-in spring connection
pluggable	Yes
Conductor cross section solid	0.2 mm <sup>2</sup> ... 2.5 mm <sup>2</sup>
Conductor cross section flexible	0.2 mm <sup>2</sup> ... 2.5 mm <sup>2</sup>
Conductor cross section AWG / kcmil	24 ... 12
Conductor cross section flexible, with ferrule without plastic sleeve	0.25 mm <sup>2</sup> ... 2.5 mm <sup>2</sup>
Conductor cross section, flexible, with ferrule, with plastic sleeve	0.25 mm <sup>2</sup> ... 2.5 mm <sup>2</sup>
2 conductors with the same cross section, flexible, with TWIN ferrule with plastic sleeve	0.5 mm <sup>2</sup> ... 1.5 mm <sup>2</sup>
Cylindrical gauge a x b / diameter	2.8 mm x 2.0 mm / 2.0 mm
Stripping length	10 mm

### Material data - contact

Note	WEEE/RoHS-compliant, free of whiskers according to IEC 60068-2-82/ JEDEC JESD 201
Contact material	Cu alloy
Surface characteristics	hot-dip tin-plated
Metal surface terminal point (top layer)	Tin (4 - 8 µm Sn)
Metal surface contact area (top layer)	Tin (4 - 8 µm Sn)

### Material data - housing

Housing color	green (6021)
Insulating material	PA
Insulating material group	I
CTI according to IEC 60112	600
Flammability rating according to UL 94	V0
Glow wire flammability index GWFI according to EN 60695-2-12	850
Glow wire ignition temperature GWIT according to EN 60695-2-13	775
Temperature for the ball pressure test according to EN 60695-10-2	125 °C

### Dimensions for the product

Length [ l ]	25.23 mm
Width [ w ]	97.14 mm
Height [ h ]	15 mm

# Printed-circuit board connector - FKCS 2,5/19-ST-5,08 - 1975244

## Technical data

### Dimensions for the product

Pitch	5.08 mm
-------	---------

### Packaging information

Type of packaging	packed in cardboard
Pieces per package	50
Denomination packing units	Pcs.

### Ambient conditions

Ambient temperature (storage/transport)	-40 °C ... 70 °C
Ambient temperature (assembly)	-5 °C ... 100 °C
Ambient temperature (operation)	-40 °C ... 100 °C (dependent on the derating curve)

### Termination and connection method

Conductor connection test	The stripped-off ends of the largest conductor can be completely inserted in the opening of the terminal point without using excessive force.
Test result	Test passed
Test – repeated connection and release	IEC 60999-1:1999-11
	Test passed
Test for conductor damage and slackening	IEC 60999-1:1999-11
	Test passed

### Pull-out test

Pull-out test	IEC 60999-1:1999-11
	Test passed
Conductor cross section / conductor type / tensile force	0.2 mm <sup>2</sup> / solid / > 10 N
	0.2 mm <sup>2</sup> / flexible / > 10 N
	2.5 mm <sup>2</sup> / solid / > 50 N
	2.5 mm <sup>2</sup> / flexible / > 50 N

### Mechanical tests according to standard

Test specification	IEC 61984
Visual inspection	IEC 60512-1-1:2002-02
Dimension check	IEC 60512-1-2:2002-02
Resistance of inscriptions	IEC 60068-2-70:1995-12
Insertion and withdrawal force	IEC 60512-13-2:2006-02
No. of cycles	25
Insertion strength per pos. approx.	8 N
Withdraw strength per pos. approx.	6 N
Polarization and coding	IEC 60512-13-5:2006-02
Contact holder in insert	IEC 60512-15-1:2008-05
Test force per pos.	29 N

### Air clearances and creepage distances

Clearances and creepage distances	IEC 60664-1:2007-04
-----------------------------------	---------------------

# Printed-circuit board connector - FKCS 2,5/19-ST-5,08 - 1975244

## Technical data

### Air clearances and creepage distances

Specification	IEC 60664-1:2007-04
Minimum clearance - inhomogeneous field (III/3)	3 mm
Minimum clearance - inhomogeneous field (III/2)	3 mm
Minimum clearance - inhomogeneous field (II/2)	3 mm
Minimum creepage distance value (III/3)	4 mm
Minimum creepage distance value (III/2)	3 mm
Minimum creepage distance value (II/2)	3.2 mm

### Electrical tests - Function

Specification	IEC 60999-1:1999-11
---------------	---------------------

### Temperature cycles

Specification	IEC 60999-1:1999-11
Test current (minimum cross section)	4 A AC
Test current (maximum cross section)	12 A AC
Temperature cycles	192

### Current carrying capacity / derating curves

Caption	Type: FKCS 2,5/...-ST-5,08 with CCA 2,5/...-G-5,08 P26THR
Specification	IEC 61984:2008-10
Reduction factor	0.8
Note	Representation based on IEC 60512-5-2:2002-02
	For number of positions, see diagram

### Mechanical tests (A)

Test specification	IEC 61984
Insertion strength per pos. approx.	8 N
Withdraw strength per pos. approx.	6 N
Polarization when inserted requirement >20 N	Test passed
Contact holder in insert requirements >20 N	Test passed

### Durability tests (B)

Specification	IEC 60512-9-1:2010-03
Contact resistance R <sub>1</sub>	1.1 mΩ
Insertion/withdrawal cycles	25
Contact resistance R <sub>2</sub>	1.2 mΩ
Impulse withstand voltage at sea level	4.8 kV
Power-frequency withstand voltage	2.21 kV
Insulation resistance, neighboring positions	> 24 GΩ

### Thermal tests (C)

Specification	IEC 60512-5-1:2002-02
Number of positions	12
Conductor cross section	2.5 mm <sup>2</sup>

# Printed-circuit board connector - FKCS 2,5/19-ST-5,08 - 1975244

## Technical data

### Thermal tests (C)

Test current	12 A DC
Upper limiting temperature requirements <100 °C	Test passed

### Climatic tests (D)

Specification	ISO 6988:1985-02
Cold stress	-40 °C/2 h
Thermal stress	100 °C/168 h
Corrosive stress	0.2 dm <sup>3</sup> SO <sub>2</sub> on 300 dm <sup>3</sup> /40 °C/1 cycle
Impulse withstand voltage at sea level	4.8 kV
Power-frequency withstand voltage	2.21 kV

### Environmental and durability tests (E)

Specification	IEC 61984:2008-10
Result, degree of protection, IP code	Finger safety with IP20 test finger

### Environmental Product Compliance

China RoHS	Environmentally friendly use period: unlimited = EFUP-e
	No hazardous substances above threshold values

## Drawings

Diagram

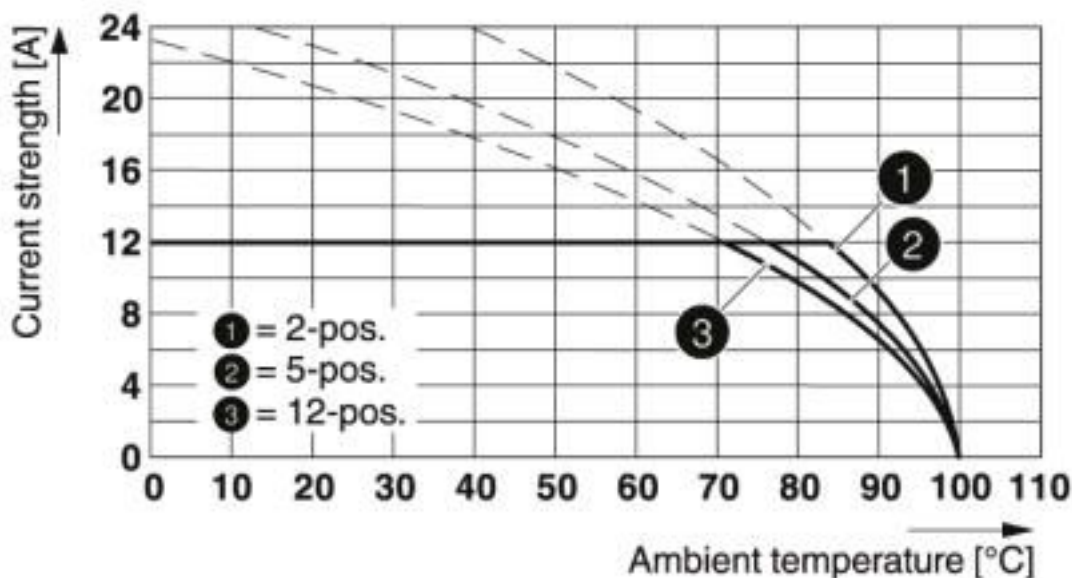

Type: FKCS 2,5/....-ST-5,08 with CCA 2,5/....-G-5,08 P26THR

# Printed-circuit board connector - FKCS 2,5/19-ST-5,08 - 1975244

Diagram

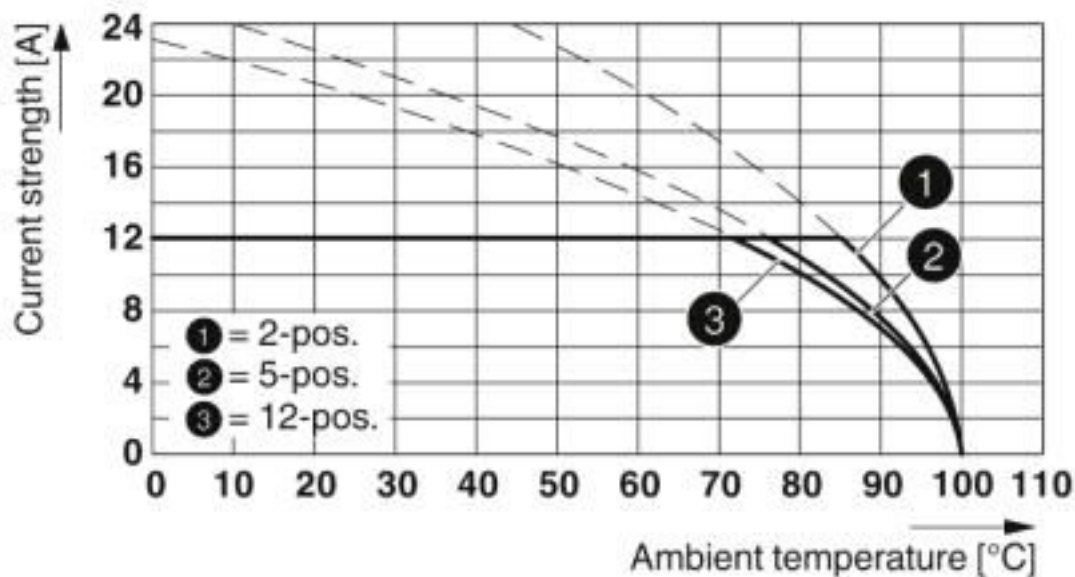

Type: FKCS 2,5/...-ST-5,08 with CCVA 2,5/...-G-5,08 P26THR

Diagram

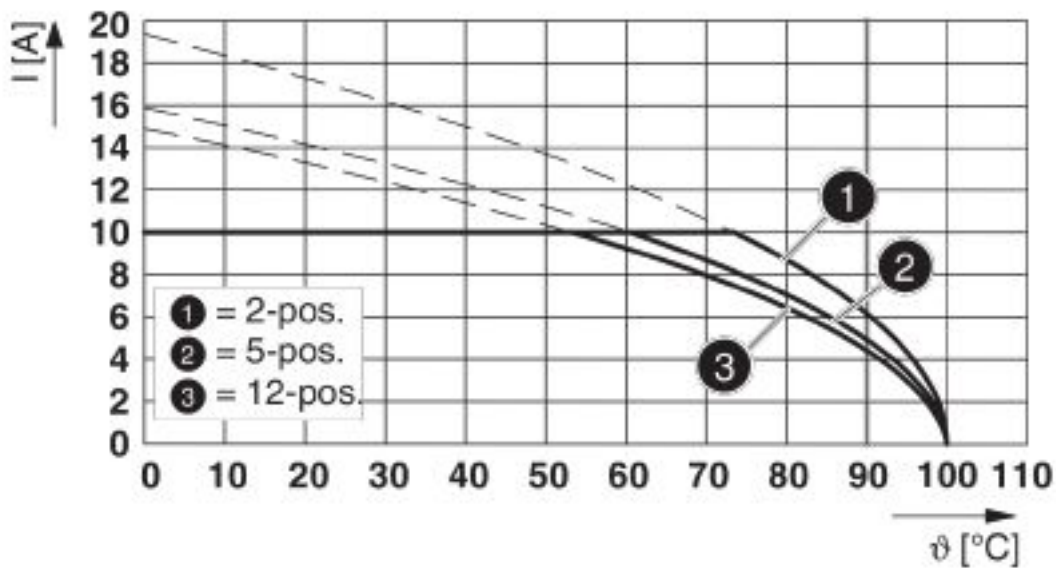

Type: FKCS 2,5/...-ST-5,08 with MDSTBV 2,5/...-G-5,08

# Printed-circuit board connector - FKCS 2,5/19-ST-5,08 - 1975244

Diagram

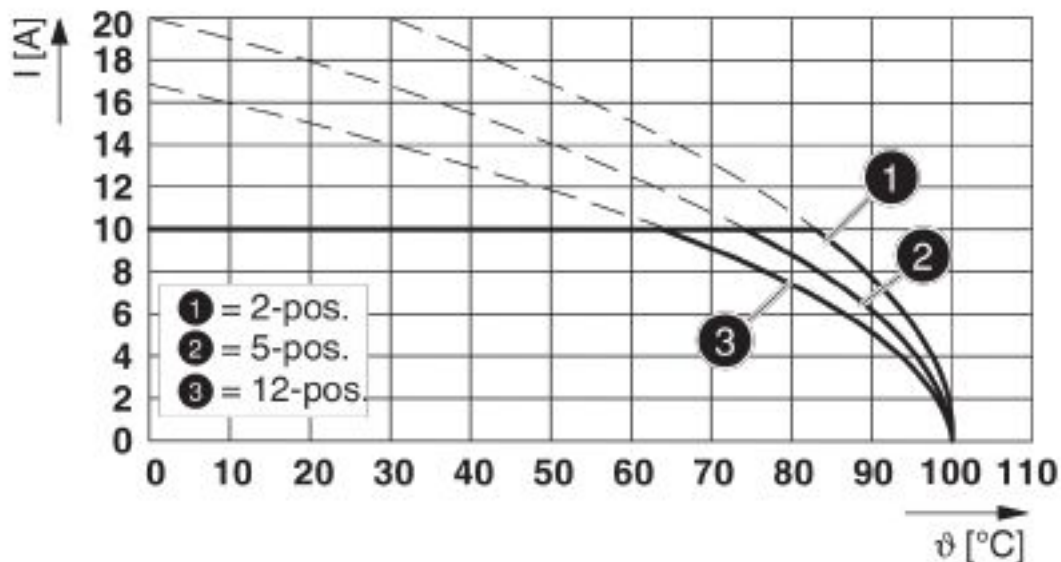

Type: FKCS 2,5/...-ST-5,08 with MDSTBA 2,5/...-G-5,08

Diagram

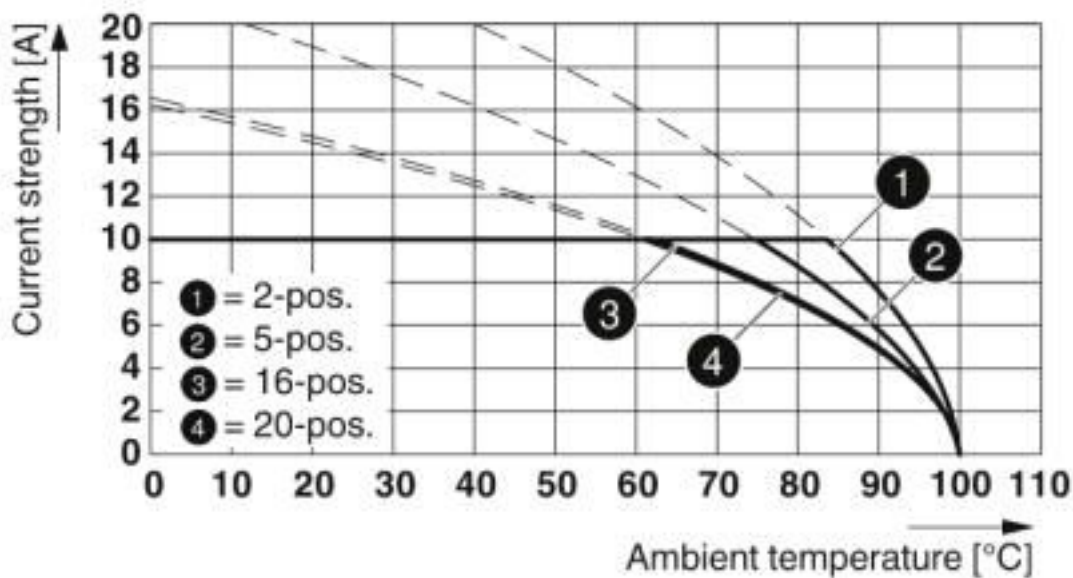

Type: FKCS 2,5/...-ST-5,08 with MDSTB 2,5/...-G1-5,08

# Printed-circuit board connector - FKCS 2,5/19-ST-5,08 - 1975244

Diagram

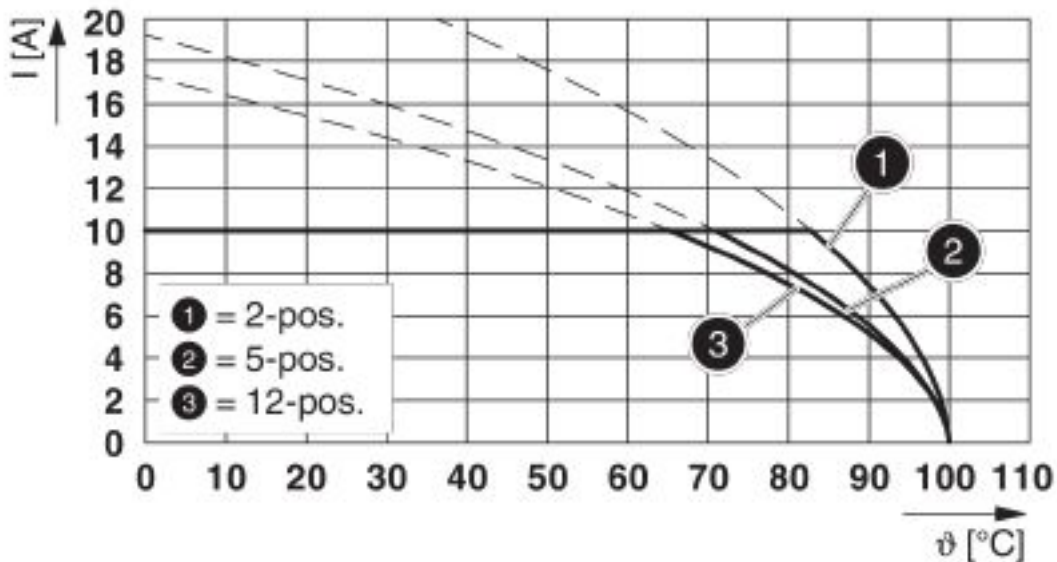

Type: FKCS 2,5/...-ST-5,08 with MDSTBW 2,5/...-G-5,08

Diagram

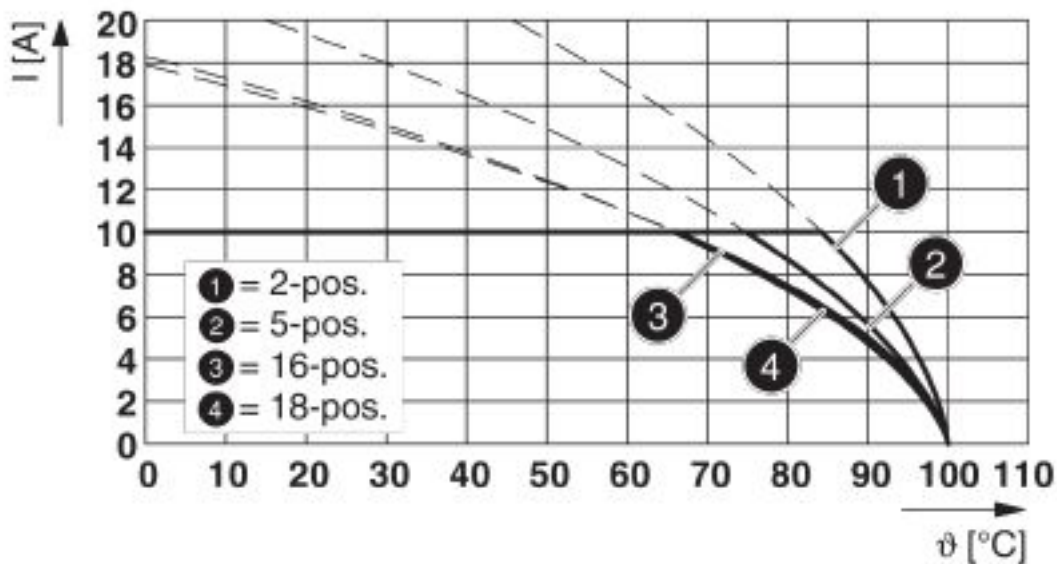

Type: FKCS 2,5/...-ST-5,08 with CCDN 2,5/...-G1-5,08 P...THR



# Printed-circuit board connector - FKCS 2,5/19-ST-5,08 - 1975244

Diagram

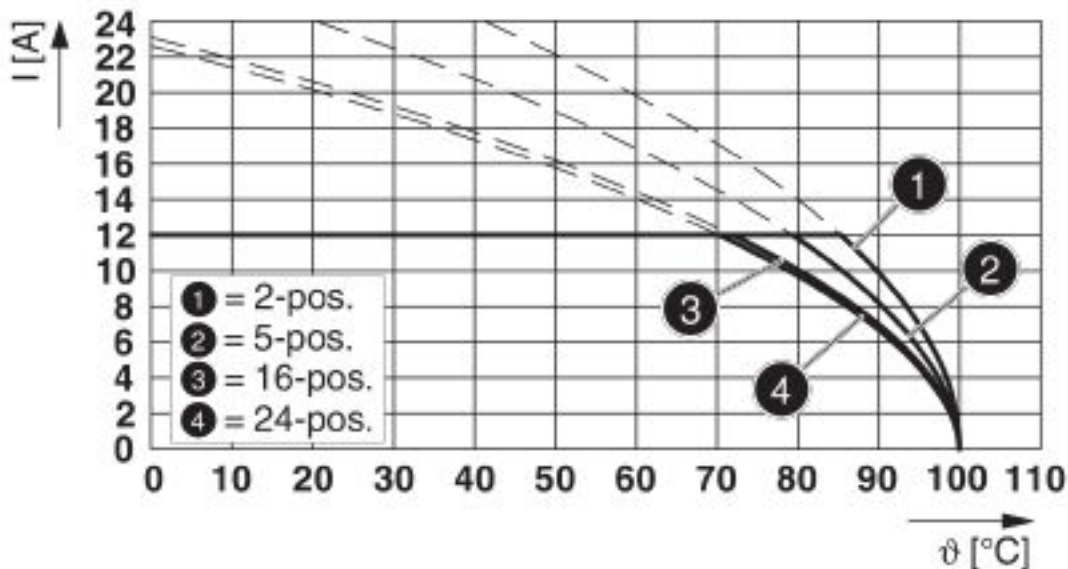

Type: FKCS 2,5/...-ST-5,08 with SMSTB 2,5/...-G-5,08

Diagram

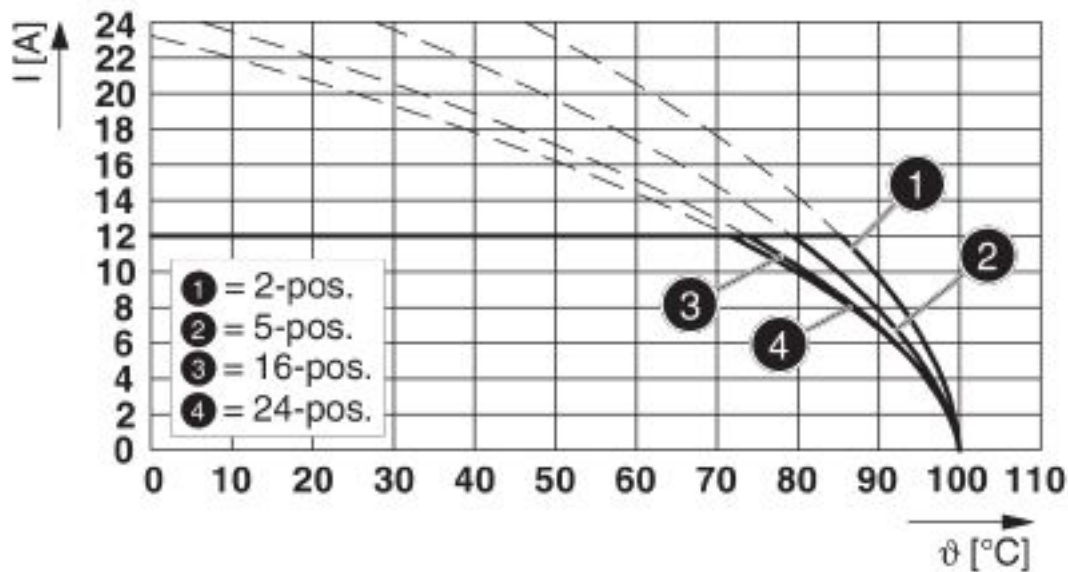

Type: FKCS 2,5/...-ST-5,08 with SMSTBA 2,5/...-G-5,08

# Printed-circuit board connector - FKCS 2,5/19-ST-5,08 - 1975244

Diagram

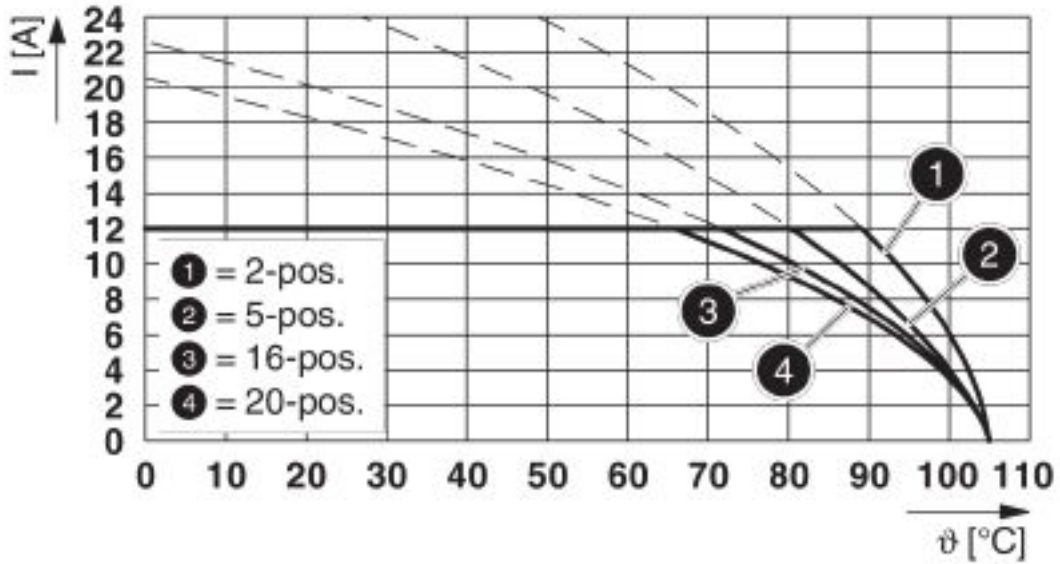

Type: FKCS 2,5/...-ST-5,08 with MSTBW 2,5/...-G-5,08

Diagram

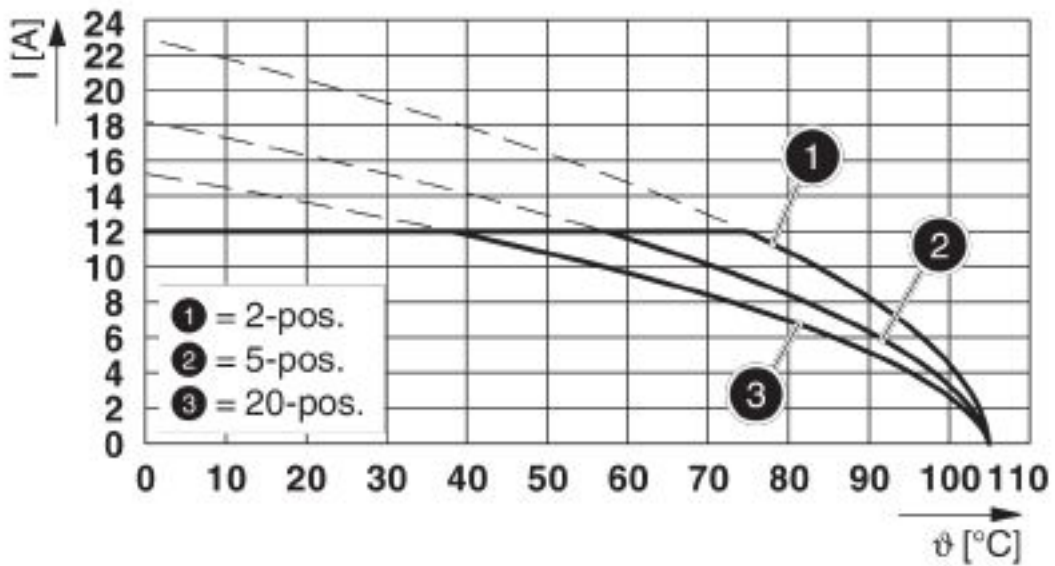

Type: FKCS 2,5/...-ST-5,08 with MSTBV 2,5/...-G-5,08

# Printed-circuit board connector - FKCS 2,5/19-ST-5,08 - 1975244

Diagram

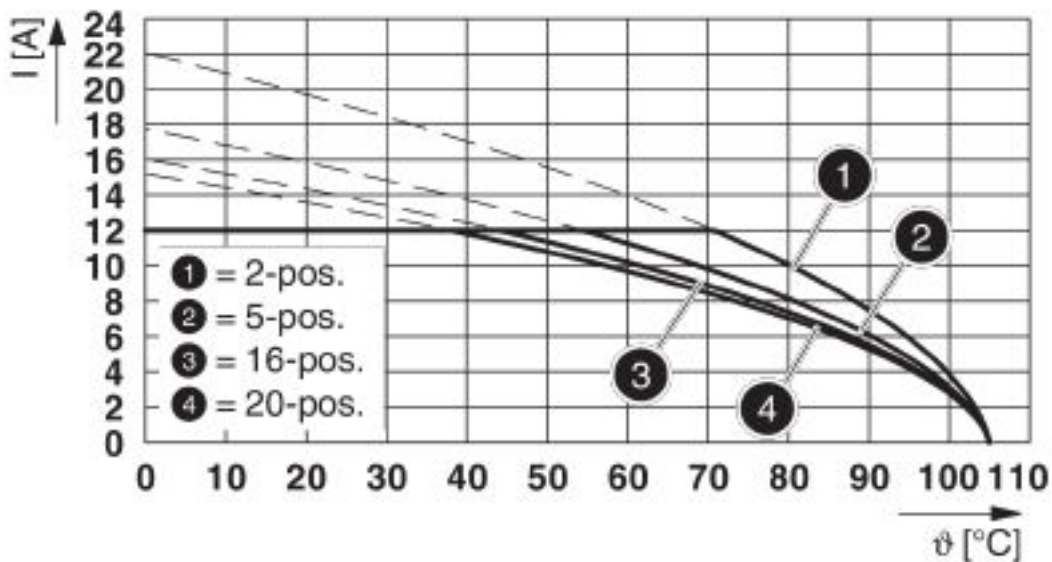

Type: FKCS 2,5/...-ST-5,08 with MSTBVA 2,5/...-G-5,08

Dimensional drawing

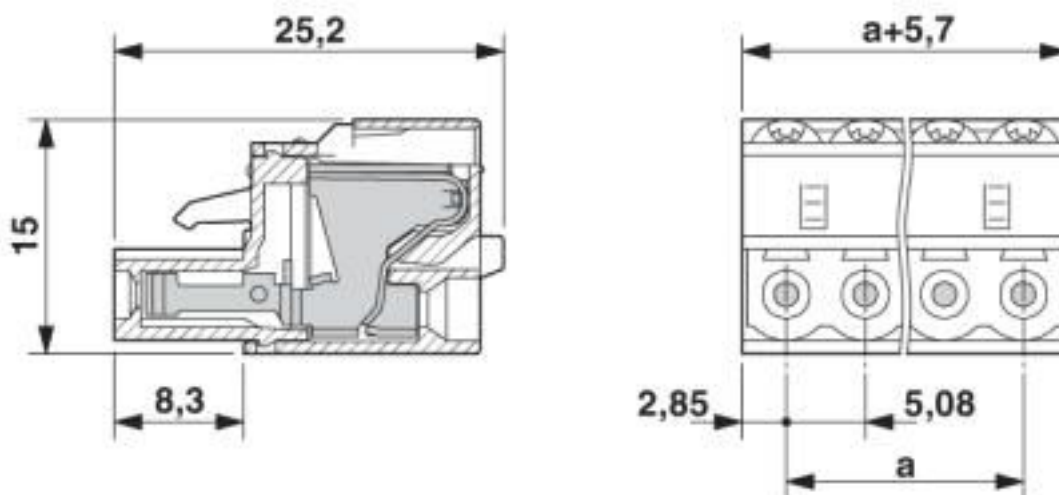

## Classifications

eCl@ss

eCl@ss 10.0.1	27440309
eCl@ss 4.0	27260700
eCl@ss 4.1	27260700
eCl@ss 5.0	27260700
eCl@ss 5.1	27260700
eCl@ss 6.0	27260700

# Printed-circuit board connector - FKCS 2,5/19-ST-5,08 - 1975244

## Classifications

### eCl@ss

eCl@ss 7.0	27440309
eCl@ss 8.0	27440309
eCl@ss 9.0	27440309

### ETIM

ETIM 3.0	EC001121
ETIM 4.0	EC002638
ETIM 5.0	EC002638
ETIM 6.0	EC002638
ETIM 7.0	EC002638

### UNSPSC

UNSPSC 6.01	30211810
UNSPSC 7.0901	39121409
UNSPSC 11	39121409
UNSPSC 12.01	39121409
UNSPSC 13.2	39121409
UNSPSC 18.0	39121409
UNSPSC 19.0	39121409
UNSPSC 20.0	39121409
UNSPSC 21.0	39121409

## Approvals

### Approvals

---

### Approvals

IECEE CB Scheme / EAC / cULus Recognized / VDE Zeichengenehmigung

---

### Ex Approvals

---

### Approval details

IECEE CB Scheme		<a href="http://www.iecee.org/">http://www.iecee.org/</a>	DE1-60988-B1B2
Nominal voltage UN	250 V		
Nominal current IN	12 A		
mm <sup>2</sup> /AWG/kcmil	0.2-2.5		

# Printed-circuit board connector - FKCS 2,5/19-ST-5,08 - 1975244

## Approvals

EAC		B.01687
-----	--	---------

cULus Recognized		<a href="http://database.ul.com/cgi-bin/XYV/template/LISEXT/1FRAME/index.htm">http://database.ul.com/cgi-bin/XYV/template/LISEXT/1FRAME/index.htm</a>	E60425-19931011
	B	D	
Nominal voltage UN	300 V	300 V	
Nominal current IN	10 A	10 A	
mm <sup>2</sup> /AWG/kcmil	26-12	26-12	

VDE Zeichengenehmigung		<a href="http://www2.vde.com/de/Institut/Online-Service/VDE-gepruefteProdukte/Seiten/Online-Suche.aspx">http://www2.vde.com/de/Institut/Online-Service/VDE-gepruefteProdukte/Seiten/Online-Suche.aspx</a>	40050694
Nominal voltage UN	250 V		
Nominal current IN	12 A		
mm <sup>2</sup> /AWG/kcmil	0.2-2.5		

## Accessories

### Accessories

#### Coding element

Coding profile - CP-MSTB - 1734634

Coding profile, is inserted into the slot on the plug or inverted header, red insulating material



#### Crimping tool

Crimping pliers - CRIMPFOX 6 - 1212034



Crimping pliers, for ferrules without insulating collar according to DIN 46228 Part 1 and ferrules with insulating collar according to DIN 46228 Part 4, 0.25 mm<sup>2</sup> ... 6.0 mm<sup>2</sup>, lateral entry, trapezoidal crimp

#### Insulating sleeve

## Printed-circuit board connector - FKCS 2,5/19-ST-5,08 - 1975244

### Accessories

Insulating sleeve - MPS-IH WH - 0201663

Insulating sleeve, color: white



Insulating sleeve - MPS-IH RD - 0201676

Insulating sleeve, color: red



Insulating sleeve - MPS-IH BU - 0201689

Insulating sleeve, color: blue



Insulating sleeve - MPS-IH GN - 0201702

Insulating sleeve, color: green



### Labeled terminal marker

Marker card - SK 5,08/3,8:FORTL.ZAHLEN - 0804293

Marker card, Card, white, labeled, horizontal: consecutive numbers 1 ... 10, 11 ... 20, etc. up to 91 ... (99)100, mounting type: adhesive, for terminal block width: 5.08 mm, lettering field size: 5.08 x 3.8 mm



### Screwdriver tools

## Printed-circuit board connector - FKCS 2,5/19-ST-5,08 - 1975244

### Accessories

Screwdriver - SZS 0,6X3,5 - 1205053



Actuation tool, for ST terminal blocks, insulated, also suitable for use as a bladed screwdriver, size: 0.6 x 3.5 x 100 mm, 2-component grip, with non-slip grip

---

### Strain relief

Strain relief - STZ 4-FKC-5,08 - 1876877



Strain relief for snapping into the latching chambers of the plugs, 4-pos.

---

Strain relief - STZ 8-FKC-5,08 - 1876880



Strain relief for snapping into the latching chambers of the plug components, 8-pos.

---

### Terminal marking

Marker card - SK 5,08/3,8:UNBEDRUCKT - 0805412



Marker card, Card, white, unlabeled, can be labeled with: Marker pen, mounting type: adhesive, for terminal block width: 5.08 mm, lettering field size: 5.08 x 3.8 mm

---

### Test plug terminal block

Test plugs - MPS-MT - 0201744



Test plugs, with solder connection up to 1 mm<sup>2</sup> conductor cross section, color: gray

## Printed-circuit board connector - FKCS 2,5/19-ST-5,08 - 1975244

### Accessories

Reducing plug - RPS - 0201647



Reducing plug, color: gray

---

### Additional products

Feed-through header - MSTBW 2,5/19-G-5,08 - 1735714



PCB headers, nominal current: 12 A, rated voltage (III/2): 320 V, nominal cross section: 2.5 mm<sup>2</sup>, number of positions: 19, pitch: 5.08 mm, color: green, contact surface: Tin, mounting: Wave soldering, pin layout: Linear pinning, solder pin [P]: 3.5 mm

---

Printed-circuit board connector - MSTBVA 2,5/19-G-5,08 - 1755901



PCB headers, nominal current: 12 A, rated voltage (III/2): 320 V, nominal cross section: 2.5 mm<sup>2</sup>, number of positions: 19, pitch: 5.08 mm, color: green, contact surface: Tin, mounting: Wave soldering, pin layout: Linear pinning, solder pin [P]: 3.9 mm

---

Printed-circuit board connector - MSTBA 2,5/19-G-5,08 - 1757417



PCB headers, nominal current: 12 A, rated voltage (III/2): 320 V, nominal cross section: 2.5 mm<sup>2</sup>, number of positions: 19, pitch: 5.08 mm, color: green, contact surface: Tin, mounting: Wave soldering, pin layout: Linear pinning, solder pin [P]: 3.5 mm

---

Feed-through header - MSTBV 2,5/19-G-5,08 - 1758186



PCB headers, nominal current: 12 A, rated voltage (III/2): 320 V, nominal cross section: 2.5 mm<sup>2</sup>, number of positions: 19, pitch: 5.08 mm, color: green, contact surface: Tin, mounting: Wave soldering, pin layout: Linear pinning, solder pin [P]: 3.9 mm



## Printed-circuit board connector - FKCS 2,5/19-ST-5,08 - 1975244

### Accessories

#### Feed-through header - MSTB 2,5/19-G-5,08 - 1759185

PCB headers, nominal current: 12 A, rated voltage (III/2): 320 V, nominal cross section: 2.5 mm<sup>2</sup>, number of positions: 19, pitch: 5.08 mm, color: green, contact surface: Tin, mounting: Wave soldering, pin layout: Linear pinning, solder pin [P]: 3.5 mm



#### Feed-through header - MDSTB 2,5/19-G1-5,08 - 1762538

PCB headers, nominal current: 10 A, rated voltage (III/2): 320 V, nominal cross section: 2.5 mm<sup>2</sup>, number of positions: 19, pitch: 5.08 mm, color: green, contact surface: Tin, mounting: Wave soldering, pin layout: Linear pinning, solder pin [P]: 3.5 mm. In combination with MVSTB or FKCV plug components, both an MVSTBW (or FKCVW) and an MVSTBR plug (or FKCVR) must be used. Combination with TMSTBP plug components is not possible!



#### Feed-through header - MDSTBV 2,5/19-G1-5,08 - 1762677

PCB headers, nominal current: 10 A, rated voltage (III/2): 320 V, nominal cross section: 2.5 mm<sup>2</sup>, number of positions: 19, pitch: 5.08 mm, color: green, contact surface: Tin, mounting: Wave soldering, pin layout: Linear pinning, solder pin [P]: 3.9 mm. In combination with MVSTB or FKCV plug components, both an MVSTBW (or FKCVW) and an MVSTBR plug (or FKCVR) must be used. Combination with TMSTBP plug components is not possible!



#### Feed-through header - SMSTBA 2,5/19-G-5,08 - 1767546

PCB headers, nominal current: 12 A, rated voltage (III/2): 320 V, nominal cross section: 2.5 mm<sup>2</sup>, number of positions: 19, pitch: 5.08 mm, color: green, contact surface: Tin, mounting: Wave soldering, pin layout: Linear pinning, solder pin [P]: 3.5 mm



#### Feed-through header - MSTBA 2,5/19-G-5,08-LA - 1768118

PCB headers, number of positions: 19, pitch: 5.08 mm, color: green, contact surface: Tin, pin layout: Linear pinning, solder pin [P]: 3.5 mm



## Printed-circuit board connector - FKCS 2,5/19-ST-5,08 - 1975244

### Accessories

Printed-circuit board connector - SMSTB 2,5/19-G-5,08 - 1769638

PCB headers, nominal current: 12 A, rated voltage (III/2): 320 V, nominal cross section: 2.5 mm<sup>2</sup>, number of positions: 19, pitch: 5.08 mm, color: green, contact surface: Tin, mounting: Wave soldering, pin layout: Linear pinning, solder pin [P]: 3.5 mm



Feed-through header - MSTBV 2,5/19-GEH-5,08 - 1808638

PCB headers, nominal current: 12 A, rated voltage (III/2): 320 V, nominal cross section: 2.5 mm<sup>2</sup>, number of positions: 19, pitch: 5.08 mm, color: green, contact surface: Tin, mounting: Wave soldering, pin layout: Linear pinning, solder pin [P]: 3.9 mm



Phoenix Contact 2020 © - all rights reserved  
<http://www.phoenixcontact.com>

PHOENIX CONTACT GmbH & Co. KG  
Flachsmarktstr. 8  
32825 Blomberg  
Germany  
Tel. +49 5235 300  
Fax +49 5235 3 41200  
<http://www.phoenixcontact.com>

# Mouser Electronics

Authorized Distributor

Click to View Pricing, Inventory, Delivery & Lifecycle Information:

[Phoenix Contact:](#)

[1975244](#)