

## Feed-through header - MCV 0,5/ 8-G-2,5 THT - 1963599

Please be informed that the data shown in this PDF Document is generated from our Online Catalog. Please find the complete data in the user's documentation. Our General Terms of Use for Downloads are valid (<http://phoenixcontact.com/download>)



PCB headers, nominal current: 4 A, rated voltage (III/2): 160 V, nominal cross section: 0.5 mm<sup>2</sup>, number of positions: 8, pitch: 2.5 mm, color: black, contact surface: Tin, mounting: THR soldering, pin layout: Linear pinning, solder pin [P]: 3.5 mm, User information and design recommendations for through hole reflow technology can be found under: Downloads

The figure shows a 10-position version of the product

### Your advantages

- Designed for integration into the SMT soldering process
- Vertical connection enables multi-row arrangement on the PCB



### Key Commercial Data

Packing unit	50 pc
GTIN	 4 017918 912406
GTIN	4017918912406

### Technical data

#### Item properties

Brief article description	Feed-through header
Plug-in system	MICRO COMBICON - FK-MC 0,5
Type of contact	Male connector
Range of articles	MCV 0,5/..-G-THT
Pitch	2.5 mm
Number of positions	8
Mounting type	THR soldering
Pin layout	Linear pinning
Locking	without
Number of levels	1
Number of connections	8
Number of potentials	8

# Feed-through header - MCV 0,5/ 8-G-2,5 THT - 1963599

## Technical data

### Electrical parameters

Nominal current	4 A
Nom. voltage	160 V
Rated voltage	32 V
Rated voltage (III/2)	160 V
Rated voltage (II/2)	160 V
Rated surge voltage (III/3)	1.5 kV
Rated surge voltage (III/2)	2.5 kV
Rated surge voltage (II/2)	2.5 kV

### Material data - contact

Note	WEEE/RoHS-compliant, free of whiskers according to IEC 60068-2-82/ JEDEC JESD 201
Contact material	Cu alloy
Surface characteristics	Tin-plated
Metal surface contact area (top layer)	Tin (3 - 5 µm Sn)
Metal surface contact area (middle layer)	Nickel (1 - 3 µm Ni),
Metal surface soldering area (top layer)	Tin (3 - 5 µm Sn)
Metal surface soldering area (middle layer)	Nickel (1 - 3 µm Ni)

### Material data - housing

Housing color	black (9005)
Insulating material	PA
Insulating material group	IIIa
CTI according to IEC 60112	250
Flammability rating according to UL 94	V0
Glow wire flammability index GWFI according to EN 60695-2-12	850
Glow wire ignition temperature GWIT according to EN 60695-2-13	775
Temperature for the ball pressure test according to EN 60695-10-2	125 °C

### Dimensions for the product

Length [ l ]	8.1 mm
Width [ w ]	21.9 mm
Height [ h ]	10.1 mm
Pitch	2.5 mm
Height (without solder pin)	10.1 mm
Solder pin [ P ]	3.5 mm
Pin spacing	2.50 mm
Pin dimensions	0.8 x 0.8 mm

### Dimensions for PCB design

Hole diameter	1.4 mm
Pin spacing	2.50 mm

### Packaging information

# Feed-through header - MCV 0,5/ 8-G-2,5 THT - 1963599

## Technical data

### Packaging information

Type of packaging	packed in cardboard
Pieces per package	50
Denomination packing units	Pcs.
Outer packaging type	Dry bag

### Processing notes

Process	Reflow/wave soldering
Specification	Following IPC/JEDEC J-STD-020D.1:2008-03
	Following IEC 61760-1:2006-04
	Following IEC 60068-2-58:2005-02
Moisture Sensitive Level	MSL 3
Classification temperature T <sub>c</sub>	245 °C
Solder cycles in the reflow	3

### Ambient conditions

Ambient temperature (storage/transport)	-40 °C ... 70 °C
Ambient temperature (assembly)	-5 °C ... 100 °C
Ambient temperature (operation)	-40 °C ... 100 °C (dependent on the derating curve)

### Air clearances and creepage distances

Clearances and creepage distances	IEC 60664-1:2007-04
Specification	IEC 60664-1:2007-04
Minimum clearance - inhomogeneous field (III/3)	0.8 mm
Minimum clearance - inhomogeneous field (III/2)	1.5 mm
Minimum clearance - inhomogeneous field (II/2)	0.5 mm
Minimum creepage distance value (III/3)	1.3 mm
Minimum creepage distance value (III/2)	1.6 mm
Minimum creepage distance value (II/2)	1.6 mm

### Mechanical tests (A)

Test specification	IEC 61984
Insertion strength per pos. approx.	8 N
Withdraw strength per pos. approx.	6 N
Polarization when inserted requirement >20 N	Test passed
Contact holder in insert requirements >20 N	Test passed

### Durability tests (B)

Specification	IEC 60512-9-1:2010-03
Contact resistance R <sub>1</sub>	2 mΩ
Insertion/withdrawal cycles	25
Contact resistance R <sub>2</sub>	2.2 mΩ
Impulse withstand voltage at sea level	2.95 kV
Power-frequency withstand voltage	1.39 kV

# Feed-through header - MCV 0,5/ 8-G-2,5 THT - 1963599

## Technical data

### Durability tests (B)

Insulation resistance, neighboring positions	> 10 TΩ
--	---------

### Thermal tests (C)

Specification	IEC 60512-5-1:2002-02
Number of positions	12
Conductor cross section	0.5 mm <sup>2</sup>
Test current	4 A
Upper limiting temperature requirements <100 °C	Test passed

### Climatic tests (D)

Specification	ISO 6988:1985-02
Cold stress	-40 °C/2 h
Thermal stress	100 °C/168 h
Corrosive stress	0.2 dm <sup>3</sup> SO <sub>2</sub> on 300 dm <sup>3</sup> /40 °C/1 cycle
Impulse withstand voltage at sea level	2.95 kV
Power-frequency withstand voltage	1.39 kV

### Environmental and durability tests (E)

Specification	IEC 61984:2008-10
Result, degree of protection, IP code	Finger safety with IP20 test finger

### Vibration test

Specification	IEC 60068-2-6:2007-12
Result	Test passed
Frequency	10 - 150 - 10 Hz
Sweep speed	1 octave/min
Amplitude	0.35 mm (10 - 60.1 Hz)
Acceleration	5 g (60.1 - 150 Hz)
Test duration per axis	2.5 h

### Standards and Regulations

Connection in acc. with standard	EN-VDE
	CUL
Flammability rating according to UL 94	V0

### Environmental Product Compliance

China RoHS	Environmentally friendly use period: unlimited = EFUP-e
	No hazardous substances above threshold values

## Drawings

# Feed-through header - MCV 0,5/ 8-G-2,5 THT - 1963599

Dimensional drawing

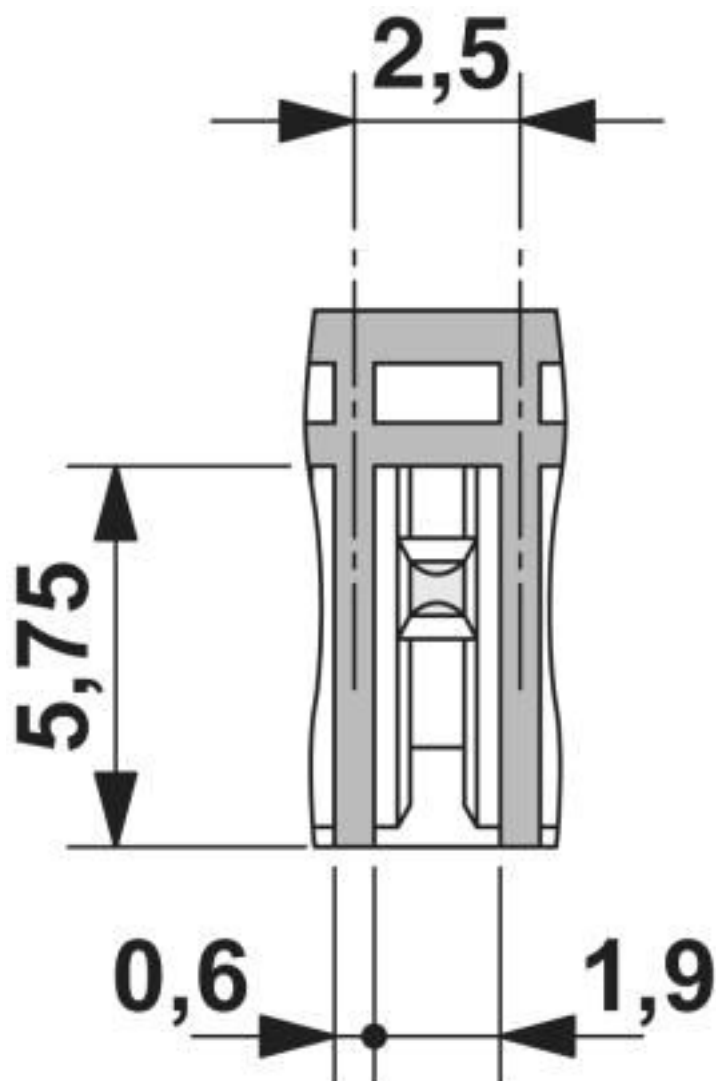

# Feed-through header - MCV 0,5/ 8-G-2,5 THT - 1963599

Drilling diagram

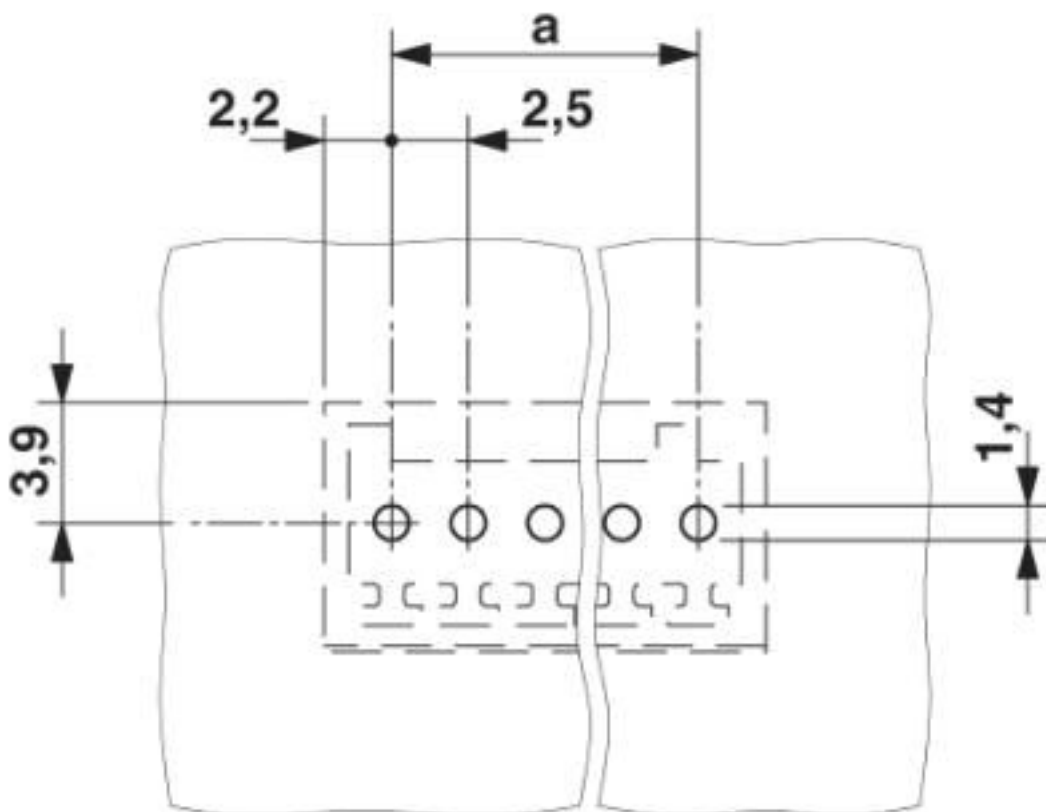

Diagram

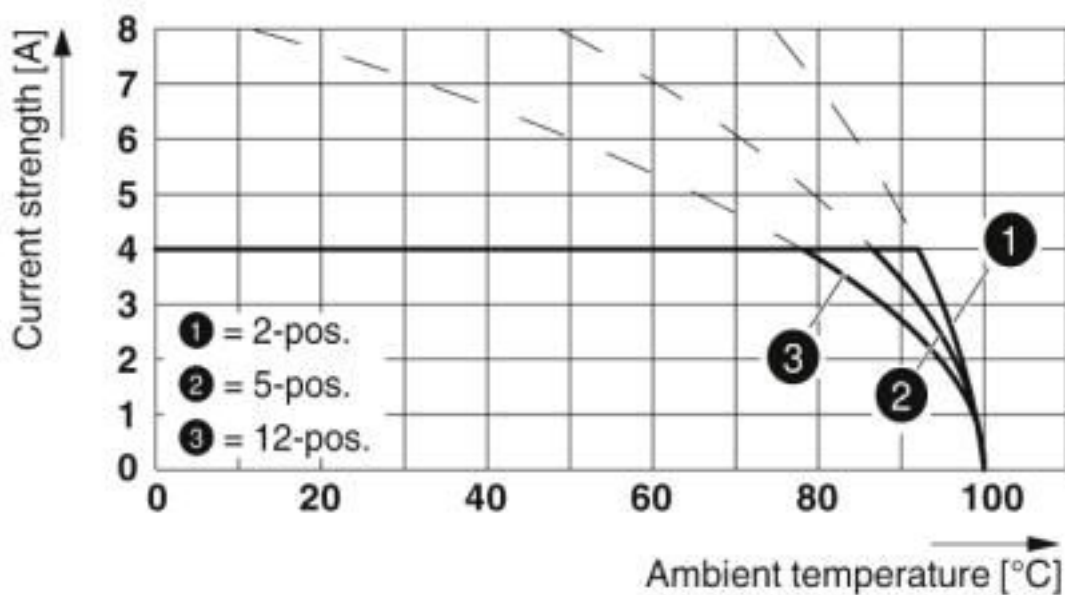

Type: FK-MC 0,5/...-ST-2,5 with MCV 0,5/...-G-2,5 THT

# Feed-through header - MCV 0,5/ 8-G-2,5 THT - 1963599

Dimensional drawing

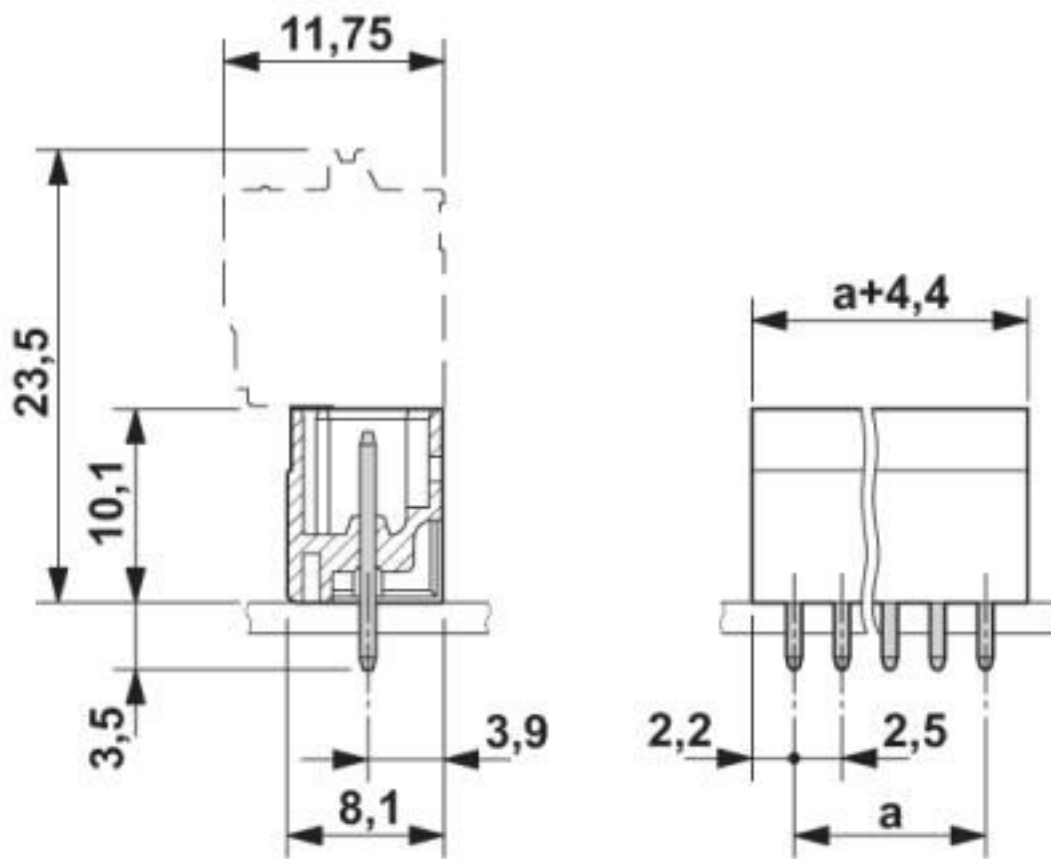

## Classifications

eCl@ss

eCl@ss 10.0.1	27440402
eCl@ss 4.0	27260700
eCl@ss 4.1	27260700
eCl@ss 5.0	27260700
eCl@ss 5.1	27260700
eCl@ss 6.0	27260700
eCl@ss 7.0	27440402
eCl@ss 8.0	27440402
eCl@ss 9.0	27440402

ETIM

ETIM 3.0	EC001121
ETIM 4.0	EC002637
ETIM 5.0	EC002637
ETIM 6.0	EC002637
ETIM 7.0	EC002637

# Feed-through header - MCV 0,5/ 8-G-2,5 THT - 1963599

## Classifications

### UNSPSC

UNSPSC 6.01	30211810
UNSPSC 7.0901	39121409
UNSPSC 11	39121409
UNSPSC 12.01	39121409
UNSPSC 13.2	39121409
UNSPSC 18.0	39121409
UNSPSC 19.0	39121409
UNSPSC 20.0	39121409
UNSPSC 21.0	39121409

## Approvals

### Approvals

#### Approvals

CCA / IECCEB Scheme / VDE Gutachten mit Fertigungsüberwachung / EAC / cULus Recognized

#### Ex Approvals

### Approval details

CCA	CCA/ DE1 34250
Nominal voltage UN	32 V
Nominal current IN	4 A

IECEE CB Scheme		<a href="http://www.iecee.org/">http://www.iecee.org/</a>	DE1-56068-B1B2
Nominal voltage UN	32 V		
Nominal current IN	4 A		

VDE Gutachten mit Fertigungsüberwachung		<a href="http://www2.vde.com/de/Institut/Online-Service/VDE-gepruefteProdukte/Seiten/Online-Suche.aspx">http://www2.vde.com/de/Institut/Online-Service/VDE-gepruefteProdukte/Seiten/Online-Suche.aspx</a>	40013394
Nominal voltage UN	32 V		
Nominal current IN	4 A		



# Feed-through header - MCV 0,5/ 8-G-2,5 THT - 1963599

## Approvals

EAC		B.01687
-----	--	---------

cULus Recognized		<a href="http://database.ul.com/cgi-bin/XYV/template/LISEXT/1FRAME/index.htm">http://database.ul.com/cgi-bin/XYV/template/LISEXT/1FRAME/index.htm</a>	E60425-19930913
		B	
Nominal voltage UN	125 V		
Nominal current IN	4 A		

## Accessories

### Accessories

#### Coding element

Coding profile - CP-MC 0,5 - 1881435



Coding profile, is inserted into the groove in the header, red insulating material

### Labeled terminal marker

Marker card - SK 2,54/2,8:FORTL.ZAHLEN - 0804853



Marker card, Card, white, labeled, horizontal: consecutive numbers 1 ... 10, 11 ... 20, etc. up to 91 ... 99, mounting type: adhesive, for terminal block width: 2.54 mm, lettering field size: 2.54 x 2.8 mm

### Additional products

Printed-circuit board connector - FK-MC 0,5/ 8-ST-2,5 - 1881383



PCB connector, nominal current: 4 A, rated voltage (III/2): 160 V, nominal cross section: 0.5 mm<sup>2</sup>, number of positions: 8, pitch: 2.5 mm, connection method: Push-in spring connection, color: green, contact surface: Tin

Phoenix Contact 2020 © - all rights reserved  
<http://www.phoenixcontact.com>

PHOENIX CONTACT GmbH & Co. KG  
Flachsmarktstr. 8  
32825 Blomberg  
Germany  
Tel. +49 5235 300  
Fax +49 5235 3 41200  
<http://www.phoenixcontact.com>

# Mouser Electronics

Authorized Distributor

Click to View Pricing, Inventory, Delivery & Lifecycle Information:

[Phoenix Contact:](#)

[1963599](#)