

Printed-circuit board connector - FKCVW 2,5/10-STF-5,08 - 1873883

Please be informed that the data shown in this PDF Document is generated from our Online Catalog. Please find the complete data in the user's documentation. Our General Terms of Use for Downloads are valid (<http://phoenixcontact.com/download>)

PCB connector, nominal current: 12 A, rated voltage (III/2): 320 V, nominal cross section: 2.5 mm², number of positions: 10, pitch: 5.08 mm, connection method: Push-in spring connection, color: green, contact surface: Tin



The figure shows a 10-position version of the product

Your advantages

- Time saving push-in connection, tools not required
- Intuitive use through colour coded actuation lever
- Quick and convenient testing using integrated test option
- Screwable flange for superior mechanical stability
- Can be combined with the MSTB 2,5 range



Key Commercial Data

Packing unit	50 pc
GTIN	
GTIN	4017918143275

Technical data

Item properties

Brief article description	Printed-circuit board connector
Plug-in system	CLASSIC COMBICON
Type of contact	Female connector
Range of articles	FKCVW 2,5/...-STF
Pitch	5.08 mm
Number of positions	10
Connection method	Push-in spring connection
Locking	Screw flange
Number of levels	1
Number of connections	10

Printed-circuit board connector - FKCVW 2,5/10-STF-5,08 - 1873883

Technical data

Item properties

Number of potentials	10
----------------------	----

Electrical parameters

Nominal current	12 A
Nom. voltage	320 V
Rated voltage	250 V
Rated voltage (III/2)	320 V
Rated voltage (II/2)	630 V
Rated surge voltage (III/3)	4 kV
Rated surge voltage (III/2)	4 kV
Rated surge voltage (II/2)	4 kV

Connection capacity

Connection method	Push-in spring connection
pluggable	Yes
Conductor cross section solid	0.2 mm ² ... 2.5 mm ²
Conductor cross section flexible	0.2 mm ² ... 2.5 mm ²
Conductor cross section AWG / kcmil	24 ... 12
Conductor cross section flexible, with ferrule without plastic sleeve	0.25 mm ² ... 2.5 mm ²
Conductor cross section, flexible, with ferrule, with plastic sleeve	0.25 mm ² ... 2.5 mm ²
2 conductors with the same cross section, flexible, with TWIN ferrule with plastic sleeve	0.5 mm ² ... 1.5 mm ²
Stripping length	10 mm

Flange specifications

Type of locking	Screw locking
Mounting flange	Screw flange

Material data - contact

Note	WEEE/RoHS-compliant, free of whiskers according to IEC 60068-2-82/ JEDEC JESD 201
Contact material	Cu alloy
Surface characteristics	hot-dip tin-plated
Metal surface terminal point (top layer)	Tin (4 - 8 µm Sn)
Metal surface contact area (top layer)	Tin (4 - 8 µm Sn)

Material data - housing

Housing color	green (6021)
Insulating material	PA
Insulating material group	I
CTI according to IEC 60112	600
Flammability rating according to UL 94	V0
Glow wire flammability index GWFI according to EN 60695-2-12	850
Glow wire ignition temperature GWIT according to EN 60695-2-13	775

Printed-circuit board connector - FKCVW 2,5/10-STF-5,08 - 1873883

Technical data

Material data - housing

Temperature for the ball pressure test according to EN 60695-10-2	125 °C
---	--------

Material data – actuating element

Insulating material	PBT
CTI according to IEC 60112	600
Flammability rating according to UL 94	V0

Dimensions for the product

Length [l]	26.6 mm
Width [w]	60.9 mm
Height [h]	19.2 mm
Pitch	5.08 mm
Height (without solder pin)	19.2 mm

Packaging information

Type of packaging	packed in cardboard
Pieces per package	50
Denomination packing units	Pcs.

Ambient conditions

Ambient temperature (storage/transport)	-40 °C ... 70 °C
Ambient temperature (assembly)	-5 °C ... 100 °C
Ambient temperature (operation)	-40 °C ... 100 °C (dependent on the derating curve)

Termination and connection method

Test – repeated connection and release	IEC 60999-1:1999-11
	Test passed
Test for conductor damage and slackening	IEC 60999-1:1999-11
	Test passed

Pull-out test

Pull-out test	IEC 60999-1:1999-11
	Test passed
Conductor cross section / conductor type / tensile force	0.2 mm ² / solid / > 10 N
	0.2 mm ² / flexible / > 10 N
	2.5 mm ² / solid / > 50 N
	2.5 mm ² / flexible / > 50 N

Mechanical tests according to standard

Test specification	IEC 61984
Visual inspection	IEC 60512-1-1:2002-02
Dimension check	IEC 60512-1-2:2002-02
Resistance of inscriptions	IEC 60068-2-70:1995-12
Insertion and withdrawal force	IEC 60512-13-2:2006-02
No. of cycles	25

Printed-circuit board connector - FKCVW 2,5/10-STF-5,08 - 1873883

Technical data

Mechanical tests according to standard

Insertion strength per pos. approx.	8 N
Withdraw strength per pos. approx.	6 N
Polarization and coding	IEC 60512-13-5:2006-02
Contact holder in insert	IEC 60512-15-1:2008-05
Test force per pos.	35 N

Air clearances and creepage distances

Clearances and creepage distances	IEC 60664-1:2007-04
Specification	IEC 60664-1:2007-04
Minimum clearance - inhomogeneous field (III/3)	3 mm
Minimum clearance - inhomogeneous field (III/2)	3 mm
Minimum clearance - inhomogeneous field (II/2)	3 mm
Minimum creepage distance value (III/3)	3.2 mm
Minimum creepage distance value (III/2)	1.6 mm
Minimum creepage distance value (II/2)	3.2 mm

Current carrying capacity / derating curves

Caption	Type: FKCV(W/R) 2,5/...-STF-5,08 with MDSTB 2,5/...-GF-5,08
Specification	IEC 61984:2008-10
Reduction factor	0.8
Note	Representation based on IEC 60512-5-2:2002-02
	For number of positions, see diagram

Mechanical tests (A)

Test specification	IEC 61984
Insertion strength per pos. approx.	8 N
Withdraw strength per pos. approx.	6 N
Polarization when inserted requirement >20 N	Test passed
Contact holder in insert requirements >20 N	Test passed

Durability tests (B)

Specification	IEC 60512-9-1:2010-03
Contact resistance R ₁	1.5 mΩ
Insertion/withdrawal cycles	25
Contact resistance R ₂	1.5 mΩ
Impulse withstand voltage at sea level	4.8 kV
Power-frequency withstand voltage	2.21 kV
Insulation resistance, neighboring positions	> 10 GΩ

Thermal tests (C)

Specification	IEC 60512-5-1:2002-02
Number of positions	12
Conductor cross section	2.5 mm ²

Printed-circuit board connector - FKCVW 2,5/10-STF-5,08 - 1873883

Technical data

Thermal tests (C)

Test current	10 A
Upper limiting temperature requirements <100 °C	Test passed

Climatic tests (D)

Specification	ISO 6988:1985-02
Cold stress	-40 °C/2 h
Thermal stress	100 °C/168 h
Corrosive stress	0.2 dm ³ SO ₂ on 300 dm ³ /40 °C/1 cycle
Impulse withstand voltage at sea level	4.8 kV
Power-frequency withstand voltage	2.21 kV

Environmental and durability tests (E)

Specification	IEC 61984:2008-10
Result, degree of protection, IP code	Finger safety with IP20 test finger

Environmental Product Compliance

China RoHS	Environmentally friendly use period: unlimited = EFUP-e
	No hazardous substances above threshold values

Drawings

Diagram

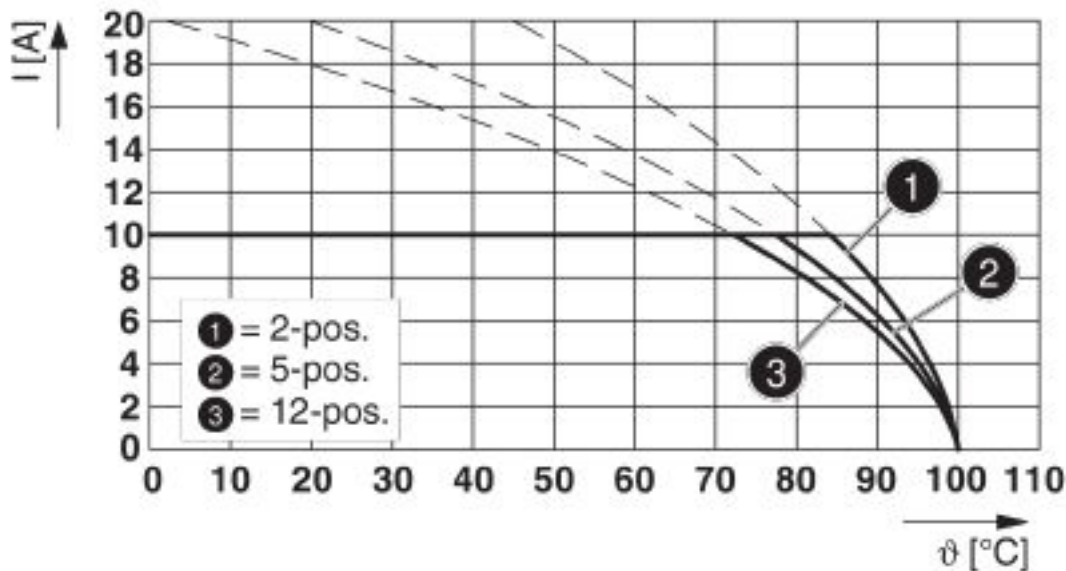

Type: FKCV(W/R) 2,5/...-STF-5,08 with MDSTB 2,5/...-GF-5,08

Printed-circuit board connector - FKCVW 2,5/10-STF-5,08 - 1873883

Diagram

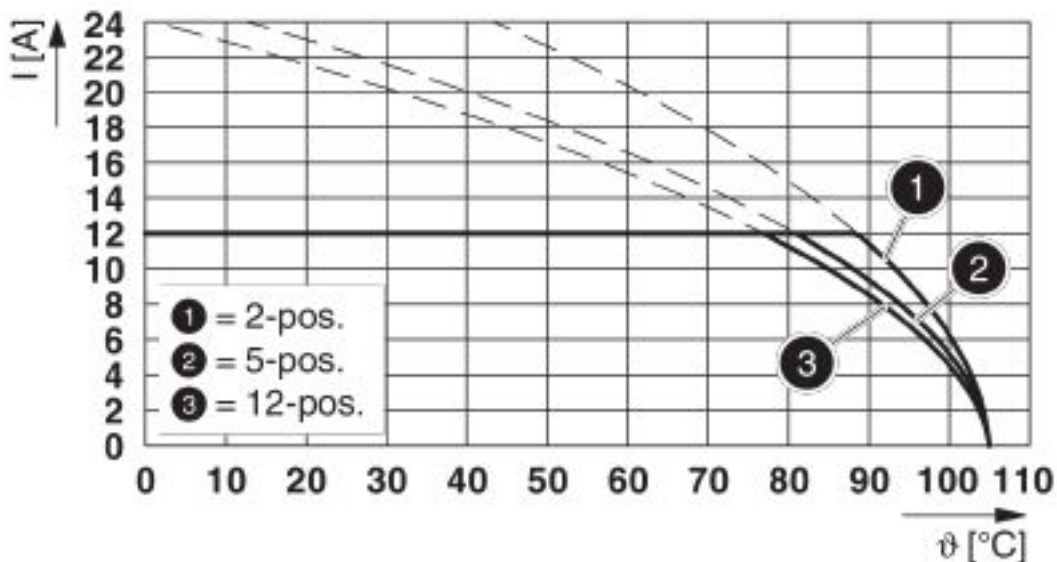

Type: FKCVW 2,5/...-STF-5,08 with CC 2,5/...-GF-5,08 P...THR

Diagram

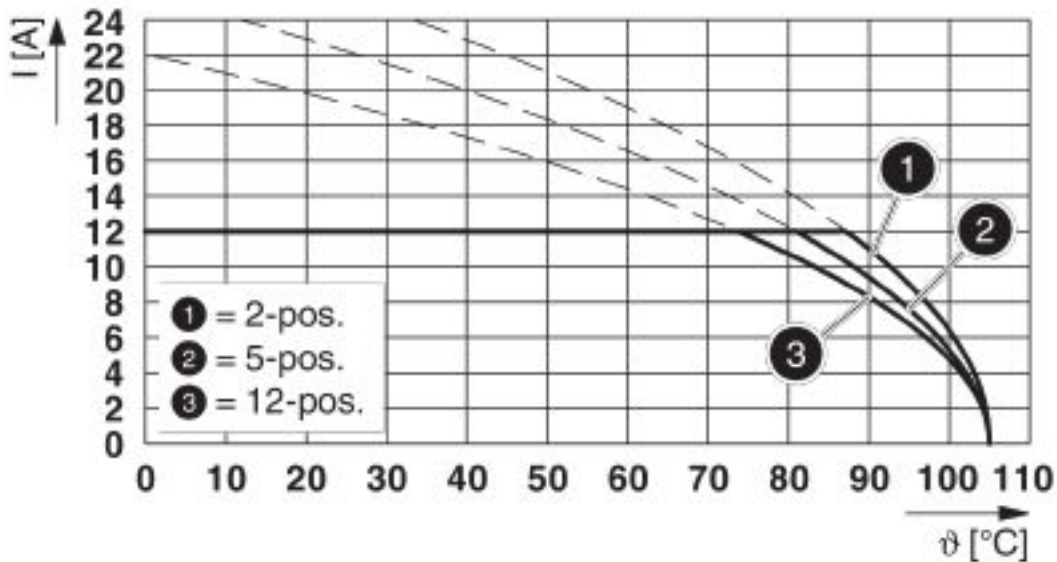

Type: FKCVW 2,5/...-STF-5,08 with CCV 2,5/...-GF-5,08 P...THR

Printed-circuit board connector - FKCVW 2,5/10-STF-5,08 - 1873883

Diagram

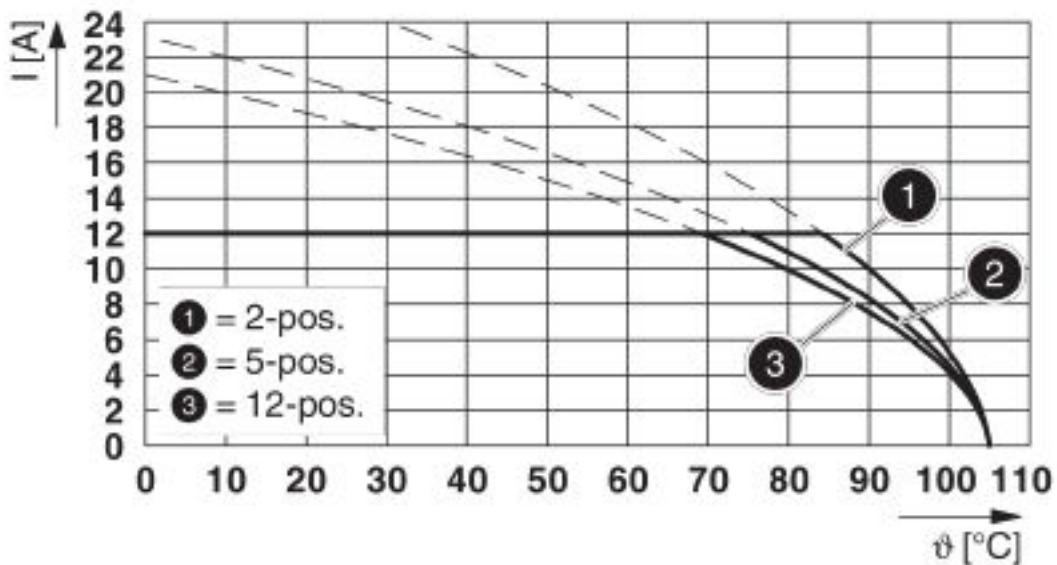

Type: FKCVW 2,5/...-STF-5,08 with CC 2,5/...-GF-5,08-LR P...THR

Diagram

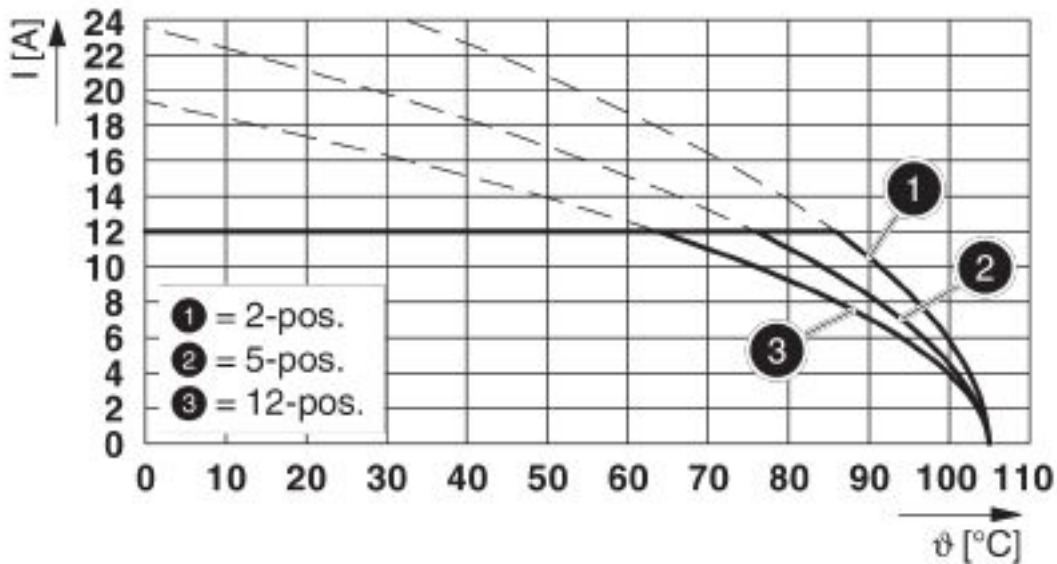

Type: FKCVW 2,5/...-STF-5,08 with CCV 2,5/...-GF-5,08-LR P...THR

Printed-circuit board connector - FKCVW 2,5/10-STF-5,08 - 1873883

Diagram

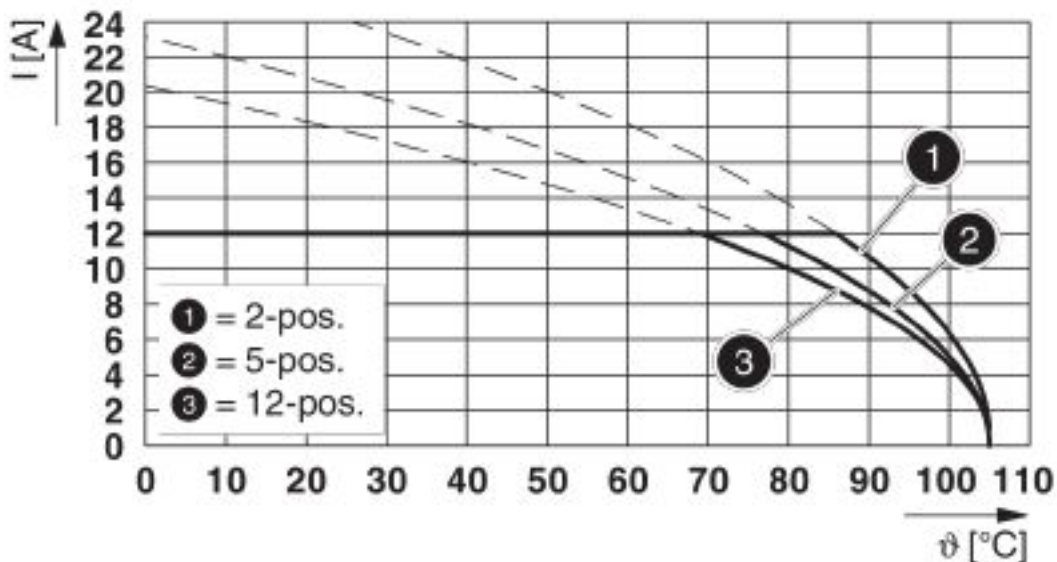

Type: FKCVW 2,5/...-STF-5,08 with MSTB 2,5/...-GF-5,08

Dimensional drawing

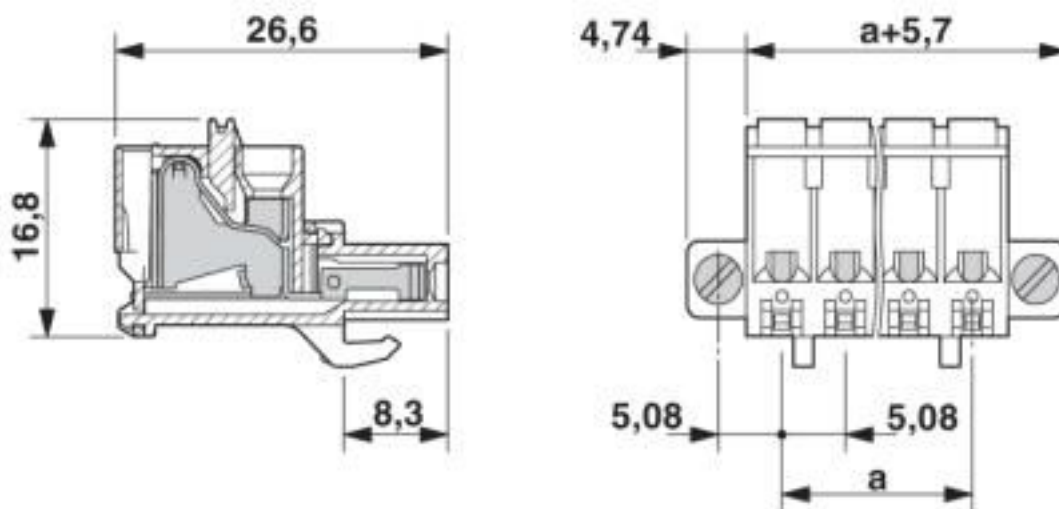

Classifications

eCl@ss

eCl@ss 10.0.1	27440309
eCl@ss 4.0	27260700
eCl@ss 4.1	27260700
eCl@ss 5.0	27260700
eCl@ss 5.1	27260700
eCl@ss 6.0	27260700

Printed-circuit board connector - FKCVW 2,5/10-STF-5,08 - 1873883

Classifications

eCl@ss

eCl@ss 7.0	27440309
eCl@ss 8.0	27440309
eCl@ss 9.0	27440309

ETIM

ETIM 3.0	EC001121
ETIM 4.0	EC002638
ETIM 5.0	EC002638
ETIM 6.0	EC002638
ETIM 7.0	EC002638

UNSPSC

UNSPSC 6.01	30211810
UNSPSC 7.0901	39121409
UNSPSC 11	39121409
UNSPSC 12.01	39121409
UNSPSC 13.2	39121409
UNSPSC 18.0	39121409
UNSPSC 19.0	39121409
UNSPSC 20.0	39121409
UNSPSC 21.0	39121409

Approvals

Approvals

Approvals

IECEE CB Scheme / EAC / cULus Recognized / VDE Zeichengenehmigung

Ex Approvals

Approval details

IECEE CB Scheme		http://www.iecee.org/	DE1-60988-B1B2
Nominal voltage UN	250 V		
Nominal current IN	12 A		
mm ² /AWG/kcmil	0.2-2.5		

Printed-circuit board connector - FKCVW 2,5/10-STF-5,08 - 1873883

Approvals

EAC		B.01687
-----	--	---------

cULus Recognized		http://database.ul.com/cgi-bin/XYV/template/LISEXT/1FRAME/index.htm	E60425-19931011
	B	D	
Nominal voltage UN	300 V	300 V	
Nominal current IN	10 A	10 A	
mm ² /AWG/kcmil	26-12	26-12	

VDE Zeichengenehmigung		http://www2.vde.com/de/Institut/Online-Service/VDE-gepruefteProdukte/Seiten/Online-Suche.aspx	40050694
Nominal voltage UN	250 V		
Nominal current IN	12 A		
mm ² /AWG/kcmil	0.2-2.5		

Accessories

Accessories

Coding element

Coding profile - CP-MSTB - 1734634

Coding profile, is inserted into the slot on the plug or inverted header, red insulating material



Labeled terminal marker

Marker card - SK 5,08/3,8:FORTL.ZAHLEN - 0804293

Marker card, Card, white, labeled, horizontal: consecutive numbers 1 ... 10, 11 ... 20, etc. up to 91 ... (99)100, mounting type: adhesive, for terminal block width: 5.08 mm, lettering field size: 5.08 x 3.8 mm



Screwdriver tools

Printed-circuit board connector - FKCVW 2,5/10-STF-5,08 - 1873883

Accessories

Screwdriver - SZS 0,6X3,5 - 1205053



Actuation tool, for ST terminal blocks, insulated, also suitable for use as a bladed screwdriver, size: 0.6 x 3.5 x 100 mm, 2-component grip, with non-slip grip

Strain relief

Strain relief - STZ 4-FKC-5,08 - 1876877



Strain relief for snapping into the latching chambers of the plugs, 4-pos.

Strain relief - STZ 8-FKC-5,08 - 1876880



Strain relief for snapping into the latching chambers of the plug components, 8-pos.

Test plug terminal block

Test plugs - MPS-MT - 0201744



Test plugs, with solder connection up to 1 mm² conductor cross section, color: gray

Reducing plug - RPS - 0201647



Reducing plug, color: gray

Additional products

Printed-circuit board connector - FKCVW 2,5/10-STF-5,08 - 1873883

Accessories

Feed-through header - MSTB 2,5/10-GF-5,08 - 1776582

PCB headers, nominal current: 12 A, rated voltage (III/2): 320 V, nominal cross section: 2.5 mm², number of positions: 10, pitch: 5.08 mm, color: green, contact surface: Tin, mounting: Wave soldering, pin layout: Linear pinning, solder pin [P]: 3.5 mm



Printed-circuit board connector - MSTBV 2,5/10-GF-5,08 - 1777154

PCB headers, nominal current: 12 A, rated voltage (III/2): 320 V, nominal cross section: 2.5 mm², number of positions: 10, pitch: 5.08 mm, color: green, contact surface: Tin, mounting: Wave soldering, pin layout: Linear pinning, solder pin [P]: 3.9 mm



Feed-through header - MDSTB 2,5/10-GF-5,08 - 1842445

PCB headers, nominal current: 10 A, rated voltage (III/2): 320 V, nominal cross section: 2.5 mm², number of positions: 10, pitch: 5.08 mm, color: green, contact surface: Tin, mounting: Wave soldering, pin layout: Linear pinning, solder pin [P]: 3.2 mm, The article can be aligned to create different nos. of positions! In combination with MVSTB or FKCV plug components, both an MVSTBW (or FKCVW) and an MVSTBR plug (or FKCVR) must be used. Combination with TMSTBP plug components is not possible!



Feed-through header - MDSTBV 2,5/10-GF-5,08 - 1845714

PCB headers, nominal current: 10 A, rated voltage (III/2): 320 V, nominal cross section: 2.5 mm², number of positions: 10, pitch: 5.08 mm, color: green, contact surface: Tin, mounting: Wave soldering, pin layout: Linear pinning, solder pin [P]: 3.9 mm, The article can be aligned to create different nos. of positions! In combination with MVSTB or FKCV plug components, both an MVSTBW (or FKCVW) and an MVSTBR plug (or FKCVR) must be used. Combination with TMSTBP plug components is not possible!



Printed-circuit board connector - DFK-MSTBA 2,5/10-GF-5,08 - 1899061



Feed-through header, nominal current: 12 A, rated voltage (III/2): 320 V, nominal cross section: 2.5 mm², number of positions: 10, pitch: 5.08 mm, color: green, contact surface: Tin, mounting: Wave soldering, pin layout: Linear pinning, solder pin [P]: 3.2 mm

Printed-circuit board connector - FKCVW 2,5/10-STF-5,08 - 1873883

Accessories

Printed-circuit board connector - DFK-MSTBVA 2,5/10-GF-5,08 - 1899362



Feed-through header, nominal current: 12 A, rated voltage (III/2): 320 V, nominal cross section: 2.5 mm², number of positions: 10, pitch: 5.08 mm, color: green, contact surface: Tin, mounting: Wave soldering, pin layout: Linear pinning, solder pin [P]: 3.9 mm

Printed-circuit board connector - CC 2,5/10-GF-5,08 P26THR - 1954773



PCB headers, nominal current: 12 A, rated voltage (III/2): 320 V, nominal cross section: 2.5 mm², number of positions: 10, pitch: 5.08 mm, color: black, contact surface: Tin, mounting: THR soldering, pin layout: Linear pinning, solder pin [P]: 2.6 mm, User information and design recommendations for through hole reflow technology can be found under: Downloads

Printed-circuit board connector - CC 2,5/10-GF-5,08 P26THRR88 - 1954883



PCB headers, nominal current: 12 A, rated voltage (III/2): 320 V, nominal cross section: 2.5 mm², number of positions: 10, pitch: 5.08 mm, color: black, contact surface: Tin, mounting: THR soldering, pin layout: Linear pinning, solder pin [P]: 2.6 mm, User information and design recommendations for through hole reflow technology can be found under: Downloads

Printed-circuit board connector - CCV 2,5/10-GF-5,08 P26THR - 1955714



PCB headers, nominal current: 12 A, rated voltage (III/2): 320 V, nominal cross section: 2.5 mm², number of positions: 10, pitch: 5.08 mm, color: black, contact surface: Tin, mounting: THR soldering, pin layout: Linear pinning, solder pin [P]: 2.6 mm, User information and design recommendations for through hole reflow technology can be found under: Downloads

Printed-circuit board connector - CCV 2,5/10-GF-5,08 P26THRR88 - 1955824



PCB headers, nominal current: 12 A, rated voltage (III/2): 320 V, nominal cross section: 2.5 mm², number of positions: 10, pitch: 5.08 mm, color: black, contact surface: Tin, mounting: THR soldering, pin layout: Linear pinning, solder pin [P]: 2.6 mm, User information and design recommendations for through hole reflow technology can be found under: Downloads

Phoenix Contact 2020 © - all rights reserved
<http://www.phoenixcontact.com>

PHOENIX CONTACT GmbH & Co. KG
Flachsmarktstr. 8
32825 Blomberg
Germany
Tel. +49 5235 300
Fax +49 5235 3 41200
<http://www.phoenixcontact.com>

Mouser Electronics

Authorized Distributor

Click to View Pricing, Inventory, Delivery & Lifecycle Information:

[Phoenix Contact:](#)

[1873883](#)