

Printed-circuit board connector - MC 1,5/19-ST-3,5 - 1840531

Please be informed that the data shown in this PDF Document is generated from our Online Catalog. Please find the complete data in the user's documentation. Our General Terms of Use for Downloads are valid (<http://phoenixcontact.com/download>)

PCB connector, nominal current: 8 A, rated voltage (III/2): 160 V, nominal cross section: 1.5 mm², number of positions: 19, pitch: 3.5 mm, connection method: Screw connection with tension sleeve, color: green, contact surface: Tin



The figure shows a 10-position version of the product

Your advantages

- Well-known connection principle allows worldwide use
- Low temperature rise, thanks to maximum contact force
- Allows connection of two conductors



Key Commercial Data

Packing unit	50 pc
GTIN	 4 017918 111687
GTIN	4017918111687

Technical data

Item properties

Brief article description	Printed-circuit board connector
Plug-in system	MINI COMBICON
Type of contact	Female connector
Range of articles	MC 1,5/...-ST
Pitch	3.5 mm
Number of positions	19
Connection method	Screw connection with tension sleeve
Drive form screw head	Slotted (L)
Screw thread	M2
Locking	without
Number of levels	1
Number of connections	19

Printed-circuit board connector - MC 1,5/19-ST-3,5 - 1840531

Technical data

Item properties

Number of potentials	19
----------------------	----

Electrical parameters

Nominal current	8 A
Nom. voltage	160 V
Rated voltage	160 V
Rated voltage (III/2)	160 V
Rated voltage (II/2)	320 V
Rated surge voltage (III/3)	2.5 kV
Rated surge voltage (III/2)	2.5 kV
Rated surge voltage (II/2)	2.5 kV

Connection capacity

Connection method	Screw connection with tension sleeve
pluggable	Yes
Conductor cross section solid	0.14 mm ² ... 1.5 mm ²
Conductor cross section flexible	0.14 mm ² ... 1.5 mm ²
Conductor cross section AWG / kcmil	28 ... 16
Conductor cross section flexible, with ferrule without plastic sleeve	0.25 mm ² ... 1.5 mm ²
Conductor cross section, flexible, with ferrule, with plastic sleeve	0.25 mm ² ... 0.5 mm ²
2 conductors with same cross section, solid	0.08 mm ² ... 0.5 mm ²
2 conductors with same cross section, flexible	0.08 mm ² ... 0.75 mm ²
2 conductors with same cross section, flexible, with ferrule without plastic sleeve	0.25 mm ² ... 0.34 mm ²
2 conductors with the same cross section, flexible, with TWIN ferrule with plastic sleeve	0.5 mm ² ... 0.5 mm ²
Cylindrical gauge a x b / diameter	2.4 mm x 1.5 mm / 1.6 mm
Stripping length	7 mm
Torque	0.22 Nm ... 0.25 Nm

Material data - contact

Note	WEEE/RoHS-compliant, free of whiskers according to IEC 60068-2-82/ JEDEC JESD 201
Contact material	Cu alloy
Surface characteristics	hot-dip tin-plated
Metal surface terminal point (top layer)	Tin (4 - 8 µm Sn)
Metal surface contact area (top layer)	Tin (4 - 8 µm Sn)

Material data - housing

Housing color	green (6021)
Insulating material	PA
Insulating material group	I
CTI according to IEC 60112	600
Flammability rating according to UL 94	V0

Printed-circuit board connector - MC 1,5/19-ST-3,5 - 1840531

Technical data

Material data - housing

Glow wire flammability index GWFI according to EN 60695-2-12	850
Glow wire ignition temperature GWIT according to EN 60695-2-13	775
Temperature for the ball pressure test according to EN 60695-10-2	125 °C

Dimensions for the product

Length [l]	16.1 mm
Width [w]	66.5 mm
Height [h]	11.1 mm
Pitch	3.5 mm
Height (without solder pin)	11.1 mm

Packaging information

Type of packaging	packed in cardboard
Pieces per package	50
Denomination packing units	Pcs.

Ambient conditions

Ambient temperature (storage/transport)	-40 °C ... 70 °C
Ambient temperature (assembly)	-5 °C ... 100 °C
Ambient temperature (operation)	-40 °C ... 100 °C (dependent on the derating curve)

Termination and connection method

Test for conductor damage and slackening	IEC 60999-1:1999-11
	Test passed

Pull-out test

Pull-out test	IEC 60999-1:1999-11
	Test passed
Conductor cross section / conductor type / tensile force	0.14 mm ² / solid / > 10 N
	0.14 mm ² / flexible / > 10 N
	1.5 mm ² / solid / > 40 N
	1.5 mm ² / flexible / > 40 N

Mechanical tests according to standard

Test specification	IEC 61984
Visual inspection	IEC 60512-1-1:2002-02
Dimension check	IEC 60512-1-2:2002-02
Resistance of inscriptions	IEC 60068-2-70:1995-12
Insertion and withdrawal force	IEC 60512-13-2:2006-02
No. of cycles	25
Insertion strength per pos. approx.	6 N
Withdraw strength per pos. approx.	4 N
Polarization and coding	IEC 60512-13-5:2006-02
Contact holder in insert	IEC 60512-15-1:2008-05

Printed-circuit board connector - MC 1,5/19-ST-3,5 - 1840531

Technical data

Mechanical tests according to standard

Test force per pos.	24.5 N
---------------------	--------

Air clearances and creepage distances

Clearances and creepage distances	IEC 60664-1:2007-04
Specification	IEC 60664-1:2007-04
Minimum clearance - inhomogeneous field (III/3)	1.5 mm
Minimum clearance - inhomogeneous field (III/2)	1.5 mm
Minimum clearance - inhomogeneous field (II/2)	1.5 mm
Minimum creepage distance value (III/3)	2 mm
Minimum creepage distance value (III/2)	1.5 mm
Minimum creepage distance value (II/2)	1.6 mm

Current carrying capacity / derating curves

Caption	Type: MC 1,5/...-ST-3,5 with MC 1,5/...-G-3,5
Specification	IEC 61984:2008-10
Reduction factor	0.8
Note	Representation based on IEC 60512-5-2:2002-02
	For number of positions, see diagram

Mechanical tests (A)

Test specification	IEC 61984
Insertion strength per pos. approx.	6 N
Withdraw strength per pos. approx.	4 N
Polarization when inserted requirement >20 N	Test passed
Contact holder in insert requirements >20 N	Test passed

Durability tests (B)

Specification	IEC 60512-9-1:2010-03
Contact resistance R ₁	1.3 mΩ
Insertion/withdrawal cycles	25
Contact resistance R ₂	1.4 mΩ
Impulse withstand voltage at sea level	2.95 kV
Power-frequency withstand voltage	1.39 kV
Insulation resistance, neighboring positions	> 1.6 TΩ

Thermal tests (C)

Specification	IEC 60512-5-1:2002-02
Number of positions	20
Conductor cross section	1.5 mm ²
Test current	8 A DC
Upper limiting temperature requirements <100 °C	Test passed

Climatic tests (D)

Specification	ISO 6988:1985-02
---------------	------------------

Printed-circuit board connector - MC 1,5/19-ST-3,5 - 1840531

Technical data

Climatic tests (D)

Cold stress	-40 °C/2 h
Thermal stress	100 °C/168 h
Corrosive stress	0.2 dm ³ SO ₂ on 300 dm ³ /40 °C/1 cycle
Impulse withstand voltage at sea level	2.95 kV
Power-frequency withstand voltage	1.39 kV

Environmental and durability tests (E)

Specification	IEC 61984:2008-10
Result, degree of protection, IP code	Finger safety with IP20 test finger

Environmental Product Compliance

REACH SVHC	Lead 7439-92-1
China RoHS	Environmentally Friendly Use Period = 50 years
	For details about hazardous substances go to tab "Downloads", Category "Manufacturer's declaration"

Drawings

Diagram

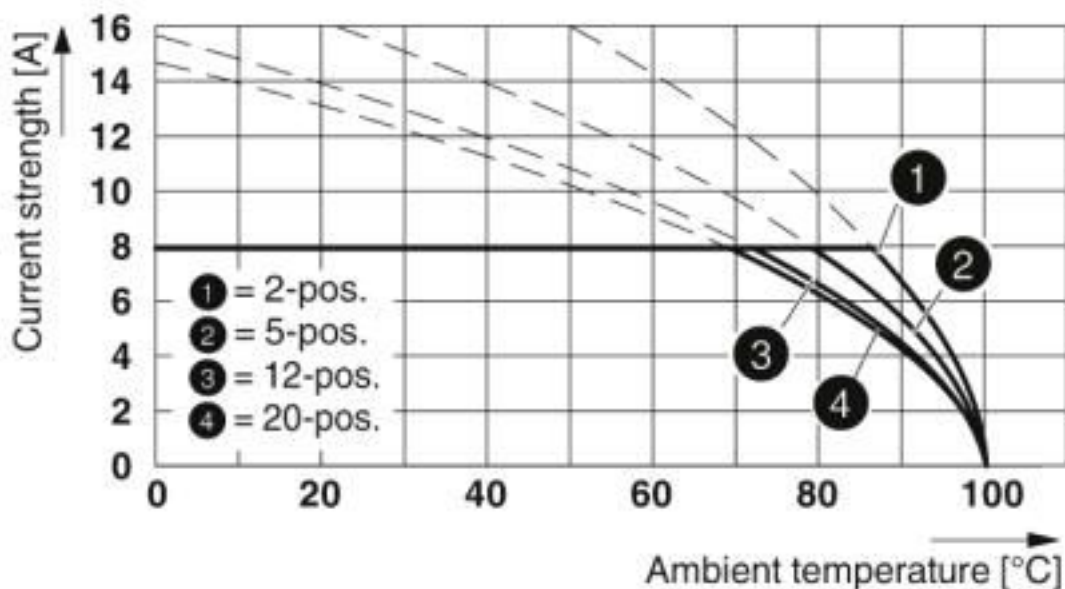

Type: MC 1,5/...-ST-3,5 with MC 1,5/...-G-3,5

Printed-circuit board connector - MC 1,5/19-ST-3,5 - 1840531

Diagram

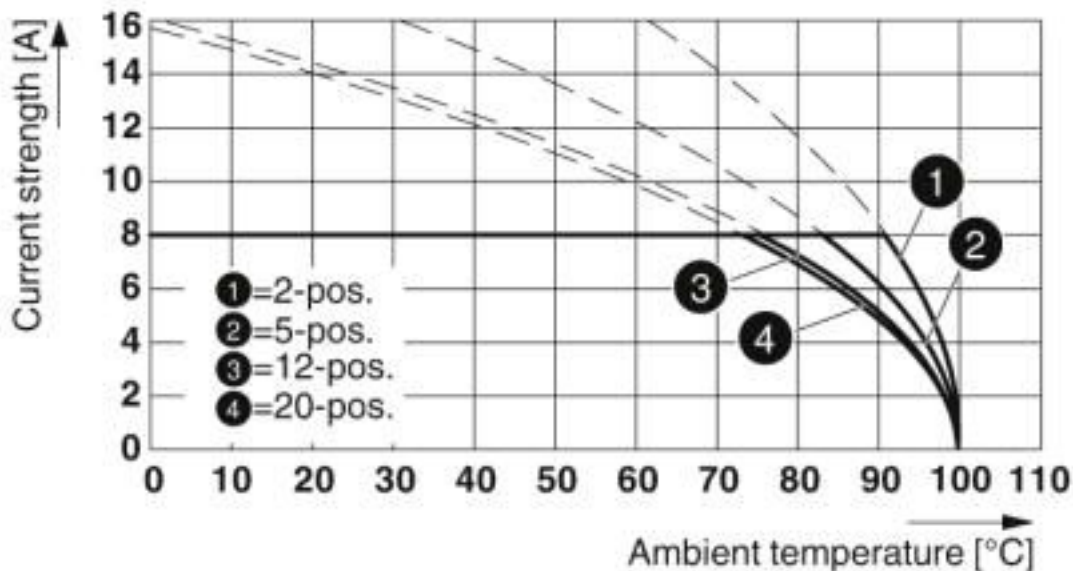

Type: MC 1,5/...-ST-3,5 with MCV 1,5/...-G-3,5

Diagram

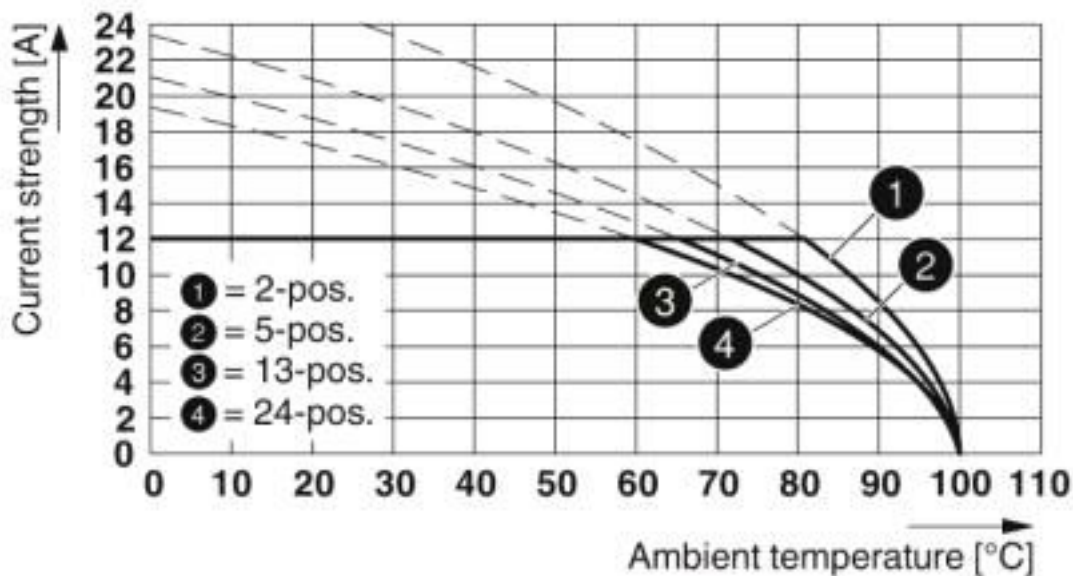

Type: MC 1,5/...-ST(F)-3,5 with MC 1,5/...-G(F)-3,5 P... THR

Printed-circuit board connector - MC 1,5/19-ST-3,5 - 1840531

Dimensional drawing

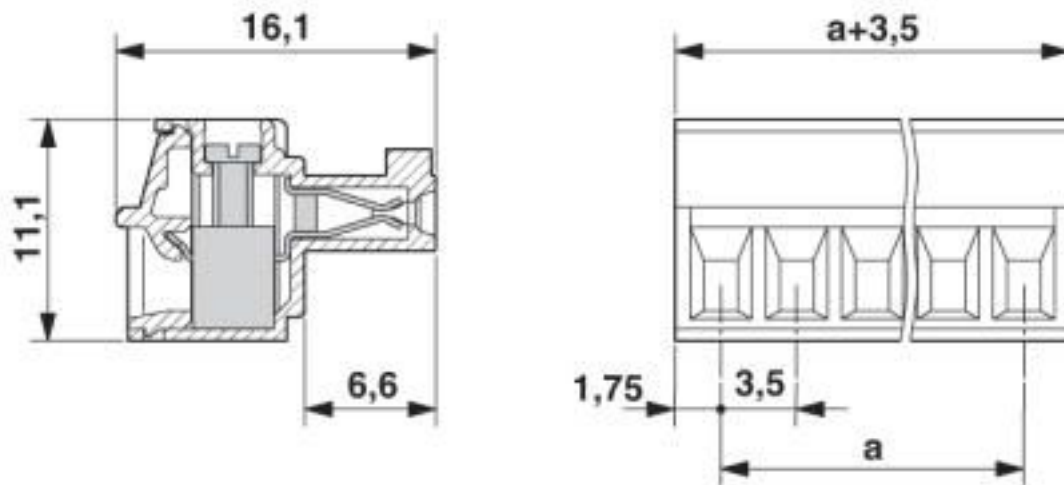

Classifications

eCl@ss

eCl@ss 10.0.1	27440309
eCl@ss 4.0	27260700
eCl@ss 4.1	27260700
eCl@ss 5.0	27260700
eCl@ss 5.1	27260700
eCl@ss 6.0	27260700
eCl@ss 7.0	27440309
eCl@ss 8.0	27440309
eCl@ss 9.0	27440309

ETIM

ETIM 3.0	EC001121
ETIM 4.0	EC002638
ETIM 5.0	EC002638
ETIM 6.0	EC002638
ETIM 7.0	EC002638

UNSPSC

UNSPSC 6.01	30211810
UNSPSC 7.0901	39121409
UNSPSC 11	39121409
UNSPSC 12.01	39121409
UNSPSC 13.2	39121409
UNSPSC 18.0	39121409
UNSPSC 19.0	39121409
UNSPSC 20.0	39121409

Printed-circuit board connector - MC 1,5/19-ST-3,5 - 1840531

Classifications

UNSPSC

UNSPSC 21.0	39121409
-------------	----------

Approvals

Approvals

Approvals

CSA / IEC EE CB Scheme / VDE Gutachten mit Fertigungsüberwachung / EAC / cULus Recognized

Ex Approvals

Approval details

CSA		http://www.csagroup.org/services-industries/product-listing/	13631
		B	D
Nominal voltage UN		300 V	300 V
Nominal current IN		8 A	8 A
mm ² /AWG/kcmil		28-16	28-16

IECEE CB Scheme		http://www.iecee.org/	DE1-60987-B1B2
Nominal voltage UN		160 V	
Nominal current IN		8 A	
mm ² /AWG/kcmil		0.2-1.5	

VDE Gutachten mit Fertigungsüberwachung		http://www2.vde.com/de/Institut/Online-Service/VDE-gepruefteProdukte/Seiten/Online-Suche.aspx	40011723
Nominal voltage UN		160 V	
Nominal current IN		8 A	
mm ² /AWG/kcmil		0.2-1.5	

EAC			B.01687
-----	---	--	---------

Printed-circuit board connector - MC 1,5/19-ST-3,5 - 1840531

Approvals

cULus Recognized		http://database.ul.com/cgi-bin/XYV/template/LISEXT/1FRAME/index.htm	E60425-20110128
	B	D	
Nominal voltage UN	300 V	300 V	
Nominal current IN	8 A	8 A	
mm ² /AWG/kcmil	30-14	30-14	

Accessories

Accessories

Labeled terminal marker

Marker card - SK 3,5/2,8:FORTL.ZAHLEN - 0804073



Marker card, Card, white, labeled, horizontal: consecutive numbers 1 ... 10, 11 ... 20, etc. up to 91 ... 99, mounting type: adhesive, for terminal block width: 3.5 mm, lettering field size: 3.5 x 2.8 mm

Marker pen

Marker pen - B-STIFT - 1051993



Marker pen, for manual labeling of unprinted Zack strips, smear-proof and waterproof, line thickness 0.5 mm

Screwdriver tools

Screwdriver - SZS 0,4X2,5 VDE - 1205037



Screwdriver, slot-headed, VDE insulated, size: 0.4 x 2.5 x 80 mm, 2-component grip, with non-slip grip

Terminal marking

Printed-circuit board connector - MC 1,5/19-ST-3,5 - 1840531

Accessories

Marker card - SK U/2,8 WH:UNBEDRUCKT - 0803883



Marker card, Sheet, white, unlabeled, can be labeled with: PLOTMARK, CMS-P1-PLOTTER, Office printing systems, mounting type: adhesive, for terminal block width: 210 mm, lettering field size: 186 x 2.8 mm, Number of individual labels: 3600

Additional products

Printed-circuit board connector - MCV 1,5/19-G-3,5 - 1843774



PCB headers, nominal current: 8 A, rated voltage (III/2): 160 V, nominal cross section: 1.5 mm², number of positions: 19, pitch: 3.5 mm, color: green, contact surface: Tin, mounting: Wave soldering, pin layout: Linear pinning, solder pin [P]: 3.4 mm

Feed-through header - MC 1,5/19-G-3,5 - 1844388



PCB headers, nominal current: 8 A, rated voltage (III/2): 160 V, nominal cross section: 1.5 mm², number of positions: 19, pitch: 3.5 mm, color: green, contact surface: Tin, mounting: Wave soldering, pin layout: Linear pinning, solder pin [P]: 3.4 mm

Printed-circuit board connector - MCDNV 1,5/19-G1-3,5 P26THR - 1952953



PCB headers, nominal current: 8 A, rated voltage (III/2): 160 V, nominal cross section: 1.5 mm², number of positions: 19, pitch: 3.5 mm, color: black, contact surface: Tin, mounting: THR soldering, pin layout: Linear pinning, solder pin [P]: 2.6 mm, The pin length is 26 mm. User information and design recommendations on Through Hole Reflow Technology can be found at: [http: "Downloads"](http://Downloads).

Printed-circuit board connector - MCDNV 1,5/19-G1-3,5 P14THR - 1953185



PCB headers, nominal current: 8 A, rated voltage (III/2): 160 V, nominal cross section: 1.5 mm², number of positions: 19, pitch: 3.5 mm, color: black, contact surface: Tin, mounting: THR soldering, pin layout: Linear pinning, solder pin [P]: 1.4 mm, The pin length is 1.4 mm. User information and design recommendations on Through Hole Reflow Technology can be found at: [Downloads](#)".

Printed-circuit board connector - MC 1,5/19-ST-3,5 - 1840531

Accessories

Feed-through header - MCDN 1,5/19-G1-3,5 P26THR - 1953884



PCB headers, nominal current: 8 A, rated voltage (III/2): 160 V, nominal cross section: 1.5 mm², number of positions: 19, pitch: 3.5 mm, color: black, contact surface: Tin, mounting: THR soldering, pin layout: Linear pinning, solder pin [P]: 2.6 mm, The pin length is 2.6 mm. User information and design recommendations on Through Hole Reflow Technology can be found at: "Downloads"

Feed-through header - MCDN 1,5/19-G1-3,5 P14THR - 1954100



PCB headers, nominal current: 8 A, rated voltage (III/2): 160 V, nominal cross section: 1.5 mm², number of positions: 19, pitch: 3.5 mm, color: black, contact surface: Tin, mounting: THR soldering, pin layout: Linear pinning, solder pin [P]: 1.4 mm, The pin length is 1.4 mm. User information and design recommendations on Through Hole Reflow Technology can be found at: "Downloads".

Phoenix Contact 2020 © - all rights reserved
<http://www.phoenixcontact.com>

PHOENIX CONTACT GmbH & Co. KG
Flachsmarktstr. 8
32825 Blomberg
Germany
Tel. +49 5235 300
Fax +49 5235 3 41200
<http://www.phoenixcontact.com>

Mouser Electronics

Authorized Distributor

Click to View Pricing, Inventory, Delivery & Lifecycle Information:

[Phoenix Contact:](#)

[1840531](#)