

Printed-circuit board connector - SMC 1,5/14-G-3,81 - 1827392

Please be informed that the data shown in this PDF Document is generated from our Online Catalog. Please find the complete data in the user's documentation. Our General Terms of Use for Downloads are valid (<http://phoenixcontact.com/download>)

PCB headers, nominal current: 8 A, rated voltage (III/2): 160 V, nominal cross section: 1.5 mm², number of positions: 14, pitch: 3.81 mm, color: green, contact surface: Tin, mounting: Wave soldering, pin layout: Linear pinning, solder pin [P]: 3.4 mm



The figure shows a 10-position version of the product

Your advantages

- Well-known mounting principle allows worldwide use
- Angled connection enables multi-row arrangement on the PCB
- Maximum flexibility when it comes to device design – one header for connectors with different connection technologies



Key Commercial Data

Packing unit	50 pc
GTIN	 4 017918 114510
GTIN	4017918114510

Technical data

Dimensions

Length [l]	13.1 mm
Width	54.73 mm
Pitch	3.81 mm
Dimension a	49.53 mm
Width [w]	54.73 mm
Height [h]	14.4 mm
Installed height	11 mm
Length of the solder pin	3.4 mm
Pin dimensions	0.8 x 0.8 mm
Length	13.1 mm

General

Printed-circuit board connector - SMC 1,5/14-G-3,81 - 1827392

Technical data

General

Range of articles	SMC 1,5/...-G
Insulating material group	I
Rated surge voltage (III/3)	2.5 kV
Rated surge voltage (III/2)	2.5 kV
Rated surge voltage (II/2)	2.5 kV
Rated voltage (III/3)	160 V
Rated voltage (III/2)	160 V
Rated voltage (II/2)	320 V
Connection in acc. with standard	EN-VDE
Nominal current I_N	8 A
Maximum load current	8 A
Insulating material	PA
Flammability rating according to UL 94	V0
Color	green
Number of positions	14

Standards and Regulations

Connection in acc. with standard	EN-VDE
	CSA
Flammability rating according to UL 94	V0

Environmental Product Compliance

China RoHS	Environmentally friendly use period: unlimited = EFUP-e
	No hazardous substances above threshold values

Drawings

Printed-circuit board connector - SMC 1,5/14-G-3,81 - 1827392

Drilling diagram

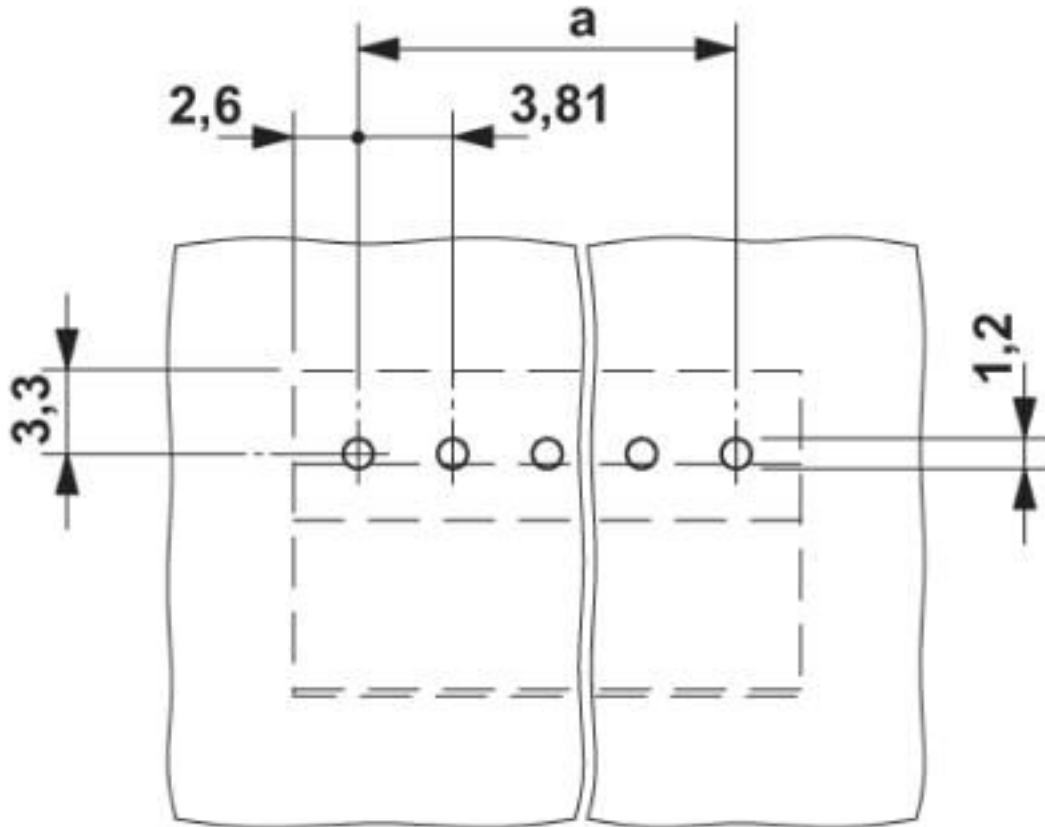

Diagram

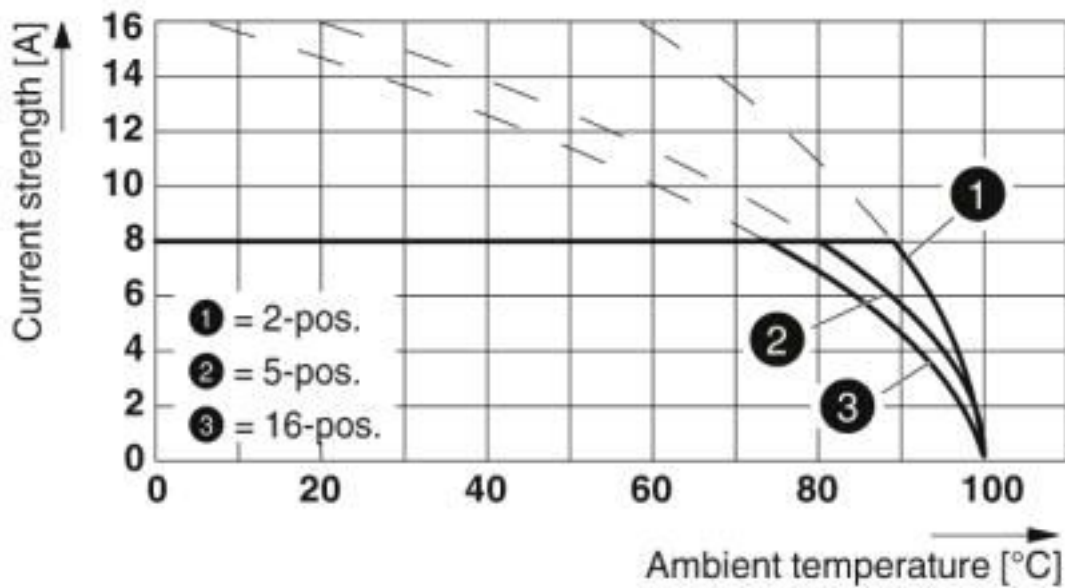

Type: FRONT-MC 1,5/...-ST-3,81 with SMC 1,5/...-G-3,81

Printed-circuit board connector - SMC 1,5/14-G-3,81 - 1827392

Dimensional drawing

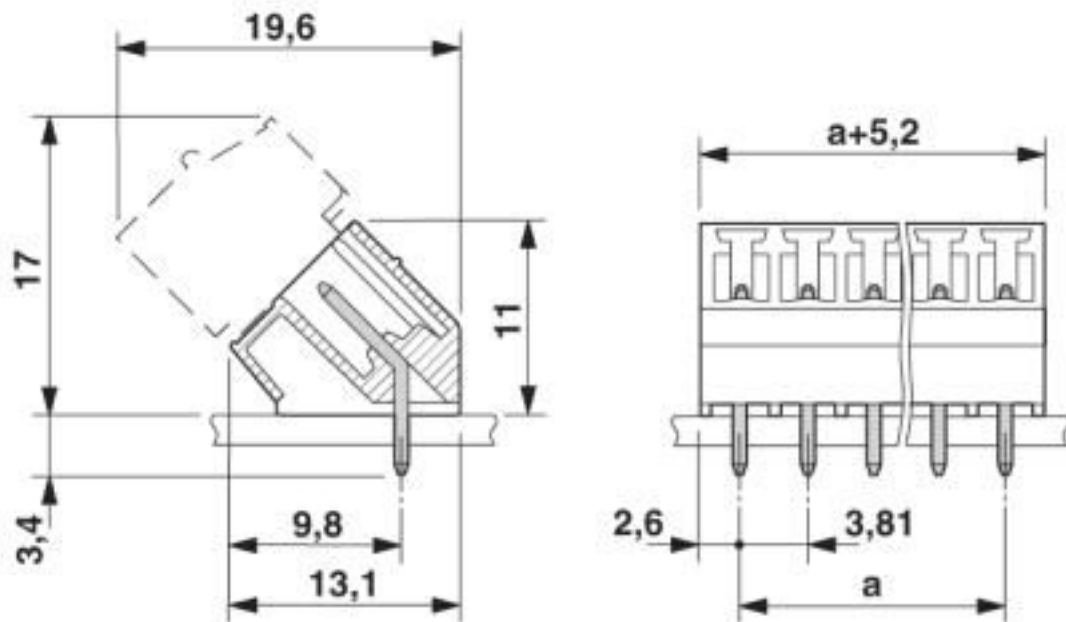

Classifications

eCl@ss

eCl@ss 10.0.1	27440402
eCl@ss 4.0	27260700
eCl@ss 4.1	27260700
eCl@ss 5.0	27260700
eCl@ss 5.1	27260700
eCl@ss 6.0	27260700
eCl@ss 7.0	27440402
eCl@ss 8.0	27440402
eCl@ss 9.0	27440402

ETIM

ETIM 3.0	EC001121
ETIM 4.0	EC002637
ETIM 5.0	EC002637
ETIM 6.0	EC002637
ETIM 7.0	EC002637

UNSPSC

UNSPSC 6.01	30211810
UNSPSC 7.0901	39121409
UNSPSC 11	39121409
UNSPSC 12.01	39121409

Printed-circuit board connector - SMC 1,5/14-G-3,81 - 1827392

Classifications

UNSPSC

UNSPSC 13.2	39121409
UNSPSC 18.0	39121409
UNSPSC 19.0	39121409
UNSPSC 20.0	39121409
UNSPSC 21.0	39121409

Approvals

Approvals

Approvals

CSA / IEC EE CB Scheme / VDE Gutachten mit Fertigungsüberwachung / EAC / cULus Recognized

Ex Approvals

Approval details

CSA		http://www.csagroup.org/services-industries/product-listing/	13631
	B	D	
Nominal voltage UN	300 V	300 V	
Nominal current IN	8 A	8 A	

IECEE CB Scheme		http://www.iecee.org/	DE1-60987-B1B2
Nominal voltage UN	160 V		
Nominal current IN	8 A		

VDE Gutachten mit Fertigungsüberwachung		http://www2.vde.com/de/Institut/Online-Service/VDE-gepruefteProdukte/Seiten/Online-Suche.aspx	40011723
Nominal voltage UN	160 V		
Nominal current IN	8 A		

Printed-circuit board connector - SMC 1,5/14-G-3,81 - 1827392

Approvals

EAC		B.01687
-----	--	---------

cULus Recognized		http://database.ul.com/cgi-bin/XYV/template/LISEXT/1FRAME/index.htm	E60425-20110128
	B	D	
Nominal voltage UN	300 V	300 V	
Nominal current IN	8 A	8 A	

Accessories

Accessories

Coding element

Coding profile - CP-MSTB - 1734634



Coding profile, is inserted into the slot on the plug or inverted header, red insulating material

Labeled terminal marker

Marker card - SK 3,81/2,8:FORTL.ZAHLEN - 0804109



Marker card, Card, white, labeled, horizontal: consecutive numbers 1 ... 10, 11 ... 20, etc. up to 91 ... (99)100, mounting type: adhesive, for terminal block width: 3.81 mm, lettering field size: 3.81 x 2.8 mm

Marker pen

Marker pen - B-STIFT - 1051993



Marker pen, for manual labeling of unprinted Zack strips, smear-proof and waterproof, line thickness 0.5 mm

Terminal marking

Printed-circuit board connector - SMC 1,5/14-G-3,81 - 1827392

Accessories

Marker card - SK U/2,8 WH:UNBEDRUCKT - 0803883



Marker card, Sheet, white, unlabeled, can be labeled with: PLOTMARK, CMS-P1-PLOTTER, Office printing systems, mounting type: adhesive, for terminal block width: 210 mm, lettering field size: 186 x 2.8 mm, Number of individual labels: 3600

Additional products

Printed-circuit board connector - FMC 1,5/14-ST-3,81 - 1748095



PCB connector, nominal current: 8 A, rated voltage (III/2): 160 V, nominal cross section: 1.5 mm², number of positions: 14, pitch: 3.81 mm, connection method: Push-in spring connection, color: green, contact surface: Tin

Printed-circuit board connector - MC 1,5/14-ST-3,81 - 1803691



PCB connector, nominal current: 8 A, rated voltage (III/2): 160 V, nominal cross section: 1.5 mm², number of positions: 14, pitch: 3.81 mm, connection method: Screw connection with tension sleeve, color: green, contact surface: Tin

Printed-circuit board connector - MCVW 1,5/14-ST-3,81 - 1827091



PCB connector, nominal current: 8 A, rated voltage (III/2): 160 V, nominal cross section: 1.5 mm², number of positions: 14, pitch: 3.81 mm, connection method: Screw connection with tension sleeve, color: green, contact surface: Tin

Printed-circuit board connector - MCVR 1,5/14-ST-3,81 - 1827240



PCB connector, nominal current: 8 A, rated voltage (III/2): 160 V, nominal cross section: 1.5 mm², number of positions: 14, pitch: 3.81 mm, connection method: Screw connection with tension sleeve, color: green, contact surface: Tin

Printed-circuit board connector - SMC 1,5/14-G-3,81 - 1827392

Accessories

Printed-circuit board connector - FRONT-MC 1,5/14-ST-3,81 - 1850783



PCB connector, nominal current: 8 A, rated voltage (III/2): 160 V, nominal cross section: 1.5 mm², number of positions: 14, pitch: 3.81 mm, connection method: Front screw connection, color: green, contact surface: Tin

Printed-circuit board connector - FK-MCP 1,5/14-ST-3,81 - 1851164



PCB connector, nominal current: 8 A, rated voltage (III/2): 160 V, nominal cross section: 1.5 mm², number of positions: 14, pitch: 3.81 mm, connection method: Push-in spring connection, color: green, contact surface: Tin

Printed-circuit board connector - MCC 1/14-STZ-3,81 - 1852299



PCB connector, nominal current: 8 A, rated voltage (III/2): 160 V, nominal cross section: 1 mm², number of positions: 14, pitch: 3.81 mm, connection method: Crimp connection, color: green, Corresponding female crimp contacts with current [A] and conductor cross section range [mm²] data: 5A/MCC-MT 0,2-0,35 (1859988); 8A/MCC-MT 0,5-1,0 (1859991)

Printed-circuit board connector - QC 0,5/14-ST-3,81 - 1897513



PCB connector, nominal current: 6 A, rated voltage (III/2): 200 V, nominal cross section: 0.5 mm², number of positions: 14, pitch: 3.81 mm, connection method: Displacement connection, color: green, contact surface: Tin

Mouser Electronics

Authorized Distributor

Click to View Pricing, Inventory, Delivery & Lifecycle Information:

[Phoenix Contact:](#)

[1827392](#)