

PCB terminal block - SPT-THR 1,5/10-H-5,08 P26 - 1823162

Please be informed that the data shown in this PDF Document is generated from our Online Catalog. Please find the complete data in the user's documentation. Our General Terms of Use for Downloads are valid (<http://phoenixcontact.com/download>)

PCB terminal block, nominal current: 13.5 A, rated voltage (III/2): 320 V, nominal cross section: 1.5 mm², pitch: 5.08 mm, number of positions: 10, connection method: Push-in spring connection, mounting: THR soldering, conductor/PCB connection direction: 0 °, color: black, Pin layout: Linear double pinning, Solder pin [P]: 2.6 mm



Your advantages

- ✓ Time saving push-in connection, tools not required
- ✓ Defined contact force ensures that contact remains stable over the long term
- ✓ Intuitive use through colour coded actuation lever
- ✓ Designed for integration into the SMT soldering process
- ✓ Quick and convenient testing using integrated test option
- ✓ Operation and conductor connection from one direction enable integration into front of device
- ✓ Two solder pins reduce the mechanical strain on the soldering spots

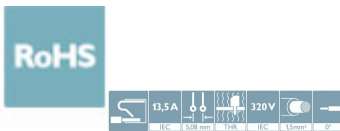

Key Commercial Data

Packing unit	40 pc
Minimum order quantity	40 pc
GTIN	 4 046356 811903
GTIN	4046356811903

Technical data

Item properties

Brief article description	PCB terminal block
Range of articles	SPT 1,5/...-H-THR
Pitch	5.08 mm
Number of positions	10
Connection method	Push-in spring connection
Mounting type	THR soldering
Pin layout	Linear double pinning
Number of levels	1

PCB terminal block - SPT-THR 1,5/10-H-5,08 P26 - 1823162

Technical data

Item properties

Number of connections	10
Number of potentials	10

Electrical parameters

Nominal current	13.5 A
Nom. voltage	320 V
Rated voltage	250 V
Rated voltage (III/2)	320 V
Rated voltage (II/2)	500 V
Rated surge voltage (III/3)	4 kV
Rated surge voltage (III/2)	4 kV
Rated surge voltage (II/2)	4 kV

Connection capacity

Connection method	Push-in spring connection
Conductor cross section solid	0.2 mm ² ... 1.5 mm ²
Conductor cross section flexible	0.2 mm ² ... 1.5 mm ²
Conductor cross section AWG / kcmil	24 ... 16
Conductor cross section flexible, with ferrule without plastic sleeve	0.2 mm ² ... 1.5 mm ²
Conductor cross section, flexible, with ferrule, with plastic sleeve	0.2 mm ² ... 0.75 mm ²
Stripping length	8 mm

Material data - contact

Note	WEEE/RoHS-compliant, free of whiskers according to IEC 60068-2-82/ JEDEC JESD 201
Contact material	Cu alloy
Surface characteristics	hot-dip tin-plated
Metal surface terminal point (top layer)	Tin (4 - 8 µm Sn)
Metal surface soldering area (top layer)	Tin (4 - 8 µm Sn)

Material data - housing

Housing color	black (9005)
Insulating material	LCP
Insulating material group	IIIa
CTI according to IEC 60112	175
Flammability rating according to UL 94	V0

Dimensions for the product

Length [l]	13.6 mm
Width [w]	49.72 mm
Height [h]	10.3 mm
Pitch	5.08 mm
Height (without solder pin)	7.7 mm
Solder pin [P]	2.6 mm

PCB terminal block - SPT-THR 1,5/10-H-5,08 P26 - 1823162

Technical data

Dimensions for the product

Pin spacing	7 mm
Pin dimensions	0.7 x 0.3 mm

Dimensions for PCB design

Hole diameter	1.1 mm
Pin spacing	7 mm

Packaging information

Type of packaging	packed in cardboard
Pieces per package	40
Denomination packing units	Pcs.

General product information

Type of note	Assembly instruction:
Note	This item is not suitable for PCB cleaning with liquids.

Processing notes

Process	Reflow/wave soldering
Specification	Following IPC/JEDEC J-STD-020D.1:2008-03
	Following IEC 61760-1:2006-04
	Following IEC 60068-2-58:2005-02
Moisture Sensitive Level	MSL 1
Classification temperature T _c	260 °C
Solder cycles in the reflow	3

Ambient conditions

Ambient temperature (storage/transport)	-40 °C ... 70 °C
Ambient temperature (assembly)	-5 °C ... 100 °C
Ambient temperature (operation)	-40 °C ... 100 °C (Depending on the current carrying capacity/derating curve)

Termination and connection method

Connection test	IEC 60998-2-2:2002-12
Test result	Test passed
Test for conductor damage and slackening	IEC 60998-2-2:2002-12
	Test passed

Pull-out test

Pull-out test	IEC 60998-2-2:2002-12
	Test passed
Conductor cross section / conductor type / tensile force	0.2 mm ² / solid / > 10 N
	0.2 mm ² / flexible / > 10 N
	1.5 mm ² / solid / > 40 N
	1.5 mm ² / flexible / > 40 N

Mechanical tests according to standard

PCB terminal block - SPT-THR 1,5/10-H-5,08 P26 - 1823162

Technical data

Mechanical tests according to standard

Test specification	IEC 60998-2-2 (in parts)
--------------------	--------------------------

Electrical tests

Rated current	13.5 A
Conductor cross section	1.5 mm ²
Rated voltage (III/2)	320 V
Rated surge voltage (III/2)	4 kV

Air clearances and creepage distances

Clearances and creepage distances	IEC 60947-7-4:2013-08
Specification	IEC 60947-7-4:2013-08
Minimum clearance - inhomogeneous field (III/3)	3 mm
Minimum clearance - inhomogeneous field (III/2)	3 mm
Minimum clearance - inhomogeneous field (II/2)	3 mm
Minimum creepage distance value (III/3)	4 mm
Minimum creepage distance value (III/2)	3.2 mm
Minimum creepage distance value (II/2)	5 mm

Temperature-rise test

Specification	IEC 60998-2-1:2002-12
Result	Test passed
Requirement temperature-rise test	Increase in temperature ≤ 45 K

Current carrying capacity / derating curves

Caption	Type: SPT-THR 1,5/ 5-H-5,0(5,08) P26 Tested according to DIN EN 60512-5-2:2003-01 Reduction factor = 1 Number of positions: 5
Specification	Following IEC 60512-5-2:2002-02
Number of positions	5
Reduction factor	1

Vibration test

Specification	IEC 60068-2-6:2007-12
Result	Test passed
Frequency	10 - 150 - 10 Hz
Sweep speed	1 octave/min
Amplitude	0.35 mm (10 - 60.1 Hz)
Acceleration	5 g (60.1 - 150 Hz)
Test duration per axis	2.5 h

Resistance to ageing, humidity and penetration of solids

Dry heat	168 h/100°C
Humid heat	48 h/30 °C/92 %

Insulation resistance

PCB terminal block - SPT-THR 1,5/10-H-5,08 P26 - 1823162

Technical data

Insulation resistance

Specification	IEC 60998-1:2002-12
Result	Test passed
Insulation resistance, neighboring positions	9 TΩ

Glow-wire test

Specification	IEC 60998-1:2002-12
Result	Test passed
Temperature	850 °C
Time of exposure	5 s

Mechanical strength/tumbling barrel test

Specification	IEC 60998-1:2002-12
Height of fall	50 cm
Number of drop cycles	50
Rotation speed	5 rpm

Standards and Regulations

Connection in acc. with standard	EN-VDE
Flammability rating according to UL 94	V0

Environmental Product Compliance

China RoHS	Environmentally friendly use period: unlimited = EFUP-e
	No hazardous substances above threshold values

Drawings

PCB terminal block - SPT-THR 1,5/10-H-5,08 P26 - 1823162

Drilling diagram

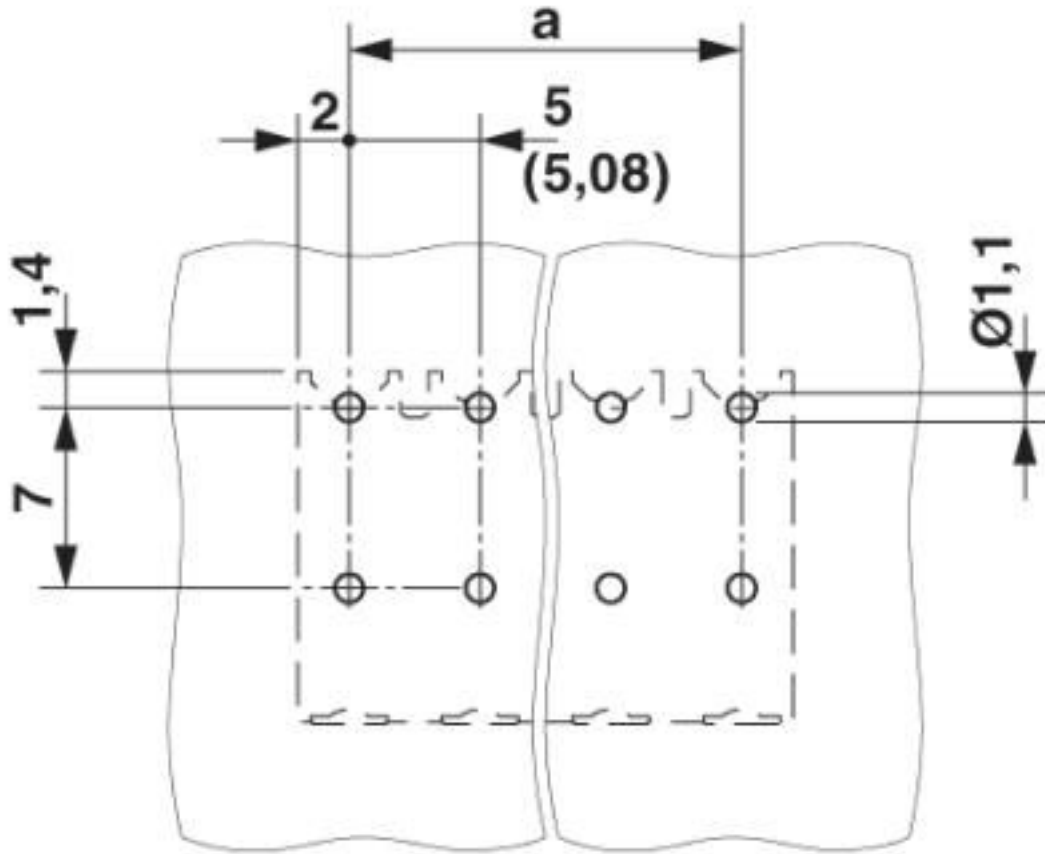

Diagram

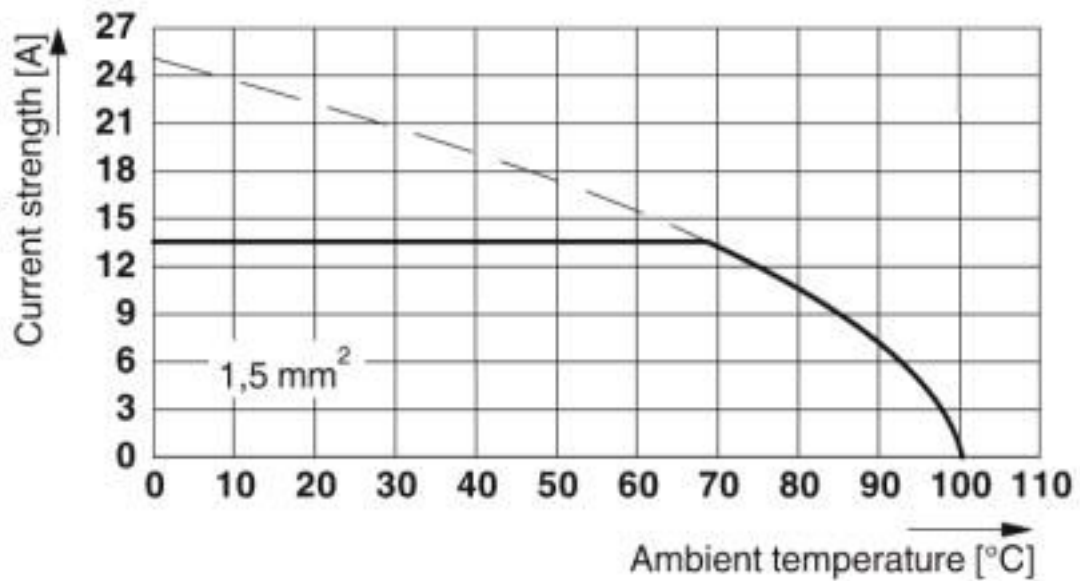

PCB terminal block - SPT-THR 1,5/10-H-5,08 P26 - 1823162

Tested according to DIN EN 60512-5-2:2003-01

Reduction factor = 1

Number of positions: 5

Dimensional drawing

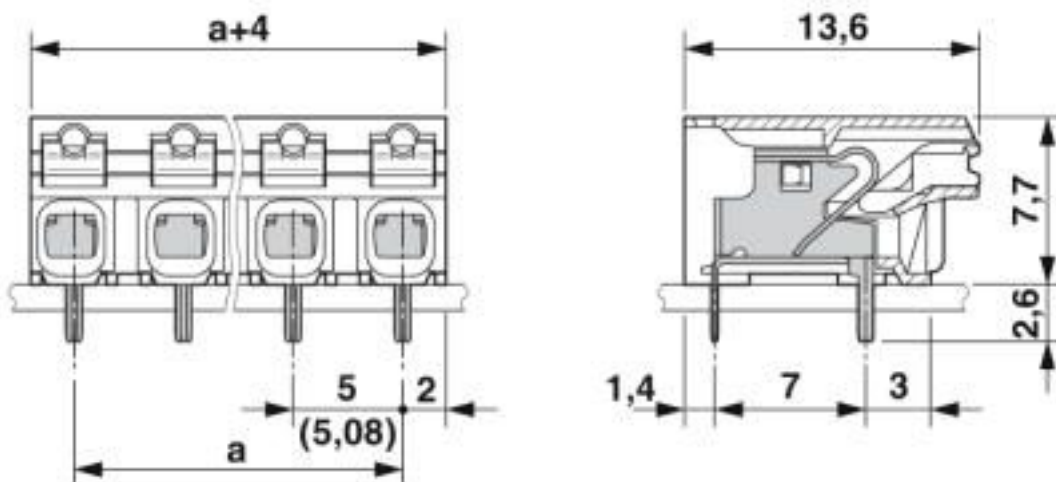

Classifications

eCl@ss

eCl@ss 10.0.1	27440401
eCl@ss 4.0	27141100
eCl@ss 4.1	27141100
eCl@ss 5.0	27141100
eCl@ss 5.1	27261100
eCl@ss 6.0	27261100
eCl@ss 7.0	27440401
eCl@ss 8.0	27440401
eCl@ss 9.0	27440401

ETIM

ETIM 3.0	EC001121
ETIM 4.0	EC002643
ETIM 5.0	EC002643
ETIM 6.0	EC002643
ETIM 7.0	EC002643

UNSPSC

UNSPSC 6.01	30211801
UNSPSC 7.0901	39121432
UNSPSC 11	39121432
UNSPSC 12.01	39121432
UNSPSC 13.2	39121432

PCB terminal block - SPT-THR 1,5/10-H-5,08 P26 - 1823162

Classifications

UNSPSC

UNSPSC 18.0	39121432
UNSPSC 19.0	39121432
UNSPSC 20.0	39121432
UNSPSC 21.0	39121432

Approvals

Approvals

Approvals

IECEE CB Scheme / VDE Zeichengenehmigung / EAC / cULus Recognized

Ex Approvals

Approval details

IECEE CB Scheme		http://www.iecee.org/	DE1-60621
Nominal voltage UN	320 V		
Nominal current IN	13.5 A		
mm ² /AWG/kcmil	0.2-1.5		

VDE Zeichengenehmigung		http://www2.vde.com/de/Institut/Online-Service/VDE-gepruefteProdukte/Seiten/Online-Suche.aspx	40046113
Nominal voltage UN	320 V		
Nominal current IN	13.5 A		
mm ² /AWG/kcmil	0.2-1.5		

EAC		B.01687
-----	---	---------

PCB terminal block - SPT-THR 1,5/10-H-5,08 P26 - 1823162

Approvals

cULus Recognized		http://database.ul.com/cgi-bin/XYV/template/LISEXT/1FRAME/index.htm	E60425-20061129
	B	D	
Nominal voltage UN	300 V	300 V	
Nominal current IN	10 A	10 A	
mm ² /AWG/kcmil	24-16	24-16	

Accessories

Accessories

Cable end sleeve

Ferrule - A 0,5 - 8 - 3202481



Ferrule, length: 8 mm, color: silver

Ferrule - A 0,75- 8 - 3202504



Ferrule, length: 8 mm, color: silver

Ferrule - A 1 - 8 - 3202517



Ferrule, length: 8 mm, color: silver

Ferrule - AI 0,25- 8 YE - 3203037



Ferrule, sleeve length: 8 mm, length: 12.5 mm, color: yellow

PCB terminal block - SPT-THR 1,5/10-H-5,08 P26 - 1823162

Accessories

Ferrule - AI 0,5 - 8 WH - 3200014



Ferrule, sleeve length: 8 mm, length: 14 mm, color: white

Ferrule - AI 0,5 - 8 WH -1000 - 3200881



Ferrule, sleeve length: 8 mm, length: 14 mm, color: white

Ferrule - AI 0,75- 8 GY - 3200519



Ferrule, sleeve length: 8 mm, length: 14 mm, color: gray

Ferrule - AI 0,75- 8 GY -1000 - 3200894



Ferrule, sleeve length: 8 mm, length: 14 mm, color: gray

Crimping tool

Crimping pliers - CRIMPFOX 6 - 1212034



Crimping pliers, for ferrules without insulating collar according to DIN 46228 Part 1 and ferrules with insulating collar according to DIN 46228 Part 4, 0.25 mm² ... 6.0 mm², lateral entry, trapezoidal crimp

Screwdriver tools

PCB terminal block - SPT-THR 1,5/10-H-5,08 P26 - 1823162

Accessories

Screwdriver - SZS 0,4X2,5 VDE - 1205037



Screwdriver, slot-headed, VDE insulated, size: 0.4 x 2.5 x 80 mm, 2-component grip, with non-slip grip

Phoenix Contact 2020 © - all rights reserved
<http://www.phoenixcontact.com>

PHOENIX CONTACT GmbH & Co. KG
Flachsmarktstr. 8
32825 Blomberg
Germany
Tel. +49 5235 300
Fax +49 5235 3 41200
<http://www.phoenixcontact.com>

Mouser Electronics

Authorized Distributor

Click to View Pricing, Inventory, Delivery & Lifecycle Information:

[Phoenix Contact:](#)

[1823162](#)