

Feed-through header - ICV 2,5/ 8-GF-5,08 EX - 1810502

Please be informed that the data shown in this PDF Document is generated from our Online Catalog. Please find the complete data in the user's documentation. Our General Terms of Use for Downloads are valid (<http://phoenixcontact.com/download>)

PCB headers, nominal current: 12 A, nominal cross section: 2.5 mm², number of positions: 8, pitch: 5.08 mm, color: green, contact surface: Tin, mounting: Wave soldering, pin layout: Linear pinning, solder pin [P]: 3.6 mm



The figure shows a 10-position version of the product

Your advantages

- ✓ Maximum flexibility when it comes to device design – one header for connectors with different connection technologies
- ✓ Easy PCB replacement thanks to plug-in modules
- ✓ Screwable flange for superior mechanical stability
- ✓ Satisfies the more stringent safety requirements of “Ex eb” protection according to IEC 60079-7 for potentially explosive areas



Key Commercial Data

Packing unit	50 pc
GTIN	
GTIN	4046356706834

Technical data

Dimensions

Length [l]	10.2 mm
Width	50.76 mm
Pitch	5.08 mm
Dimension a	5.08 mm
Width [w]	50.76 mm
Height [h]	22.6 mm
Installed height	19 mm
Length of the solder pin	3.6 mm
Pin dimensions	1.2 x 0.5 mm
Pin spacing	5.08 mm
Length	10.2 mm

Feed-through header - ICV 2,5/ 8-GF-5,08 EX - 1810502

Technical data

General

Range of articles	ICV 2,5/...-GF-EX
Insulating material group	I
Rated surge voltage (III/3)	4 kV
Rated surge voltage (III/2)	4 kV
Rated surge voltage (II/2)	4 kV
Rated voltage (III/3)	320 V
Rated voltage (III/2)	320 V
Rated voltage (II/2)	630 V
Connection in acc. with standard	EN-VDE
Nominal current I_N	12 A
Maximum load current	12 A
Insulating material	PA
Flammability rating according to UL 94	V0
Color	green
Number of positions	8

Standards and Regulations

Connection in acc. with standard	EN-VDE
Flammability rating according to UL 94	V0

Environmental Product Compliance

REACH SVHC	Lead 7439-92-1
China RoHS	Environmentally Friendly Use Period = 50 years
	For details about hazardous substances go to tab "Downloads", Category "Manufacturer's declaration"

Drawings

Feed-through header - ICV 2,5/ 8-GF-5,08 EX - 1810502

Drilling diagram

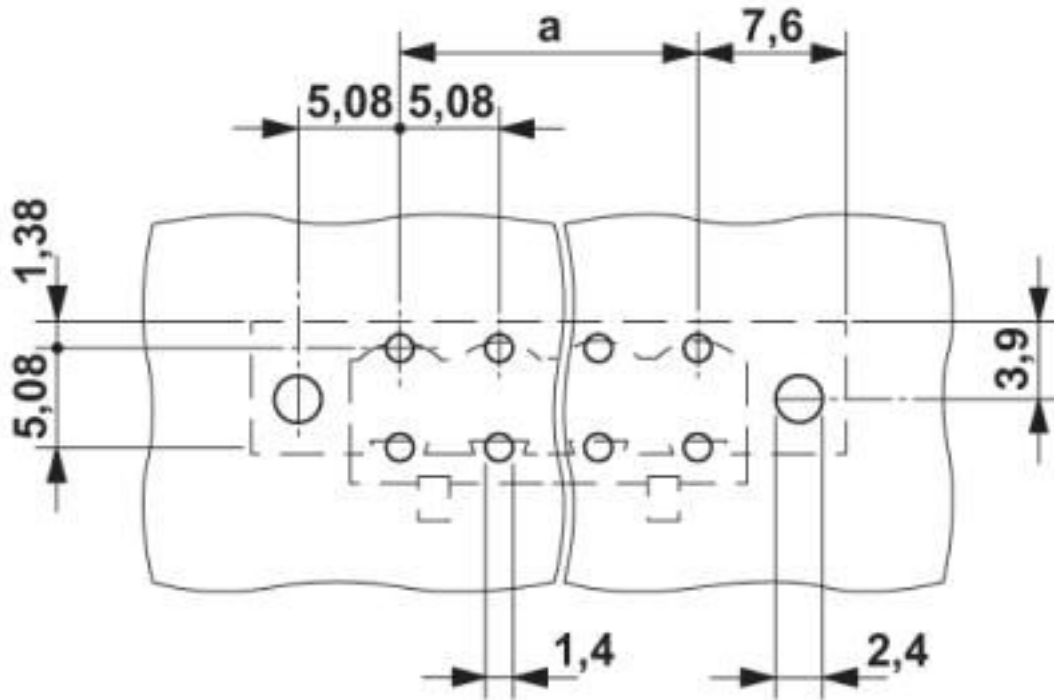

Dimensional drawing

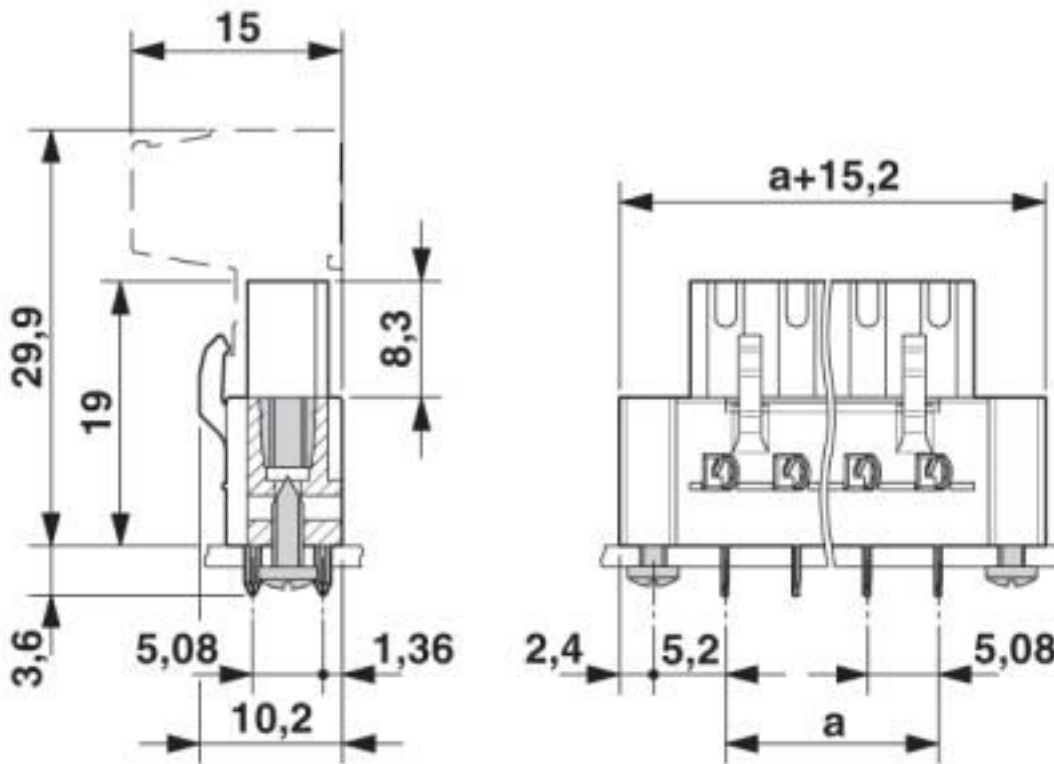

Feed-through header - ICV 2,5/ 8-GF-5,08 EX - 1810502

Classifications

eCl@ss

eCl@ss 10.0.1	27440402
eCl@ss 4.0	27260700
eCl@ss 4.1	27260700
eCl@ss 5.0	27260700
eCl@ss 5.1	27260700
eCl@ss 6.0	27260700
eCl@ss 7.0	27440402
eCl@ss 8.0	27440402
eCl@ss 9.0	27440402

ETIM

ETIM 3.0	EC001121
ETIM 4.0	EC002637
ETIM 5.0	EC002637
ETIM 6.0	EC002637
ETIM 7.0	EC002637

UNSPSC

UNSPSC 6.01	30211810
UNSPSC 7.0901	39121409
UNSPSC 11	39121409
UNSPSC 12.01	39121409
UNSPSC 13.2	39121409
UNSPSC 18.0	39121409
UNSPSC 19.0	39121409
UNSPSC 20.0	39121409
UNSPSC 21.0	39121409

Approvals

Approvals

Approvals

cULus Recognized

Ex Approvals

IECEX / ATEX / EAC Ex

Approval details

Feed-through header - ICV 2,5/ 8-GF-5,08 EX - 1810502

Approvals

cULus Recognized		http://database.ul.com/cgi-bin/XYV/template/LISEXT/1FRAME/index.htm	E60425-19931014
	B	D	
Nominal voltage UN	250 V	300 V	
Nominal current IN	12 A	10 A	

Accessories

Accessories

Coding element

Coding profile - CP-MSTB - 1734634

Coding profile, is inserted into the slot on the plug or inverted header, red insulating material



Test plug terminal block

Test plugs - MPS-MT - 0201744



Test plugs, with solder connection up to 1 mm² conductor cross section, color: gray

Reducing plug - RPS - 0201647



Reducing plug, color: gray

Phoenix Contact 2020 © - all rights reserved
<http://www.phoenixcontact.com>

PHOENIX CONTACT GmbH & Co. KG
Flachsmarktstr. 8
32825 Blomberg
Germany
Tel. +49 5235 300
Fax +49 5235 3 41200
<http://www.phoenixcontact.com>

Mouser Electronics

Authorized Distributor

Click to View Pricing, Inventory, Delivery & Lifecycle Information:

[Phoenix Contact:](#)

[1810502](#)