

Feed-through header - GMSTB 2,5/ 7-GF-7,62 - 1806274

Please be informed that the data shown in this PDF Document is generated from our Online Catalog. Please find the complete data in the user's documentation. Our General Terms of Use for Downloads are valid (<http://phoenixcontact.com/download>)

PCB headers, nominal current: 12 A, rated voltage (III/2): 630 V, nominal cross section: 2.5 mm², number of positions: 7, pitch: 7.62 mm, color: green, contact surface: Tin, mounting: Wave soldering, pin layout: Linear pinning, solder pin [P]: 3.2 mm



The figure shows a 10-position version of the product

Your advantages

- Plug-in direction parallel to the PCB
- Headers with angled solder pins for 630 V applications (III/2)
- Maximum flexibility when it comes to device design – one header for connectors with different connection technologies
- Well-known mounting principle allows worldwide use
- Larger pitch for increased voltage requirements



Key Commercial Data

| | |
|--------------|---------------|
| Packing unit | 50 pc |
| GTIN | |
| GTIN | 4017918046941 |

Technical data

Item properties

| | |
|---------------------------|---------------------|
| Brief article description | Feed-through header |
| Plug-in system | CLASSIC COMBICON |
| Type of contact | Male connector |
| Range of articles | GMSTB 2,5/..-GF |
| Pitch | 7.62 mm |
| Number of positions | 7 |
| Mounting type | Wave soldering |
| Pin layout | Linear pinning |
| Locking | Threaded flange |
| Number of levels | 1 |

Feed-through header - GMSTB 2,5/ 7-GF-7,62 - 1806274

Technical data

Item properties

| | |
|-----------------------|---|
| Number of connections | 7 |
| Number of potentials | 7 |

Electrical parameters

| | |
|-----------------------------|-------|
| Nominal current | 12 A |
| Nom. voltage | 630 V |
| Rated voltage | 400 V |
| Rated voltage (III/2) | 630 V |
| Rated voltage (II/2) | 630 V |
| Rated surge voltage (III/3) | 6 kV |
| Rated surge voltage (III/2) | 6 kV |
| Rated surge voltage (II/2) | 6 kV |

Material data - contact

| | |
|---|---|
| Note | WEEE/RoHS-compliant, free of whiskers according to IEC 60068-2-82/ JEDEC JESD 201 |
| Contact material | Cu alloy |
| Surface characteristics | Tin-plated |
| Metal surface contact area (top layer) | Tin (3 - 5 µm Sn) |
| Metal surface contact area (middle layer) | Nickel (1.3 - 3 µm Ni), |
| Metal surface soldering area (top layer) | Tin (3 - 5 µm Sn) |
| Metal surface soldering area (middle layer) | Nickel (1.3 - 3 µm Ni) |

Material data - housing

| | |
|---|--------------|
| Housing color | green (6021) |
| Insulating material | PA |
| Insulating material group | I |
| CTI according to IEC 60112 | 600 |
| Flammability rating according to UL 94 | V0 |
| Glow wire flammability index GWFI according to EN 60695-2-12 | 850 |
| Glow wire ignition temperature GWIT according to EN 60695-2-13 | 775 |
| Temperature for the ball pressure test according to EN 60695-10-2 | 125 °C |

Dimensions for the product

| | |
|-----------------------------|----------|
| Length [l] | 12 mm |
| Width [w] | 63.92 mm |
| Height [h] | 11.8 mm |
| Pitch | 7.62 mm |
| Height (without solder pin) | 8.6 mm |
| Solder pin [P] | 3.2 mm |
| Pin dimensions | 1 x 1 mm |

Dimensions for PCB design

| | |
|---------------|--------|
| Hole diameter | 1.4 mm |
|---------------|--------|

Feed-through header - GMSTB 2,5/ 7-GF-7,62 - 1806274

Technical data

Packaging information

| | |
|----------------------------|---------------------|
| Type of packaging | packed in cardboard |
| Pieces per package | 50 |
| Denomination packing units | Pcs. |

General product information

| | |
|------|--|
| Note | In accordance with IEC 61984, COMBICON connectors have no switching power (COC). During designated use, they must not be plugged in or disconnected when carrying voltage or under load. |
| | In accordance with IEC 61984, COMBICON connectors have no switching power (COC). During designated use, they must not be plugged in or disconnected when carrying voltage or under load. |

Air clearances and creepage distances

| | |
|---|---------------------|
| Clearances and creepage distances | IEC 60664-1:2007-04 |
| Specification | IEC 60664-1:2007-04 |
| Minimum clearance - inhomogeneous field (III/3) | 5.5 mm |
| Minimum clearance - inhomogeneous field (III/2) | 5.5 mm |
| Minimum clearance - inhomogeneous field (II/2) | 5.5 mm |
| Minimum creepage distance value (III/3) | 5 mm |
| Minimum creepage distance value (III/2) | 3.2 mm |
| Minimum creepage distance value (II/2) | 3.2 mm |

Mechanical tests (A)

| | |
|--|-------------|
| Test specification | IEC 61984 |
| Insertion strength per pos. approx. | 10 N |
| Withdraw strength per pos. approx. | 8 N |
| Polarization when inserted requirement >20 N | Test passed |
| Contact holder in insert requirements >20 N | Test passed |

Durability tests (B)

| | |
|--|-----------------------|
| Specification | IEC 60512-9-1:2010-03 |
| Contact resistance R ₁ | 2.2 mΩ |
| Insertion/withdrawal cycles | 25 |
| Contact resistance R ₂ | 2.2 mΩ |
| Impulse withstand voltage at sea level | 7.3 kV |
| Power-frequency withstand voltage | 3.31 kV |
| Insulation resistance, neighboring positions | > 24 GΩ |

Thermal tests (C)

| | |
|---|-----------------------|
| Specification | IEC 60512-5-1:2002-02 |
| Number of positions | 12 |
| Conductor cross section | 2.5 mm ² |
| Test current | 12 A |
| Upper limiting temperature requirements <100 °C | Test passed |

Feed-through header - GMSTB 2,5/ 7-GF-7,62 - 1806274

Technical data

Climatic tests (D)

| | |
|--|---|
| Specification | ISO 6988:1985-02 |
| Cold stress | -40 °C/2 h |
| Thermal stress | 105 °C/168 h |
| Corrosive stress | 0.2 dm ³ SO ₂ on 300 dm ³ /40 °C/1 cycle |
| Impulse withstand voltage at sea level | 7.3 kV |
| Power-frequency withstand voltage | 3.31 kV |

Environmental and durability tests (E)

| | |
|---------------------------------------|-------------------------------------|
| Specification | IEC 61984:2008-10 |
| Result, degree of protection, IP code | Finger safety with IP20 test finger |

Vibration test

| | |
|------------------------|------------------------|
| Specification | IEC 60068-2-6:2007-12 |
| Result | Test passed |
| Frequency | 10 - 150 - 10 Hz |
| Sweep speed | 1 octave/min |
| Amplitude | 0.35 mm (10 - 60.1 Hz) |
| Acceleration | 5 g (60.1 - 150 Hz) |
| Test duration per axis | 2.5 h |

Standards and Regulations

| | |
|--|--------|
| Connection in acc. with standard | EN-VDE |
| | CSA |
| Flammability rating according to UL 94 | V0 |

Environmental Product Compliance

| | |
|------------|---|
| REACH SVHC | Lead 7439-92-1 |
| China RoHS | Environmentally Friendly Use Period = 50 years |
| | For details about hazardous substances go to tab "Downloads", Category "Manufacturer's declaration" |

Drawings

Feed-through header - GMSTB 2,5/ 7-GF-7,62 - 1806274

Drilling diagram

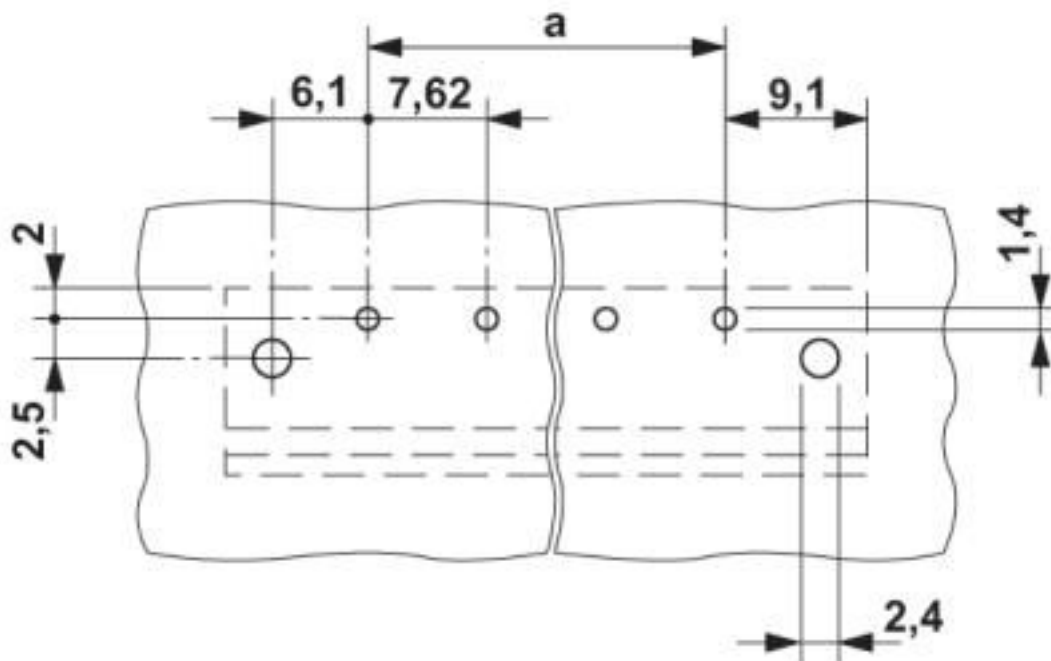

Diagram

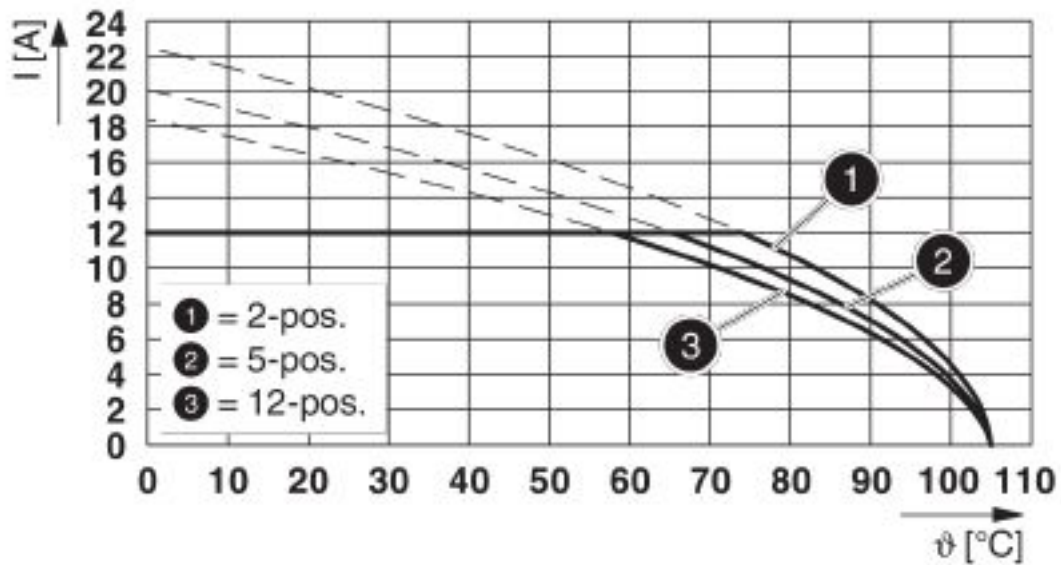

Type: GMVSTBR 2,5/...-STF-7,62 with GMSTB 2,5/...-GF-7,62

Feed-through header - GMSTB 2,5/ 7-GF-7,62 - 1806274

Diagram

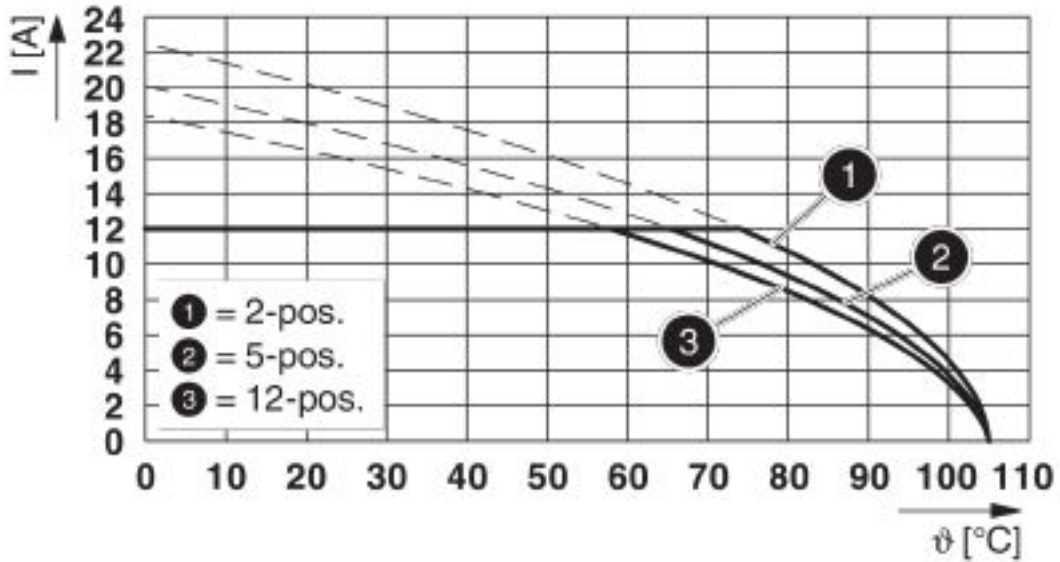

Type: GMVSTBW 2,5/...-STF-7,62 with GMSTB 2,5/...-GF-7,62

Diagram

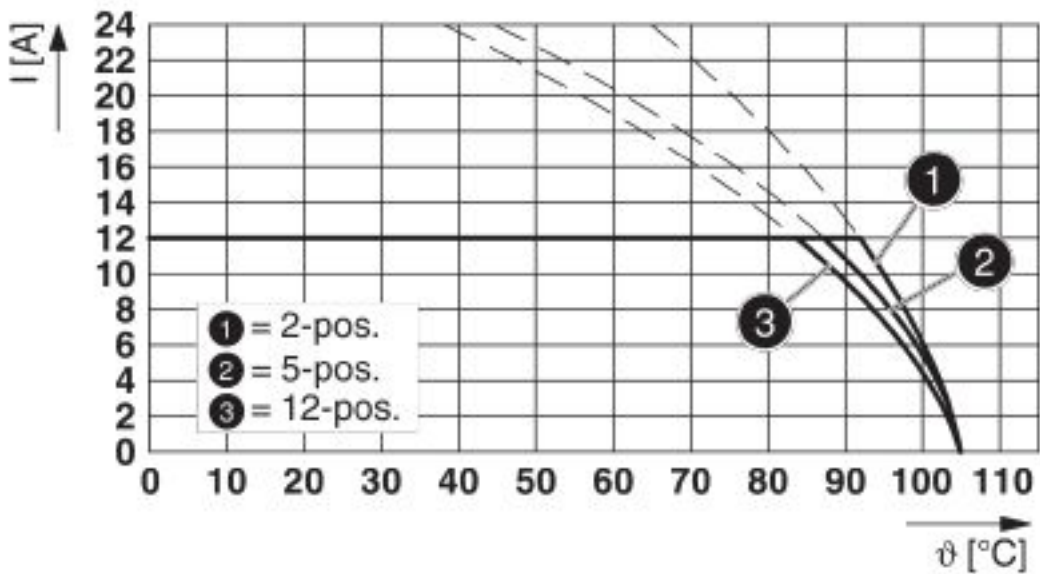

Type: GFKC 2,5/...-STF-7,62 with GMSTB 2,5/...-GF-7,62

Feed-through header - GMSTB 2,5/ 7-GF-7,62 - 1806274

Dimensional drawing

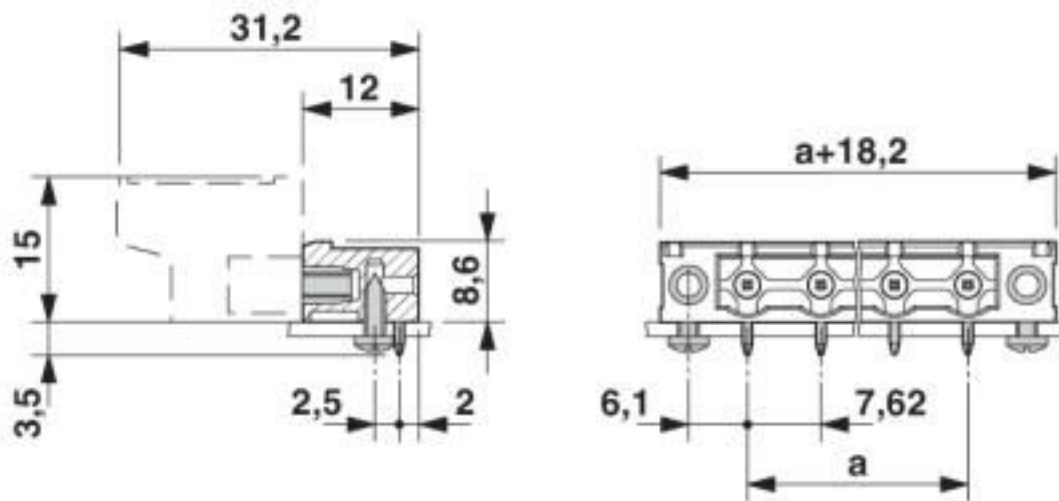

Classifications

eCl@ss

| | |
|---------------|----------|
| eCl@ss 10.0.1 | 27440402 |
| eCl@ss 4.0 | 27260700 |
| eCl@ss 4.1 | 27260700 |
| eCl@ss 5.0 | 27260700 |
| eCl@ss 5.1 | 27260700 |
| eCl@ss 6.0 | 27260700 |
| eCl@ss 7.0 | 27440402 |
| eCl@ss 8.0 | 27440402 |
| eCl@ss 9.0 | 27440402 |

ETIM

| | |
|----------|----------|
| ETIM 3.0 | EC001121 |
| ETIM 4.0 | EC002637 |
| ETIM 5.0 | EC002637 |
| ETIM 6.0 | EC002637 |
| ETIM 7.0 | EC002637 |

UNSPSC

| | |
|---------------|----------|
| UNSPSC 6.01 | 30211810 |
| UNSPSC 7.0901 | 39121409 |
| UNSPSC 11 | 39121409 |
| UNSPSC 12.01 | 39121409 |
| UNSPSC 13.2 | 39121409 |
| UNSPSC 18.0 | 39121409 |
| UNSPSC 19.0 | 39121409 |

Feed-through header - GMSTB 2,5/ 7-GF-7,62 - 1806274

Classifications

UNSPSC

| | |
|-------------|----------|
| UNSPSC 20.0 | 39121409 |
| UNSPSC 21.0 | 39121409 |

Approvals

Approvals

Approvals

CSA / IECCEB CB Scheme / EAC / cULus Recognized / VDE Zeichengenehmigung

Ex Approvals

Approval details

| | | | |
|--------------------|---|---|-----------------|
| CSA |  | http://www.csagroup.org/services-industries/product-listing/ | LR13631-2585950 |
| | B | D | |
| Nominal voltage UN | 300 V | 300 V | |
| Nominal current IN | 10 A | 10 A | |

| | | | |
|--------------------|---|---|----------------|
| IECEE CB Scheme |  | http://www.iecee.org/ | DE1-60988-B1B2 |
| Nominal voltage UN | 400 V | | |
| Nominal current IN | 12 A | | |

| | | |
|-----|---|---------|
| EAC |  | B.01687 |
|-----|---|---------|

| | | | |
|--------------------|---|---|-----------------|
| cULus Recognized |  | http://database.ul.com/cgi-bin/XYV/template/LISEXT/1FRAME/index.htm | E60425-19931013 |
| | B | D | |
| Nominal voltage UN | 300 V | 300 V | |
| Nominal current IN | 15 A | 10 A | |

Feed-through header - GMSTB 2,5/ 7-GF-7,62 - 1806274

Approvals

| | | | |
|------------------------|--|---|----------|
| VDE Zeichengenehmigung | | http://www2.vde.com/de/Institut/Online-Service/VDE-gepruefteProdukte/Seiten/Online-Suche.aspx | 40050648 |
| Nominal voltage UN | | 400 V | |
| Nominal current IN | | 12 A | |

Accessories

Accessories

Coding element

Coding section - CR-MSTB - 1734401

Coding section, inserted into the recess in the header or the inverted plug, red insulating material



Filler plug

Accessories - MSTB-BL - 1755477



Keying cap, for forming sections, plugs onto header pin, green insulating material

Labeled terminal marker

Marker card - SK 7,62/3,8:FORTL.ZAHLEN - 0804549

Marker card, Card, white, labeled, horizontal: consecutive numbers 1 ... 10, 11 ... 20, etc. up to 91 ... 100, mounting type: adhesive, for terminal block width: 7.62 mm, lettering field size: 7.62 x 3.8 mm



Additional products

Feed-through header - GMSTB 2,5/ 7-GF-7,62 - 1806274

Accessories

Printed-circuit board connector - FRONT-GMSTB 2,5/ 7-STF-7,62 - 1806054

PCB connector, nominal current: 12 A, rated voltage (III/2): 630 V, nominal cross section: 2.5 mm², number of positions: 7, pitch: 7.62 mm, connection method: Front screw connection, color: green, contact surface: Tin



Printed-circuit board connector - GMVSTBR 2,5/ 7-STF-7,62 - 1847932

PCB connector, nominal current: 12 A, rated voltage (III/2): 630 V, nominal cross section: 2.5 mm², number of positions: 7, pitch: 7.62 mm, connection method: Screw connection with tension sleeve, color: green, contact surface: Tin



Printed-circuit board connector - GMVSTBW 2,5/ 7-STF-7,62 - 1848041

PCB connector, nominal current: 12 A, rated voltage (III/2): 630 V, nominal cross section: 2.5 mm², number of positions: 7, pitch: 7.62 mm, connection method: Screw connection with tension sleeve, color: green, contact surface: Tin



Printed-circuit board connector - GMSTB 2,5/ 7-STF-7,62 - 1858811

PCB connector, nominal current: 12 A, rated voltage (III/2): 630 V, nominal cross section: 2.5 mm², number of positions: 7, pitch: 7.62 mm, connection method: Screw connection with tension sleeve, color: green, contact surface: Tin



Printed-circuit board connector - GFKC 2,5/ 7-STF-7,62 - 1939798

PCB connector, nominal current: 12 A, rated voltage (III/2): 630 V, nominal cross section: 2.5 mm², number of positions: 7, pitch: 7.62 mm, connection method: Push-in spring connection, color: green, contact surface: Tin, COMBICON connectors may only be activated under no load conditions. If for operating reasons small loads must be switched, experimental values are available upon request.



Phoenix Contact 2020 © - all rights reserved
<http://www.phoenixcontact.com>

PHOENIX CONTACT GmbH & Co. KG
Flachmarktstr. 8
32825 Blomberg
Germany
Tel. +49 5235 300
Fax +49 5235 3 41200
<http://www.phoenixcontact.com>

Mouser Electronics

Authorized Distributor

Click to View Pricing, Inventory, Delivery & Lifecycle Information:

[Phoenix Contact:](#)

[1806274](#)