

Printed-circuit board connector - MCV 1,5/ 6-G-3,5 P26 THRR56 - 1779459

Please be informed that the data shown in this PDF Document is generated from our Online Catalog. Please find the complete data in the user's documentation. Our General Terms of Use for Downloads are valid (<http://phoenixcontact.com/download>)

PCB headers, nominal current: 8 A, rated voltage (III/2): 160 V, nominal cross section: 1.5 mm², number of positions: 6, pitch: 3.5 mm, color: black, contact surface: Tin, mounting: THR soldering, pin layout: Linear pinning, solder pin [P]: 2.6 mm, User information and design recommendations for through hole reflow technology can be found under: Downloads



Your advantages

- Designed for integration into the SMT soldering process
- Vertical connection enables multi-row arrangement on the PCB
- Maximum flexibility when it comes to device design – one header for connectors with different connection technologies



Key Commercial Data

Packing unit	200 pc
Minimum order quantity	200 pc
GTIN	
GTIN	4046356531894

Technical data

Item properties

Brief article description	Feed-through header
Plug-in system	MINI COMBICON
Type of contact	Male connector
Range of articles	MCV 1,5/...-G-THR
Pitch	3.5 mm
Number of positions	6
Mounting type	THR soldering
Pin layout	Linear pinning
Locking	without
Number of levels	1
Number of connections	6

Printed-circuit board connector - MCV 1,5/ 6-G-3,5 P26 THRR56 - 1779459

Technical data

Item properties

Number of potentials	6
----------------------	---

Electrical parameters

Nominal current	8 A
Nom. voltage	160 V
Rated voltage	160 V
Rated voltage (III/2)	160 V
Rated voltage (II/2)	250 V
Rated surge voltage (III/3)	2.5 kV
Rated surge voltage (III/2)	2.5 kV
Rated surge voltage (II/2)	2.5 kV

Material data - contact

Note	WEEE/RoHS-compliant, free of whiskers according to IEC 60068-2-82/ JEDEC JESD 201
Contact material	Cu alloy
Surface characteristics	Tin-plated
Metal surface contact area (top layer)	Tin (3 - 5 µm Sn)
Metal surface contact area (middle layer)	Nickel (1.3 - 3 µm Ni),
Metal surface soldering area (top layer)	Tin (3 - 5 µm Sn)
Metal surface soldering area (middle layer)	Nickel (1.3 - 3 µm Ni)

Material data - housing

Housing color	black (9005)
Insulating material	LCP
Insulating material group	IIIa
CTI according to IEC 60112	175
Flammability rating according to UL 94	V0

Dimensions for the product

Length [l]	6.9 mm
Width [w]	22.4 mm
Height [h]	11.8 mm
Pitch	3.5 mm
Height (without solder pin)	9.2 mm
Solder pin [P]	2.6 mm
Pin dimensions	0.8 x 0.8 mm

Dimensions for PCB design

Hole diameter	1.4 mm
---------------	--------

Packaging information

Type of packaging	56 mm wide tape
-------------------	-----------------

Printed-circuit board connector - MCV 1,5/ 6-G-3,5 P26 THRR56 - 1779459

Technical data

Packaging information

Pieces per package	200
Denomination packing units	Pcs.
[W] tape width	56 mm
[A] coil diameter	330 mm
[W2] coil overall dimension	62.4 mm
Outer packaging type	Transparent-Bag

Processing notes

Process	Reflow/wave soldering
Specification	Following IPC/JEDEC J-STD-020E:2014-12
	Following IEC 61760-1:2006-04
	Following IEC 60068-2-58:2015-03
Moisture Sensitive Level	MSL 1
Classification temperature T _c	260 °C
Solder cycles in the reflow	3

Ambient conditions

Ambient temperature (storage/transport)	-40 °C ... 70 °C
Ambient temperature (assembly)	-5 °C ... 100 °C
Ambient temperature (operation)	-40 °C ... 100 °C (dependent on the derating curve)

Air clearances and creepage distances

Clearances and creepage distances	IEC 60664-1:2007-04
Specification	IEC 60664-1:2007-04
Minimum clearance - inhomogeneous field (III/3)	1.5 mm
Minimum clearance - inhomogeneous field (III/2)	1.5 mm
Minimum clearance - inhomogeneous field (II/2)	1.5 mm
Minimum creepage distance value (III/3)	2.5 mm
Minimum creepage distance value (III/2)	1.6 mm
Minimum creepage distance value (II/2)	2.5 mm

Mechanical tests (A)

Test specification	IEC 61984
Insertion strength per pos. approx.	9 N
Withdraw strength per pos. approx.	7 N
Polarization when inserted requirement >20 N	Test passed
Contact holder in insert requirements >20 N	Test passed

Durability tests (B)

Specification	IEC 60512-9-1:2010-03
Contact resistance R ₁	1.6 mΩ
Insertion/withdrawal cycles	25

Printed-circuit board connector - MCV 1,5/ 6-G-3,5 P26 THRR56 - 1779459

Technical data

Durability tests (B)

Contact resistance R ₂	1.7 mΩ
Impulse withstand voltage at sea level	2.95 kV
Power-frequency withstand voltage	1.39 kV
Insulation resistance, neighboring positions	> 22 TΩ

Thermal tests (C)

Specification	IEC 60512-5-1:2002-02
Number of positions	20
Conductor cross section	1.5 mm ²
Test current	8 A
Upper limiting temperature requirements <100 °C	Test passed

Climatic tests (D)

Specification	ISO 6988:1985-02
Cold stress	-40 °C/2 h
Thermal stress	100 °C/168 h
Corrosive stress	0.2 dm ³ SO ₂ on 300 dm ³ /40 °C/1 cycle
Impulse withstand voltage at sea level	2.95 kV
Power-frequency withstand voltage	1.39 kV

Environmental and durability tests (E)

Specification	IEC 61984:2008-10
Result, degree of protection, IP code	Finger safety with IP20 test finger

Vibration test

Specification	IEC 60068-2-6:2007-12
Result	Test passed
Frequency	10 - 150 - 10 Hz
Sweep speed	1 octave/min
Amplitude	0.35 mm (10 - 60.1 Hz)
Acceleration	5 g (60.1 - 150 Hz)
Test duration per axis	2.5 h

Standards and Regulations

Connection in acc. with standard	EN-VDE
Flammability rating according to UL 94	V0

Environmental Product Compliance

China RoHS	Environmentally friendly use period: unlimited = EFUP-e
	No hazardous substances above threshold values

Drawings

Printed-circuit board connector - MCV 1,5/ 6-G-3,5 P26 THR56 - 1779459

Drilling diagram

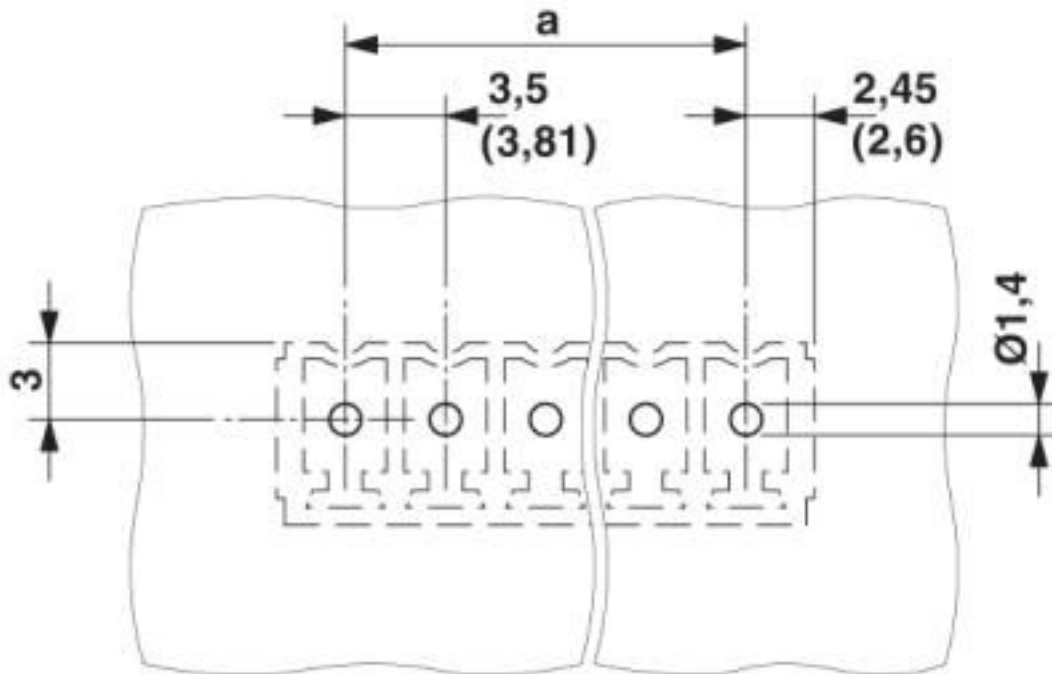

Diagram

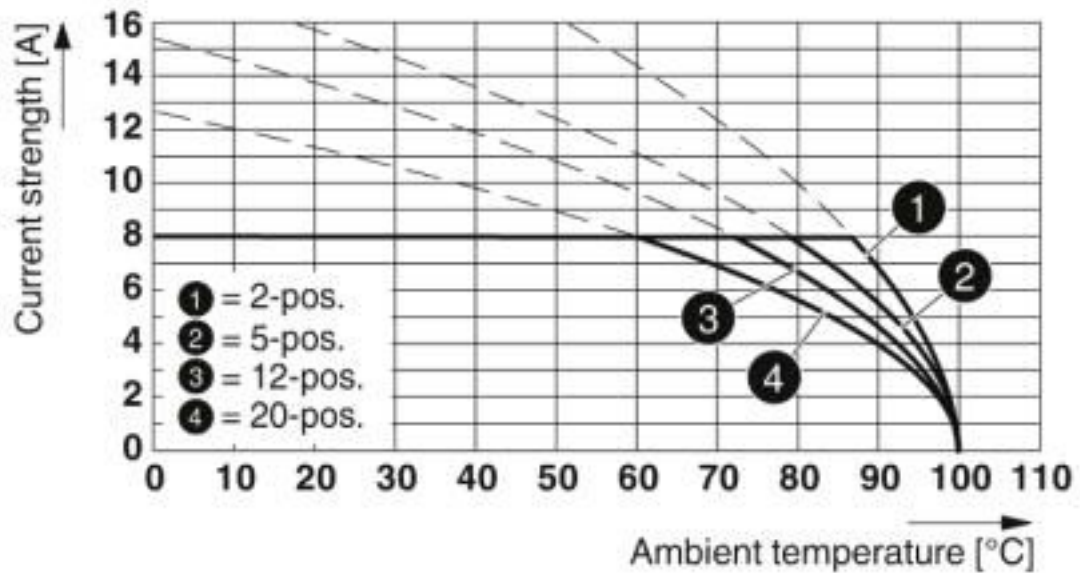

Type: FMC 1,5/...-ST-3,5 with MCV 1,5/...-G-3,5 P... THR

Printed-circuit board connector - MCV 1,5/ 6-G-3,5 P26 THRR56 - 1779459

Diagram

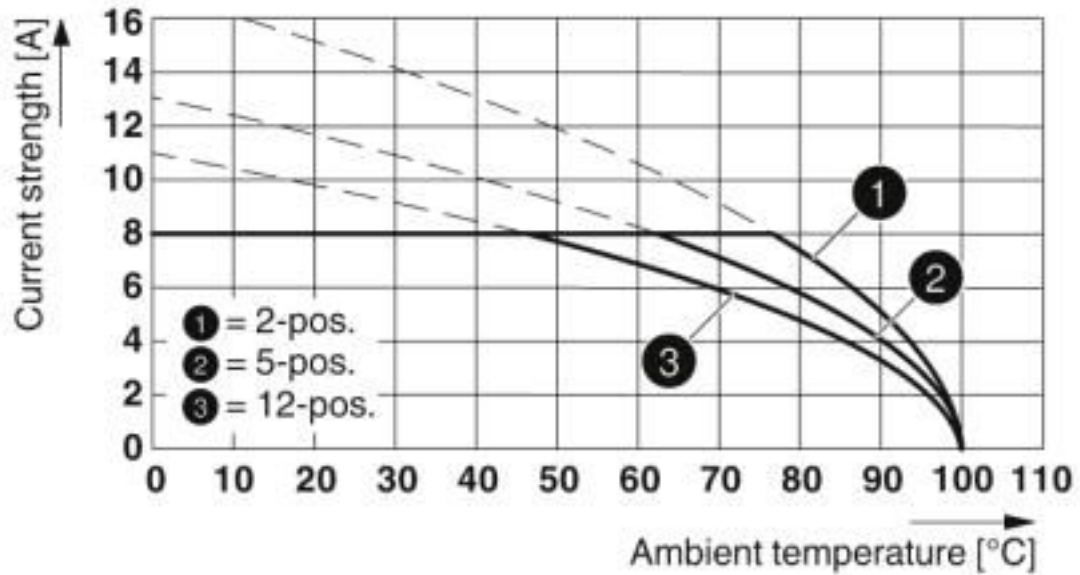

Type: MCVR 1,5/...-ST-3,5 with MCV 1,5/...-G-3,5 P26THR

Diagram

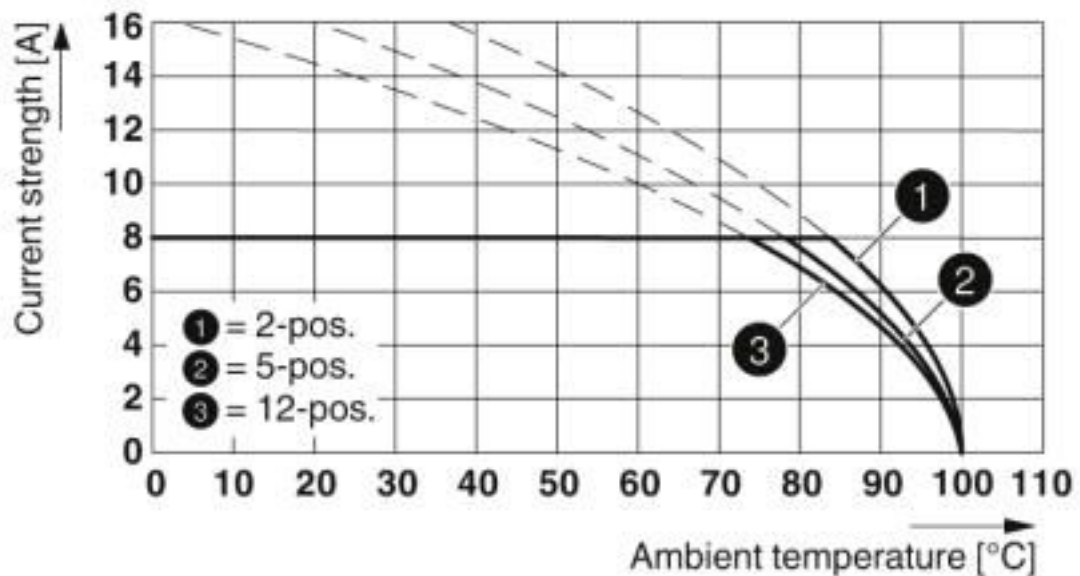

Type: FK-MCP 1,5/...-ST-3,5 with MCV 1,5/...-G-3,5 P... THR

Printed-circuit board connector - MCV 1,5/ 6-G-3,5 P26 THRR56 - 1779459

Diagram

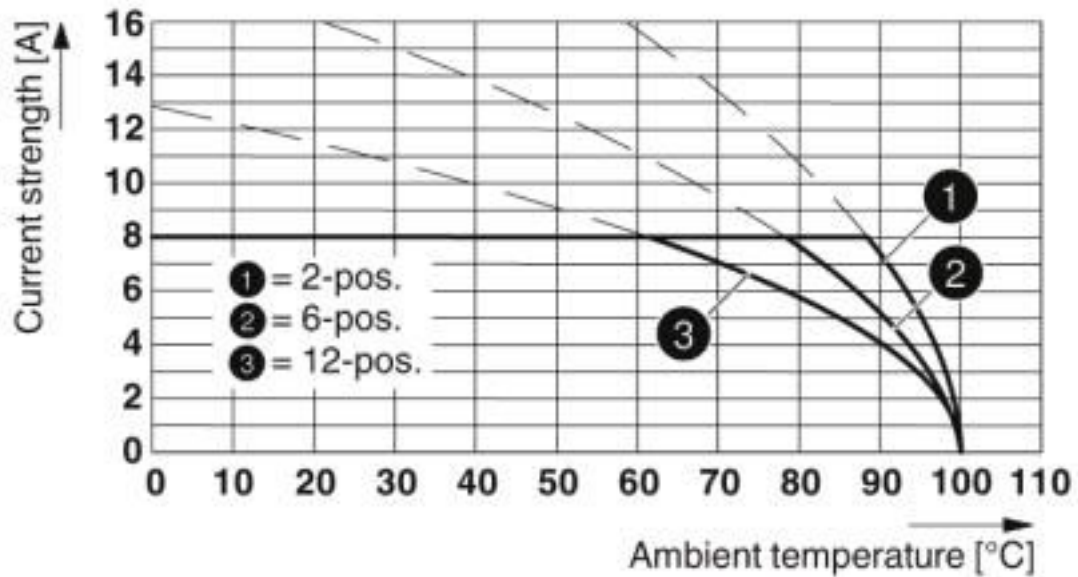

Type: IMCV 1,5/...-G-3,5 P20 THR with MCV 1,5/...-G-3,5 P26 THR

Dimensional drawing

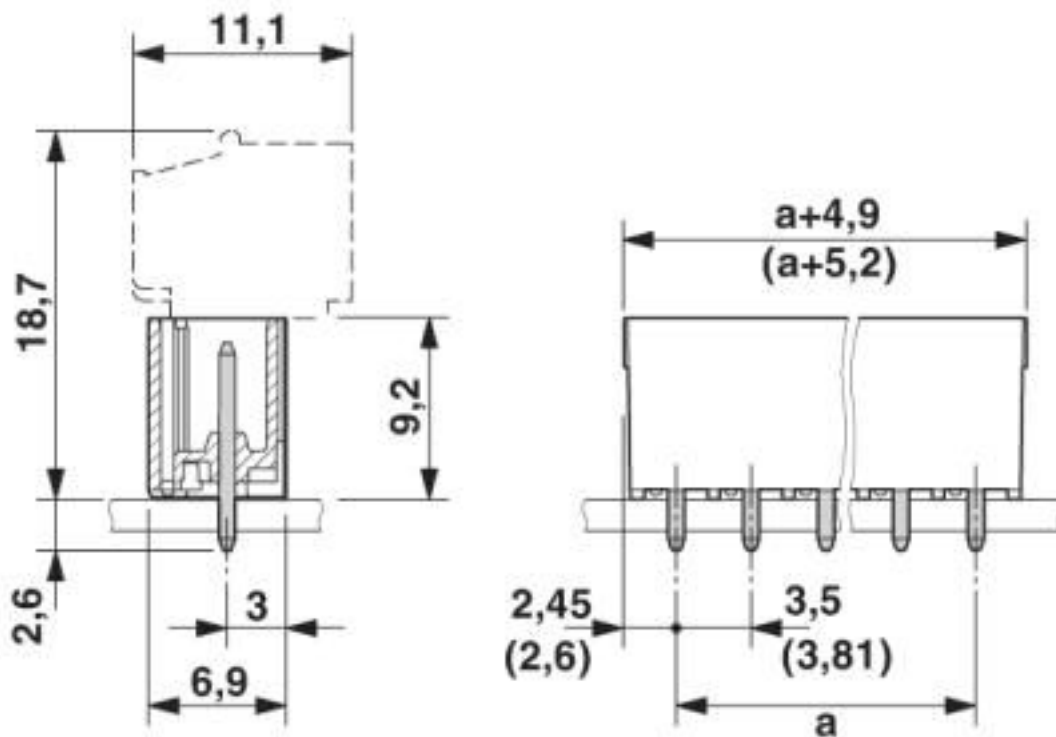

Printed-circuit board connector - MCV 1,5/ 6-G-3,5 P26 THRR56 - 1779459

Classifications

eCl@ss

eCl@ss 10.0.1	27440402
eCl@ss 4.0	27260700
eCl@ss 4.1	27260700
eCl@ss 5.0	27260700
eCl@ss 5.1	27260700
eCl@ss 6.0	27260700
eCl@ss 7.0	27440402
eCl@ss 8.0	27440402
eCl@ss 9.0	27440402

ETIM

ETIM 4.0	EC002637
ETIM 5.0	EC002637
ETIM 6.0	EC002637
ETIM 7.0	EC002637

UNSPSC

UNSPSC 6.01	30211810
UNSPSC 7.0901	39121409
UNSPSC 11	39121409
UNSPSC 12.01	39121409
UNSPSC 13.2	39121409
UNSPSC 18.0	39121409
UNSPSC 19.0	39121409
UNSPSC 20.0	39121409
UNSPSC 21.0	39121409

Approvals

Approvals

Approvals

IECEE CB Scheme / VDE Gutachten mit Fertigungsüberwachung / EAC / cULus Recognized

Ex Approvals

Approval details

Printed-circuit board connector - MCV 1,5/ 6-G-3,5 P26 THRR56 - 1779459

Approvals

IECEE CB Scheme		http://www.iecee.org/	DE1-60987-B1B2
Nominal voltage UN		160 V	
Nominal current IN		8 A	

VDE Gutachten mit Fertigungsüberwachung		http://www2.vde.com/de/Institut/Online-Service/ VDE-gepruefteProdukte/Seiten/Online-Suche.aspx	40011723
Nominal voltage UN		160 V	
Nominal current IN		8 A	

EAC		B.01687
-----	---	---------

cULus Recognized		http://database.ul.com/cgi-bin/XYV/template/LISEXT/1FRAME/index.htm	E60425-20110128
Nominal voltage UN		B 300 V	D 300 V
Nominal current IN		8 A	8 A

Phoenix Contact 2020 © - all rights reserved
<http://www.phoenixcontact.com>

PHOENIX CONTACT GmbH & Co. KG
Flachsmarktstr. 8
32825 Blomberg
Germany
Tel. +49 5235 300
Fax +49 5235 3 41200
<http://www.phoenixcontact.com>

Mouser Electronics

Authorized Distributor

Click to View Pricing, Inventory, Delivery & Lifecycle Information:

[Phoenix Contact:](#)

[1779459](#)