

# Feed-through header - MSTB 2,5/12-G-5,08 - 1759114

Please be informed that the data shown in this PDF Document is generated from our Online Catalog. Please find the complete data in the user's documentation. Our General Terms of Use for Downloads are valid (<http://phoenixcontact.com/download>)

PCB headers, nominal current: 12 A, rated voltage (III/2): 320 V, nominal cross section: 2.5 mm<sup>2</sup>, number of positions: 12, pitch: 5.08 mm, color: green, contact surface: Tin, mounting: Wave soldering, pin layout: Linear pinning, solder pin [P]: 3.5 mm



The figure shows a 10-position version of the product

## Your advantages

- ✓ Maximum flexibility when it comes to device design – one header for connectors with different connection technologies
- ✓ Easy PCB replacement thanks to plug-in modules
- ✓ Well-known mounting principle allows worldwide use
- ✓ Plug-in direction parallel to the PCB
- ✓ Items that can be aligned in various pitches support flexible and space-saving PCB assembly



## Key Commercial Data

|              |   |
|--------------|---|
| Packing unit | 50 pc   |
| GTIN         | <br>4 017918 030582 |
| GTIN         | 4017918030582   |

## Technical data

### Item properties

|                           |                     |
|---------------------------|---------------------|
| Brief article description | Feed-through header |
| Plug-in system            | CLASSIC COMBICON    |
| Type of contact           | Male connector      |
| Range of articles         | MSTB 2,5/..-G       |
| Pitch                     | 5.08 mm             |
| Number of positions       | 12                  |
| Mounting type             | Wave soldering      |
| Pin layout                | Linear pinning      |
| Locking                   | without             |
| Number of levels          | 1                   |

# Feed-through header - MSTB 2,5/12-G-5,08 - 1759114

## Technical data

### Item properties

|                       |    |
|-----------------------|----|
| Number of connections | 12 |
| Number of potentials  | 12 |

### Electrical parameters

|                             |       |
|-----------------------------|-------|
| Nominal current             | 12 A  |
| Nom. voltage                | 320 V |
| Rated voltage               | 320 V |
| Rated voltage (III/2)       | 320 V |
| Rated voltage (II/2)        | 630 V |
| Rated surge voltage (III/3) | 4 kV  |
| Rated surge voltage (III/2) | 4 kV  |
| Rated surge voltage (II/2)  | 4 kV  |

### Material data - contact

|   |   |
|---|---|
| Note  | WEEE/RoHS-compliant, free of whiskers according to IEC 60068-2-82/ JEDEC JESD 201 |
| Contact material                            | Cu alloy  |
| Surface characteristics                     | Tin-plated  |
| Metal surface contact area (top layer)      | Tin (3 - 5 µm Sn)   |
| Metal surface contact area (middle layer)   | Nickel (1.3 - 3 µm Ni),   |
| Metal surface soldering area (top layer)    | Tin (3 - 5 µm Sn)   |
| Metal surface soldering area (middle layer) | Nickel (1.3 - 3 µm Ni)  |

### Material data - housing

|   |              |
|---|--------------|
| Housing color   | green (6021) |
| Insulating material   | PA           |
| Insulating material group   | I            |
| CTI according to IEC 60112  | 600          |
| Flammability rating according to UL 94                            | V0           |
| Glow wire flammability index GWFI according to EN 60695-2-12      | 850          |
| Glow wire ignition temperature GWIT according to EN 60695-2-13    | 775          |
| Temperature for the ball pressure test according to EN 60695-10-2 | 125 °C       |

### Dimensions for the product

|                             |          |
|-----------------------------|----------|
| Length [ l ]                | 12 mm    |
| Width [ w ]                 | 60.96 mm |
| Height [ h ]                | 12.1 mm  |
| Pitch                       | 5.08 mm  |
| Height (without solder pin) | 8.6 mm   |
| Solder pin [P]              | 3.5 mm   |
| Pin dimensions              | 1 x 1 mm |

### Dimensions for PCB design

|               |        |
|---------------|--------|
| Hole diameter | 1.4 mm |
|---------------|--------|

# Feed-through header - MSTB 2,5/12-G-5,08 - 1759114

## Technical data

### Packaging information

|                            |                     |
|----------------------------|---------------------|
| Type of packaging          | packed in cardboard |
| Pieces per package         | 50                  |
| Denomination packing units | Pcs.                |

### Ambient conditions

|   |   |
|---|---|
| Ambient temperature (storage/transport) | -40 °C ... 70 °C                                    |
| Ambient temperature (assembly)          | -5 °C ... 100 °C                                    |
| Ambient temperature (operation)         | -40 °C ... 100 °C (dependent on the derating curve) |

### Air clearances and creepage distances

|   |                     |
|---|---------------------|
| Clearances and creepage distances               | IEC 60664-1:2007-04 |
| Specification                                   | IEC 60664-1:2007-04 |
| Minimum clearance - inhomogeneous field (III/3) | 3 mm                |
| Minimum clearance - inhomogeneous field (III/2) | 3 mm                |
| Minimum clearance - inhomogeneous field (II/2)  | 3 mm                |
| Minimum creepage distance value (III/3)         | 4 mm                |
| Minimum creepage distance value (III/2)         | 3 mm                |
| Minimum creepage distance value (II/2)          | 3.2 mm              |

### Mechanical tests (A)

|  |             |
|--|-------------|
| Test specification                           | IEC 61984   |
| Insertion strength per pos. approx.          | 8 N         |
| Withdraw strength per pos. approx.           | 6 N         |
| Polarization when inserted requirement >20 N | Test passed |
| Contact holder in insert requirements >20 N  | Test passed |

### Durability tests (B)

|  |                       |
|--|-----------------------|
| Specification                                | IEC 60512-9-1:2010-03 |
| Contact resistance R <sub>1</sub>            | 1.4 mΩ                |
| Insertion/withdrawal cycles                  | 25                    |
| Contact resistance R <sub>2</sub>            | 1.4 mΩ                |
| Impulse withstand voltage at sea level       | 4.8 kV                |
| Power-frequency withstand voltage            | 2.21 kV               |
| Insulation resistance, neighboring positions | > 0.3 TΩ              |

### Thermal tests (C)

|   |                       |
|---|-----------------------|
| Specification                                   | IEC 60512-5-1:2002-02 |
| Number of positions                             | 24                    |
| Conductor cross section                         | 2.5 mm <sup>2</sup>   |
| Test current                                    | 12 A                  |
| Upper limiting temperature requirements <100 °C | Test passed           |

### Climatic tests (D)

|               |                  |
|---------------|------------------|
| Specification | ISO 6988:1985-02 |
|---------------|------------------|

## Feed-through header - MSTB 2,5/12-G-5,08 - 1759114

### Technical data

#### Climatic tests (D)

|  |   |
|--|---|
| Cold stress                            | -40 °C/2 h  |
| Thermal stress                         | 100 °C/168 h  |
| Corrosive stress                       | 0.2 dm <sup>3</sup> SO <sub>2</sub> on 300 dm <sup>3</sup> /40 °C/1 cycle |
| Impulse withstand voltage at sea level | 4.8 kV  |
| Power-frequency withstand voltage      | 2.21 kV   |

#### Environmental and durability tests (E)

|                                       |                                     |
|---------------------------------------|-------------------------------------|
| Specification                         | IEC 61984:2008-10                   |
| Result, degree of protection, IP code | Finger safety with IP20 test finger |

#### Vibration test

|                        |                        |
|------------------------|------------------------|
| Specification          | IEC 60068-2-6:2007-12  |
| Result                 | Test passed            |
| Frequency              | 10 - 150 - 10 Hz       |
| Sweep speed            | 1 octave/min           |
| Amplitude              | 0.35 mm (10 - 60.1 Hz) |
| Acceleration           | 5 g (60.1 - 150 Hz)    |
| Test duration per axis | 2.5 h                  |

#### Standards and Regulations

|  |        |
|--|--------|
| Connection in acc. with standard       | EN-VDE |
|  | CSA    |
| Flammability rating according to UL 94 | V0     |

#### Environmental Product Compliance

|            |   |
|------------|---|
| China RoHS | Environmentally friendly use period: unlimited = EFUP-e |
|            | No hazardous substances above threshold values          |

### Drawings

# Feed-through header - MSTB 2,5/12-G-5,08 - 1759114

Diagram

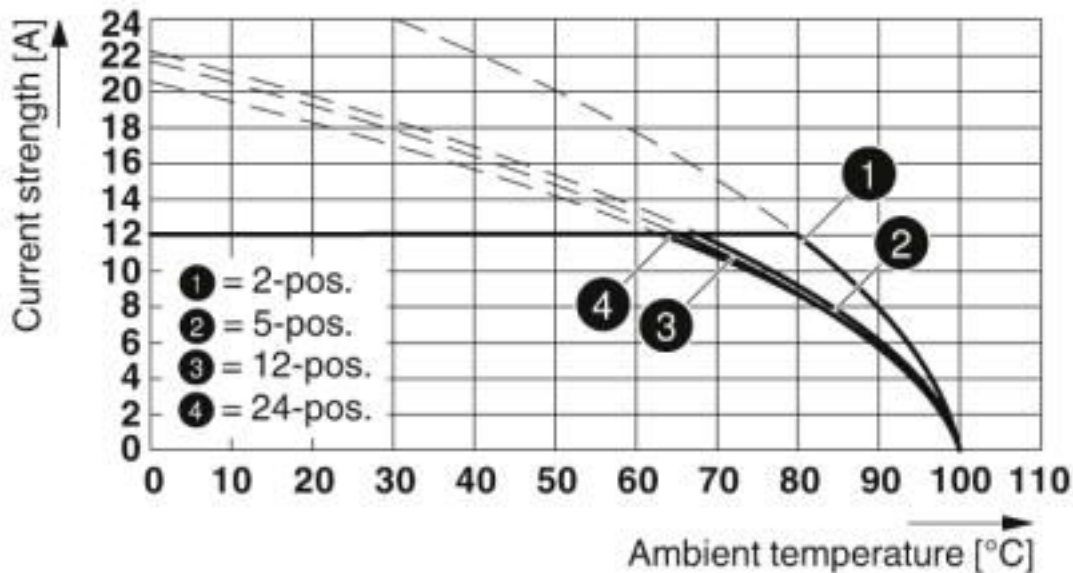

Type: MSTB 2,5/...-ST-5,08 with MSTB 2,5/...-G-5,08

Diagram

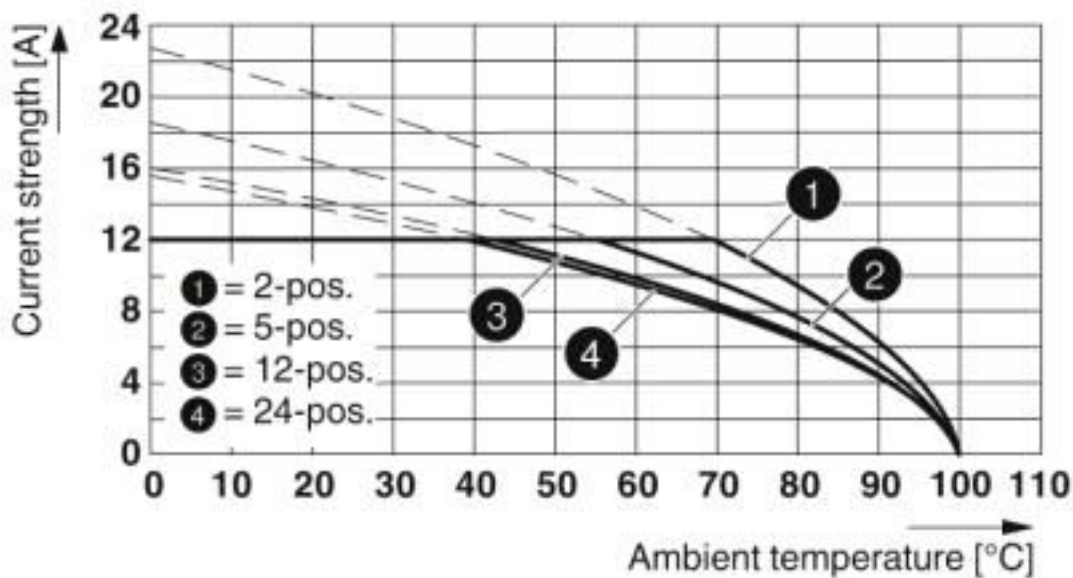

Type: MSTBU 2,5/...-STD-5,08 with MSTB 2,5/...-G-5,08

# Feed-through header - MSTB 2,5/12-G-5,08 - 1759114

Diagram

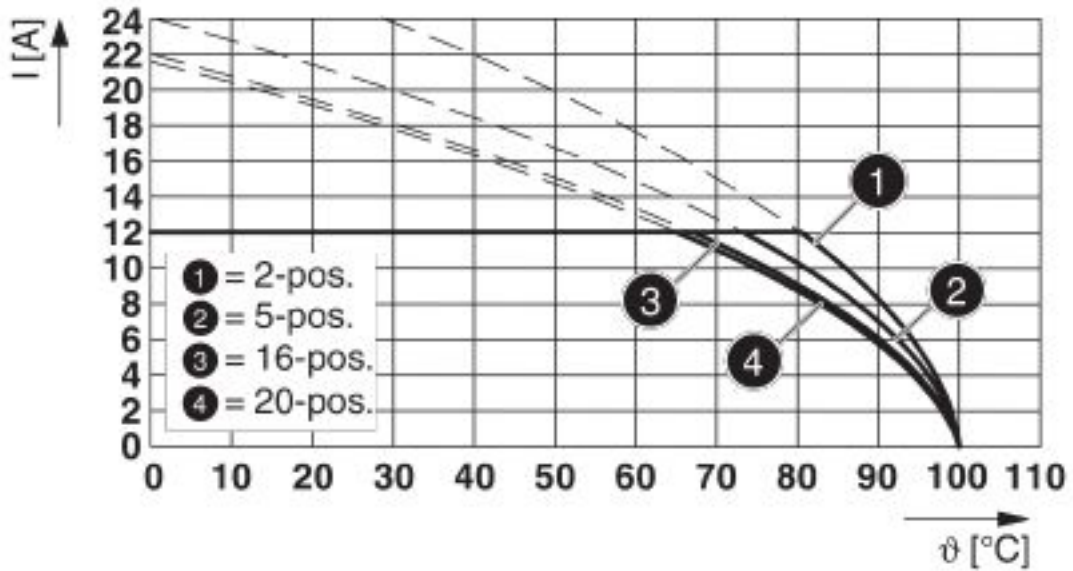

Type: FKCT 2,5/...-ST-5,08 with MSTB 2,5/...-G-5,08

Diagram

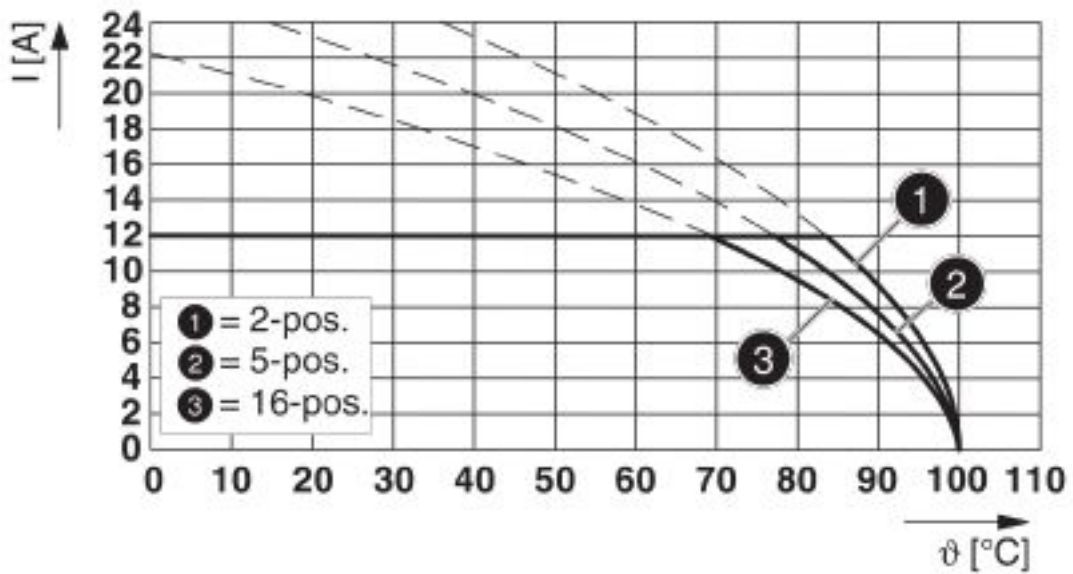

Type: FKCV(W/R) 2,5/...-ST-5,08 with MSTB 2,5/...-G-5,08

# Feed-through header - MSTB 2,5/12-G-5,08 - 1759114

Diagram

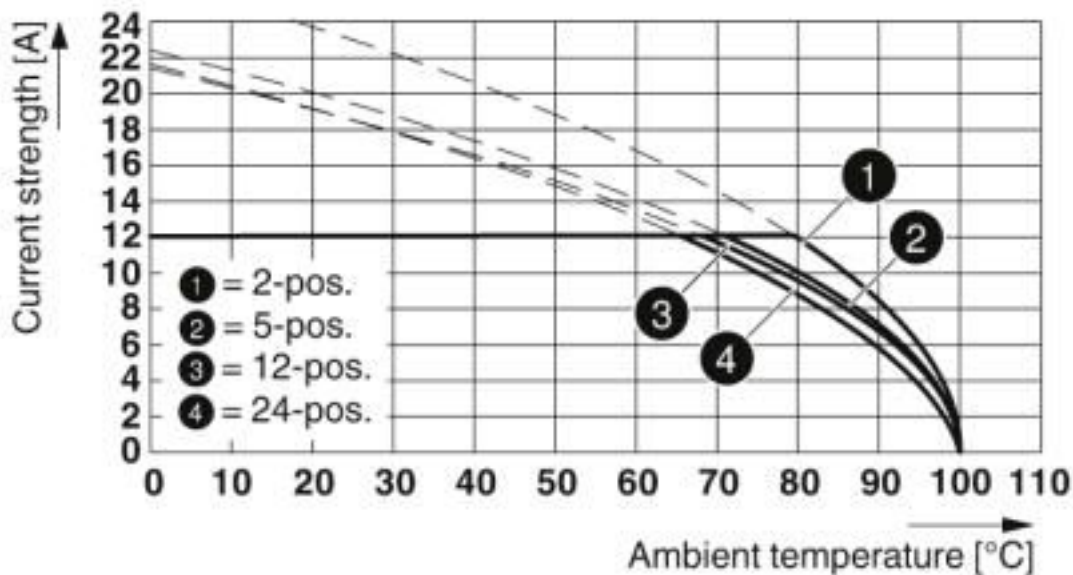

Type: MSTBP 2,5/...-ST-5,08 with MSTB 2,5/...-G-5,08

Diagram

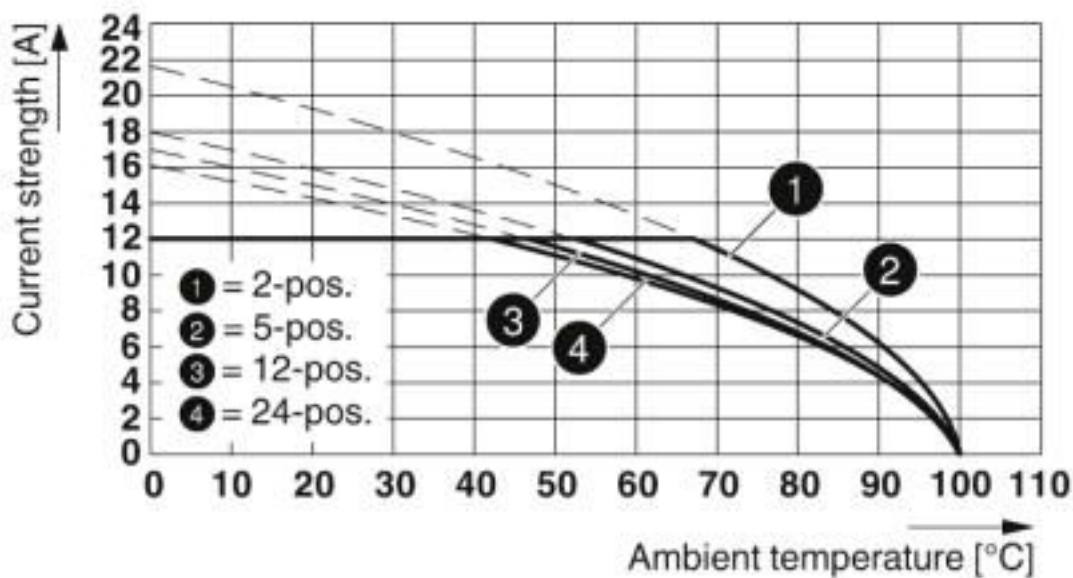

Type: SMSTB 2,5/...-ST-5,08 with MSTB 2,5/...-G-5,08

# Feed-through header - MSTB 2,5/12-G-5,08 - 1759114

Diagram

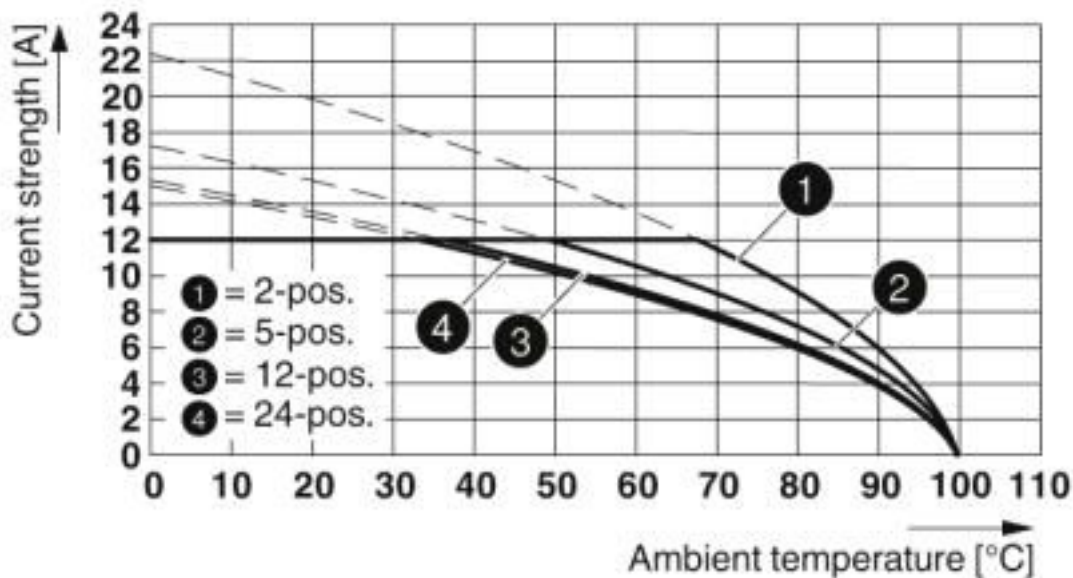

Type: MVSTB(R/W) 2,5/...-ST with MDSTBVA 2,5/...-G-5,08

Diagram

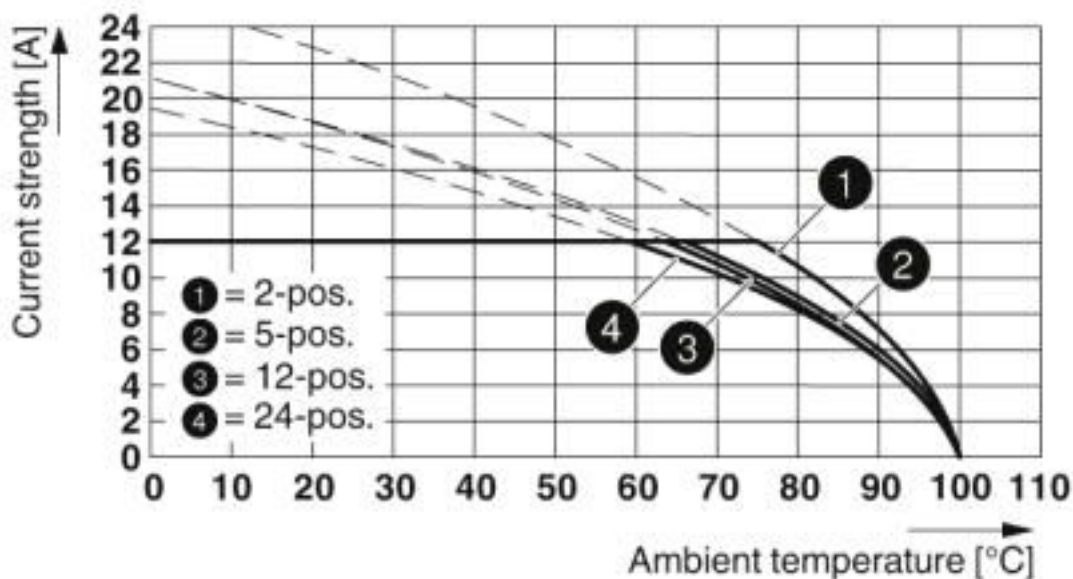

Type: FRONT-MSTB 2,5/...-ST-5,08 with MSTB 2,5/...-G-5,08



# Feed-through header - MSTB 2,5/12-G-5,08 - 1759114

Diagram

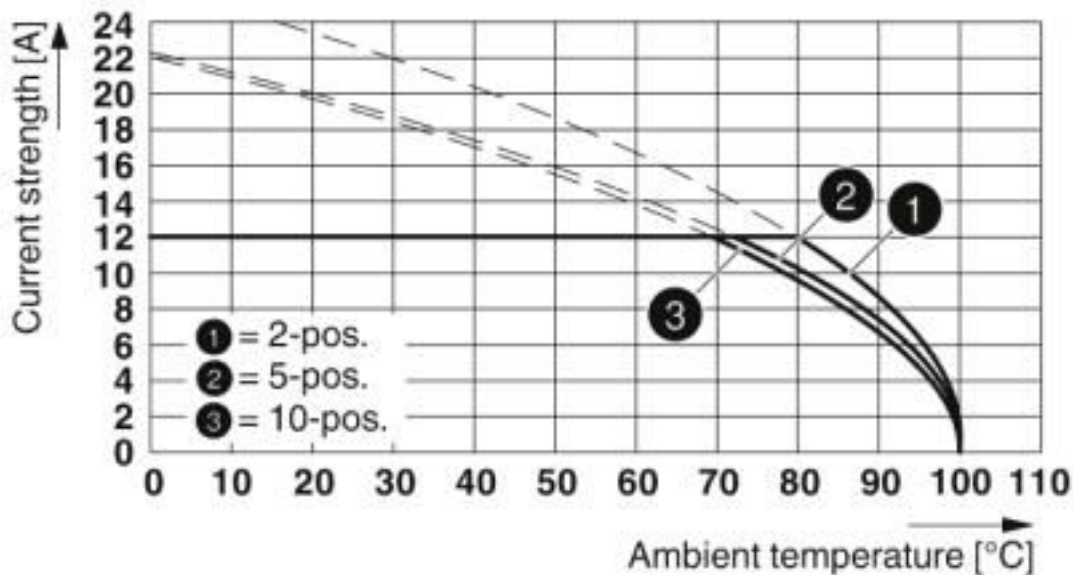

Type: TMSTBP 2,5/...-ST-5,08 with MSTB 2,5/...-G-5,08

Diagram

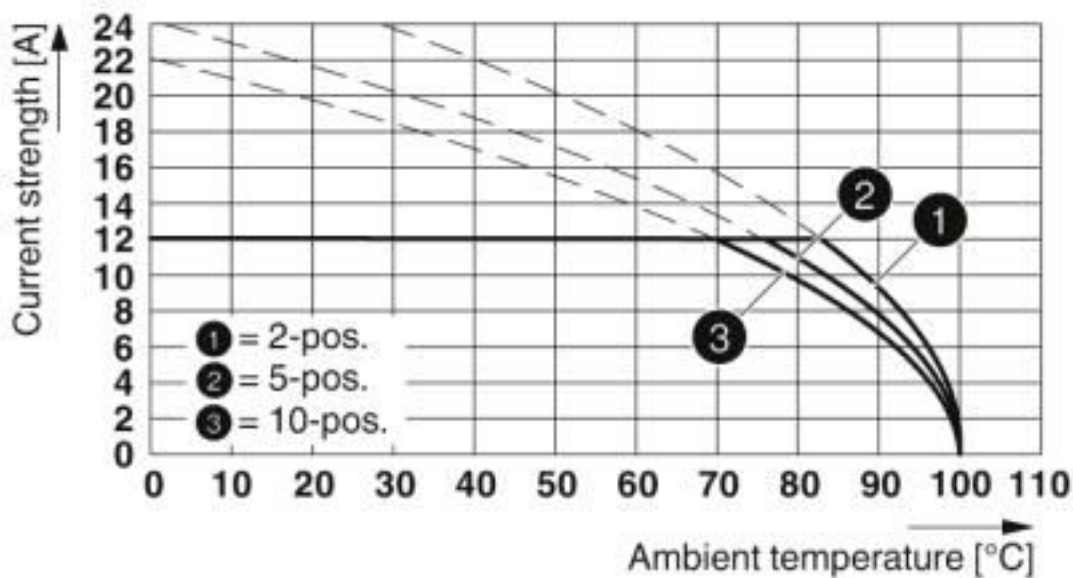

Type: TVMSTB 2,5/...-ST-5,08 with MSTB 2,5/...-G-5,08

# Feed-through header - MSTB 2,5/12-G-5,08 - 1759114

Diagram

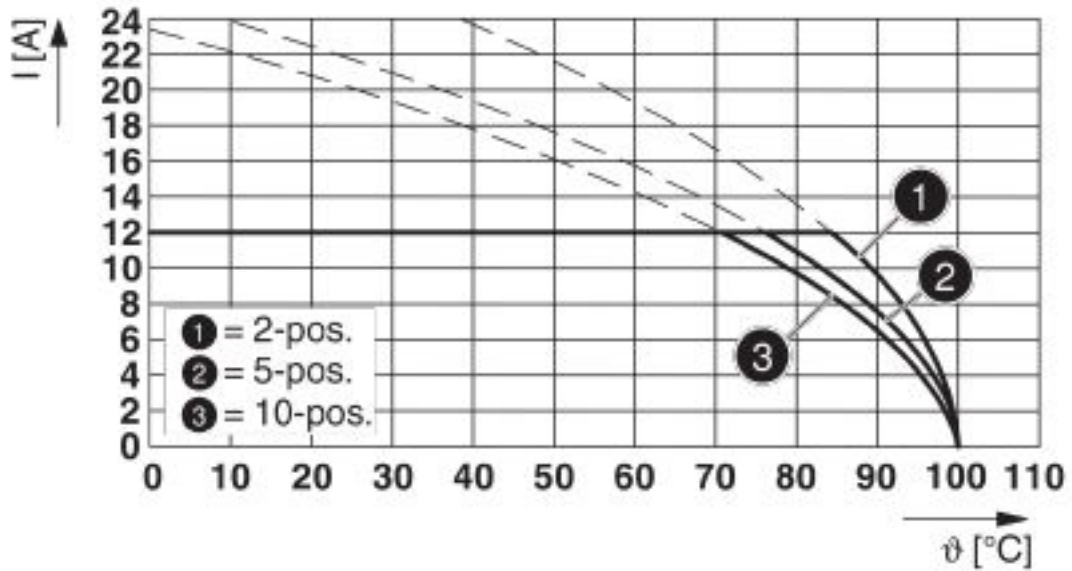

Type: TFKC 2,5/...-ST-5,08 with MSTB 2,5/...-G-5,08

Diagram

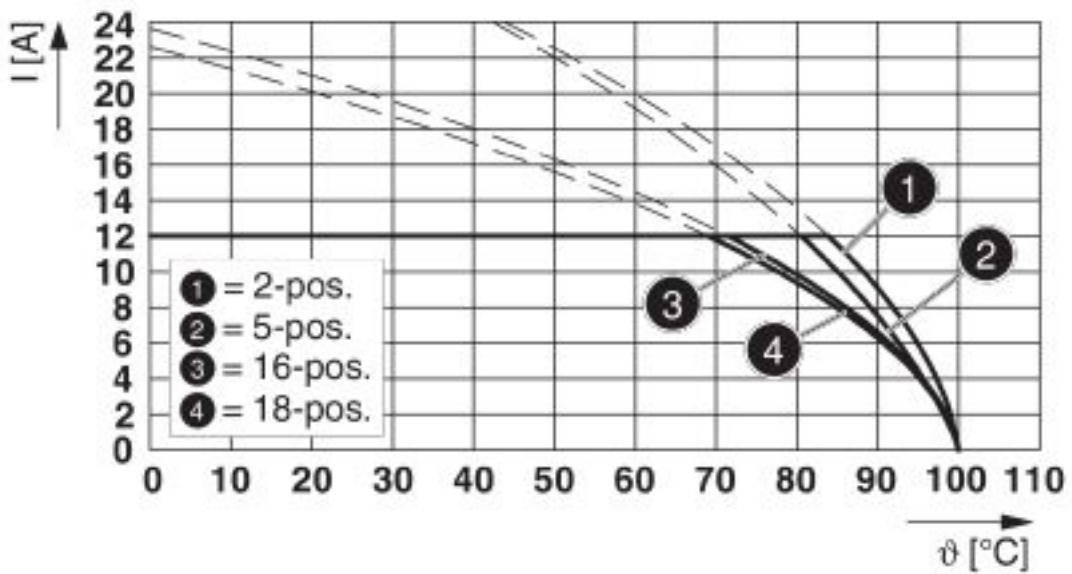

Type: FKC 2,5/...-ST-5,08 with MSTB 2,5/...-G-5,08

# Feed-through header - MSTB 2,5/12-G-5,08 - 1759114

Diagram

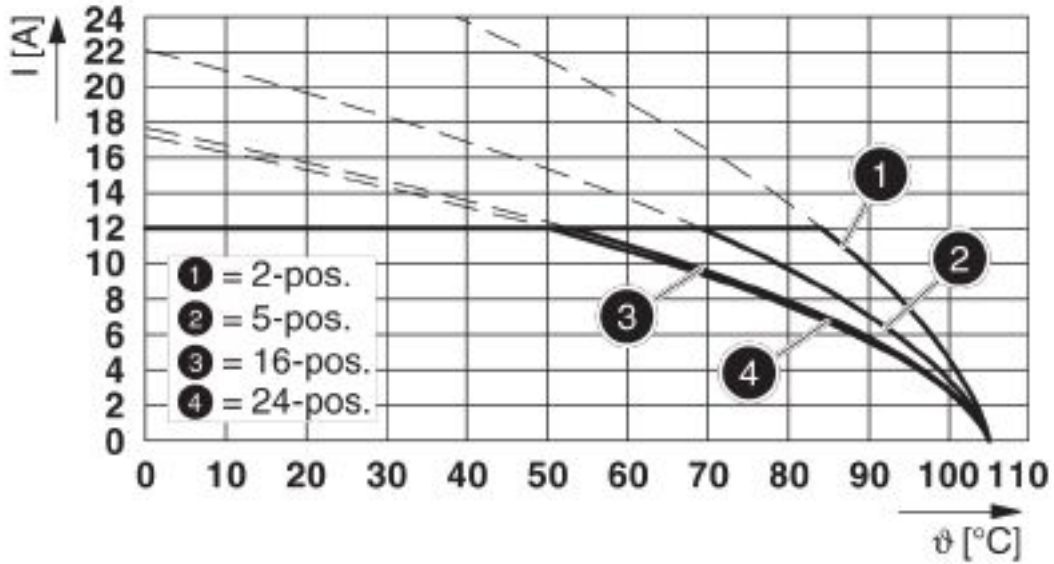

Type: ICV 2,5/...-G-5,08 with MSTB 2,5/...-G-5,08

Diagram

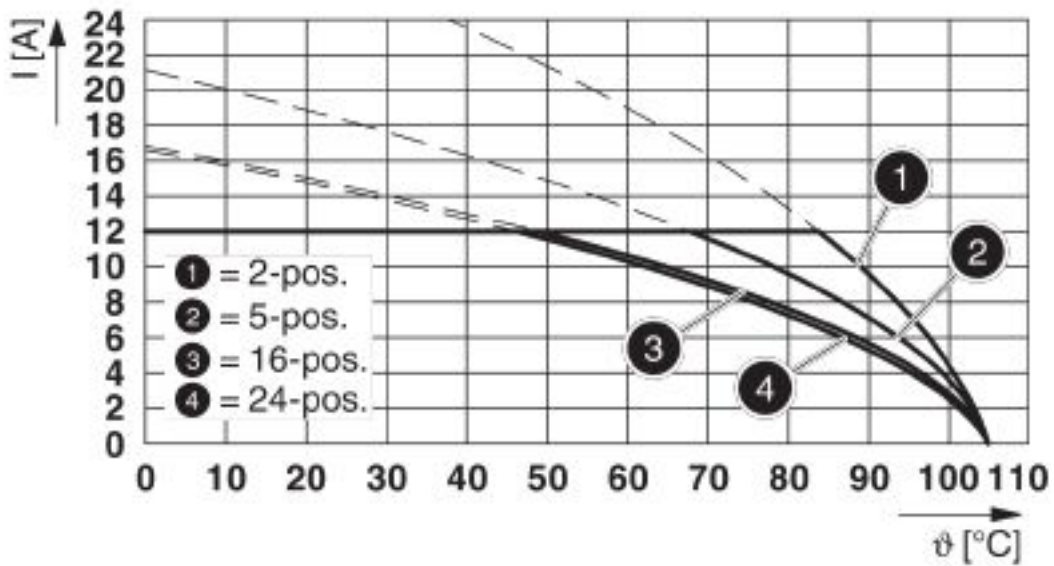

Type: IC 2,5/...-G-5,08 with MSTB 2,5/...-G-5,08

# Feed-through header - MSTB 2,5/12-G-5,08 - 1759114

Dimensional drawing

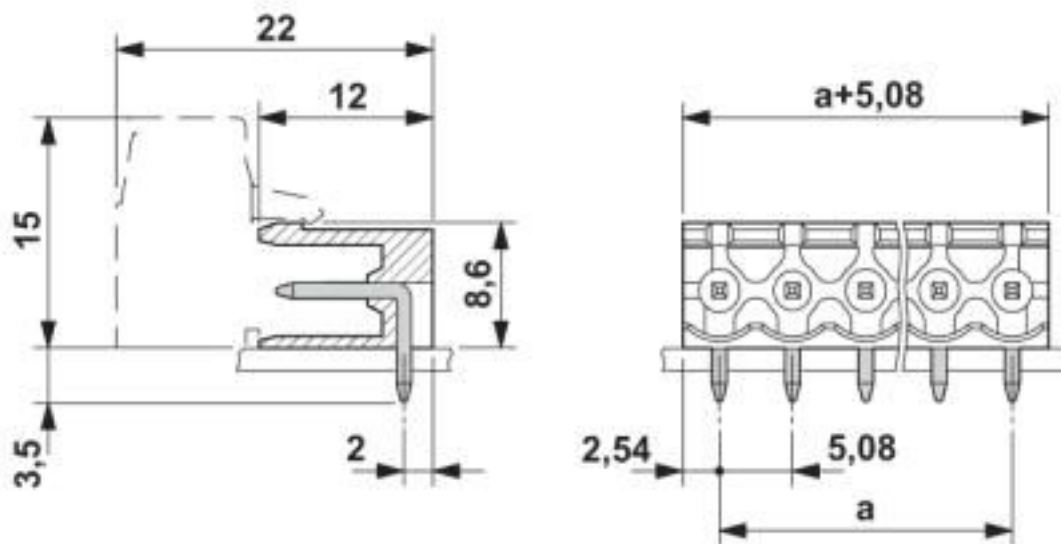

## Classifications

eCl@ss

|               |          |
|---------------|----------|
| eCl@ss 10.0.1 | 27440402 |
| eCl@ss 4.0    | 27260700 |
| eCl@ss 4.1    | 27260700 |
| eCl@ss 5.0    | 27260700 |
| eCl@ss 5.1    | 27260700 |
| eCl@ss 6.0    | 27260700 |
| eCl@ss 7.0    | 27440402 |
| eCl@ss 8.0    | 27440402 |
| eCl@ss 9.0    | 27440402 |

ETIM

|          |          |
|----------|----------|
| ETIM 3.0 | EC001121 |
| ETIM 4.0 | EC002637 |
| ETIM 5.0 | EC002637 |
| ETIM 6.0 | EC002637 |
| ETIM 7.0 | EC002637 |

UNSPSC

|               |          |
|---------------|----------|
| UNSPSC 6.01   | 30211810 |
| UNSPSC 7.0901 | 39121409 |
| UNSPSC 11     | 39121409 |
| UNSPSC 12.01  | 39121409 |
| UNSPSC 13.2   | 39121409 |
| UNSPSC 18.0   | 39121409 |

# Feed-through header - MSTB 2,5/12-G-5,08 - 1759114

## Classifications

### UNSPSC

|             |          |
|-------------|----------|
| UNSPSC 19.0 | 39121409 |
| UNSPSC 20.0 | 39121409 |
| UNSPSC 21.0 | 39121409 |

## Approvals

### Approvals

#### Approvals

CSA / IECCE CB Scheme / EAC / cULus Recognized / VDE Zeichengenehmigung

#### Ex Approvals

## Approval details

|                    |       |   |       |
|--------------------|-------|---|-------|
| CSA                |       | <a href="http://www.csagroup.org/services-industries/product-listing/">http://www.csagroup.org/services-industries/product-listing/</a> | 13631 |
|                    | B     | D   |       |
| Nominal voltage UN | 300 V | 300 V   |       |
| Nominal current IN | 10 A  | 10 A  |       |

|                    |       |   |                |
|--------------------|-------|---|----------------|
| IECEE CB Scheme    |       | <a href="http://www.iecee.org/">http://www.iecee.org/</a> | DE1-60988-B1B2 |
| Nominal voltage UN | 250 V |   |                |
| Nominal current IN | 12 A  |   |                |

|     |  |         |
|-----|--|---------|
| EAC |  | B.01687 |
|-----|--|---------|

|                    |       |   |                 |
|--------------------|-------|---|-----------------|
| cULus Recognized   |       | <a href="http://database.ul.com/cgi-bin/XYV/template/LISEXT/1FRAME/index.htm">http://database.ul.com/cgi-bin/XYV/template/LISEXT/1FRAME/index.htm</a> | E60425-19931011 |
|                    | B     | D   |                 |
| Nominal voltage UN | 300 V | 300 V   |                 |
| Nominal current IN | 15 A  | 10 A  |                 |

# Feed-through header - MSTB 2,5/12-G-5,08 - 1759114

## Approvals

|                        |  |   |          |
|------------------------|--|---|----------|
| VDE Zeichengenehmigung |  | <a href="http://www2.vde.com/de/Institut/Online-Service/VDE-gepruefteProdukte/Seiten/Online-Suche.aspx">http://www2.vde.com/de/Institut/Online-Service/VDE-gepruefteProdukte/Seiten/Online-Suche.aspx</a> | 40050648 |
| Nominal voltage UN     |  | 250 V   |          |
| Nominal current IN     |  | 12 A  |          |

## Accessories

### Accessories

#### Coding element

Coding section - CR-MSTB - 1734401

Coding section, inserted into the recess in the header or the inverted plug, red insulating material



---

#### Filler plug

Accessories - MSTB-BL - 1755477



Keying cap, for forming sections, plugs onto header pin, green insulating material

---

#### Flange

Accessories - MSTB-BF - 1759981



Mounting flange, for fixing both ends of the header onto the PCB, green insulating material, with M 2 x 14 screws and nuts.

---

#### Labeled terminal marker

## Feed-through header - MSTB 2,5/12-G-5,08 - 1759114

### Accessories

Marker card - SK 5,08/3,8:FORTL.ZAHLEN - 0804293



Marker card, Card, white, labeled, horizontal: consecutive numbers 1 ... 10, 11 ... 20, etc. up to 91 ... (99)100, mounting type: adhesive, for terminal block width: 5.08 mm, lettering field size: 5.08 x 3.8 mm

---

### Marker pen

Marker pen - B-STIFT - 1051993



Marker pen, for manual labeling of unprinted Zack strips, smear-proof and waterproof, line thickness 0.5 mm

---

### Terminal marking

Marker card - SK 5,08/3,8:UNBEDRUCKT - 0805412



Marker card, Card, white, unlabeled, can be labeled with: Marker pen, mounting type: adhesive, for terminal block width: 5.08 mm, lettering field size: 5.08 x 3.8 mm

---

### Additional products

Printed-circuit board connector - FKCN 2,5/12-ST-5,08 - 1754665



PCB connector, nominal current: 12 A, rated voltage (III/2): 320 V, nominal cross section: 2.5 mm<sup>2</sup>, number of positions: 12, pitch: 5.08 mm, connection method: Push-in spring connection, color: green, contact surface: Tin

Printed-circuit board connector - MSTB 2,5/12-ST-5,08 - 1757116



PCB connector, nominal current: 12 A, rated voltage (III/2): 320 V, nominal cross section: 2.5 mm<sup>2</sup>, number of positions: 12, pitch: 5.08 mm, connection method: Screw connection with tension sleeve, color: green, contact surface: Tin

## Feed-through header - MSTB 2,5/12-G-5,08 - 1759114

### Accessories

#### Printed-circuit board connector - MSTB 2,5/12-STZ-5,08 - 1764280



PCB connector, nominal current: 12 A, rated voltage (III/2): 320 V, nominal cross section: 2.5 mm<sup>2</sup>, number of positions: 12, pitch: 5.08 mm, connection method: Screw connection with tension sleeve, color: green, contact surface: Tin

#### Printed-circuit board connector - MSTBP 2,5/12-ST-5,08 - 1769117



PCB connector, nominal current: 12 A, rated voltage (III/2): 320 V, nominal cross section: 2.5 mm<sup>2</sup>, number of positions: 12, pitch: 5.08 mm, connection method: Screw connection with tension sleeve, color: green, contact surface: Tin

#### Printed-circuit board connector - FRONT-MSTB 2,5/12-ST-5,08 - 1777387



PCB connector, nominal current: 12 A, rated voltage (III/2): 320 V, nominal cross section: 2.5 mm<sup>2</sup>, number of positions: 12, pitch: 5.08 mm, connection method: Front screw connection, color: green, contact surface: Tin

#### Printed-circuit board connector - MSTBT 2,5/12-ST-5,08 - 1781085



PCB connector, nominal current: 12 A, rated voltage (III/2): 320 V, nominal cross section: 2.5 mm<sup>2</sup>, number of positions: 12, pitch: 5.08 mm, connection method: Screw connection with tension sleeve, color: green, contact surface: Tin

#### Printed-circuit board connector - MVSTBR 2,5/12-ST-5,08 - 1792346



PCB connector, nominal current: 12 A, rated voltage (III/2): 320 V, nominal cross section: 2.5 mm<sup>2</sup>, number of positions: 12, pitch: 5.08 mm, connection method: Screw connection with tension sleeve, color: green, contact surface: Tin



## Feed-through header - MSTB 2,5/12-G-5,08 - 1759114

### Accessories

#### Printed-circuit board connector - MVSTBW 2,5/12-ST-5,08 - 1792854



PCB connector, nominal current: 12 A, rated voltage (III/2): 320 V, nominal cross section: 2.5 mm<sup>2</sup>, number of positions: 12, pitch: 5.08 mm, connection method: Screw connection with tension sleeve, color: green, contact surface: Tin

#### Printed-circuit board connector - MSTBC 2,5/12-ST-5,08 - 1808913



PCB connector, nominal current: 12 A, rated voltage (III/2): 320 V, nominal cross section: 2.5 mm<sup>2</sup>, number of positions: 12, pitch: 5.08 mm, connection method: Crimp connection, color: green, Corresponding female crimp contacts with current [A] and conductor cross section range [mm<sup>2</sup>] data: 10A/MSTBC-MT 0,5-1,0 (3190564); 10A/MSTBC-MT 0,5-1,0 BA (3190645); 12A/MSTBC-MT 1,5-2,5 (3190551); 12A/MSTBC-MT 1,5-2,5 BA (3190658). BA = Bandkontakte

#### Printed-circuit board connector - MSTBC 2,5/12-STZ-5,08 - 1809608



PCB connector, nominal current: 12 A, rated voltage (III/2): 320 V, nominal cross section: 2.5 mm<sup>2</sup>, number of positions: 12, pitch: 5.08 mm, connection method: Crimp connection, color: green, Corresponding female crimp contacts with current [A] and conductor cross section range [mm<sup>2</sup>] data: 10A/MSTBC-MT 0,5-1,0 (3190564); 10A/MSTBC-MT 0,5-1,0 BA (3190645); 12A/MSTBC-MT 1,5-2,5 (3190551); 12A/MSTBC-MT 1,5-2,5 BA (3190658). BA = Bandkontakte

#### Printed-circuit board connector - MSTBU 2,5/12-STD-5,08 - 1824227



Direct plug-in block, nominal current: 12 A, rated voltage (III/2): 320 V, nominal cross section: 2.5 mm<sup>2</sup>, number of positions: 12, pitch: 5.08 mm, connection method: Screw connection with tension sleeve, color: green, contact surface: Tin, mounting: Direct mounting

#### Printed-circuit board connector - MSTBU 2,5/12-ST-5,08-FL - 1824450



Direct plug-in block, nominal current: 12 A, rated voltage (III/2): 320 V, nominal cross section: 2.5 mm<sup>2</sup>, number of positions: 12, pitch: 5.08 mm, connection method: Screw connection with tension sleeve, color: green, contact surface: Tin, mounting: Direct mounting

## Feed-through header - MSTB 2,5/12-G-5,08 - 1759114

### Accessories

#### Printed-circuit board connector - SMSTB 2,5/12-ST-5,08 - 1826380



PCB connector, nominal current: 12 A, rated voltage (III/2): 320 V, nominal cross section: 2.5 mm<sup>2</sup>, number of positions: 12, pitch: 5.08 mm, connection method: Screw connection with tension sleeve, color: green, contact surface: Tin

#### Printed-circuit board connector - MSTBVK 2,5/12-ST-5,08 - 1831414



DIN rail connector, nominal current: 12 A, rated voltage (III/2): 320 V, nominal cross section: 2.5 mm<sup>2</sup>, number of positions: 12, pitch: 5.08 mm, connection method: Screw connection with tension sleeve, color: green, contact surface: Tin, mounting: DIN rail

#### Printed-circuit board connector - UMSTBVK 2,5/12-ST-5,08 - 1833917



DIN rail connector, nominal current: 12 A, rated voltage (III/2): 320 V, nominal cross section: 2.5 mm<sup>2</sup>, number of positions: 12, pitch: 5.08 mm, connection method: Screw connection with tension sleeve, color: green, contact surface: Tin, mounting: DIN rail

#### Printed-circuit board connector - FKCVW 2,5/12-ST-5,08 - 1873757



PCB connector, nominal current: 12 A, rated voltage (III/2): 320 V, nominal cross section: 2.5 mm<sup>2</sup>, number of positions: 12, pitch: 5.08 mm, connection method: Push-in spring connection, color: green, contact surface: Tin

#### Printed-circuit board connector - FKCVW 2,5/12-ST-5,08 - 1873757



PCB connector, nominal current: 12 A, rated voltage (III/2): 320 V, nominal cross section: 2.5 mm<sup>2</sup>, number of positions: 12, pitch: 5.08 mm, connection method: Push-in spring connection, color: green, contact surface: Tin

## Feed-through header - MSTB 2,5/12-G-5,08 - 1759114

### Accessories

Printed-circuit board connector - FKCVR 2,5/12-ST-5,08 - 1874057



PCB connector, nominal current: 12 A, rated voltage (III/2): 320 V, nominal cross section: 2.5 mm<sup>2</sup>, number of positions: 12, pitch: 5.08 mm, connection method: Push-in spring connection, color: green, contact surface: Tin

Printed-circuit board connector - QC 1/12-ST-5,08 - 1883705



PCB connector, nominal current: 10 A, rated voltage (III/2): 630 V, nominal cross section: 1 mm<sup>2</sup>, number of positions: 12, pitch: 5.08 mm, connection method: Displacement connection, color: green, contact surface: Tin

Printed-circuit board connector - FKCT 2,5/12-ST-5,08 - 1902217



PCB connector, nominal current: 12 A, rated voltage (III/2): 320 V, nominal cross section: 2.5 mm<sup>2</sup>, number of positions: 12, pitch: 5.08 mm, connection method: Push-in spring connection, color: green, contact surface: Tin

Printed-circuit board connector - FKCS 2,5/12-ST-5,08 - 1975176



PCB connector, nominal current: 12 A, rated voltage (III/2): 320 V, nominal cross section: 2.5 mm<sup>2</sup>, number of positions: 12, pitch: 5.08 mm, connection method: Push-in spring connection, color: green, contact surface: Tin

Phoenix Contact 2020 © - all rights reserved  
<http://www.phoenixcontact.com>

PHOENIX CONTACT GmbH & Co. KG  
Flachsmarktstr. 8  
32825 Blomberg  
Germany  
Tel. +49 5235 300  
Fax +49 5235 3 41200  
<http://www.phoenixcontact.com>

# Mouser Electronics

Authorized Distributor

Click to View Pricing, Inventory, Delivery & Lifecycle Information:

[Phoenix Contact:](#)

[1759114](#)