

Printed-circuit board connector - FMC 1,5/18-ST-3,81 - 1748134

Please be informed that the data shown in this PDF Document is generated from our Online Catalog. Please find the complete data in the user's documentation. Our General Terms of Use for Downloads are valid (<http://phoenixcontact.com/download>)

PCB connector, nominal current: 8 A, rated voltage (III/2): 160 V, nominal cross section: 1.5 mm², number of positions: 18, pitch: 3.81 mm, connection method: Push-in spring connection, color: green, contact surface: Tin



The figure shows a 10-position version of the product

Your advantages

- Time saving push-in connection, tools not required
- Defined contact force ensures that contact remains stable over the long term
- Intuitive use through colour coded actuation lever
- Operation and conductor connection from one direction enable integration into front of device



Key Commercial Data

Packing unit	50 pc
GTIN	 4 046356 311175
GTIN	4046356311175

Technical data

Item properties

Brief article description	Printed-circuit board connector
Plug-in system	MINI COMBICON
Type of contact	Female connector
Range of articles	FMC 1,5/...-ST
Pitch	3.81 mm
Number of positions	18
Connection method	Push-in spring connection
Locking	without
Number of levels	1
Number of connections	18
Number of potentials	18

Printed-circuit board connector - FMC 1,5/18-ST-3,81 - 1748134

Technical data

Electrical parameters

Nominal current	8 A
Nom. voltage	160 V
Rated voltage	160 V
Rated voltage (III/2)	160 V
Rated voltage (II/2)	320 V
Rated surge voltage (III/3)	2.5 kV
Rated surge voltage (III/2)	2.5 kV
Rated surge voltage (II/2)	2.5 kV

Connection capacity

Connection method	Push-in spring connection
pluggable	Yes
Conductor cross section solid	0.2 mm ² ... 1.5 mm ²
Conductor cross section flexible	0.2 mm ² ... 1.5 mm ²
Conductor cross section AWG / kcmil	24 ... 16
Conductor cross section flexible, with ferrule without plastic sleeve	0.25 mm ² ... 1.5 mm ²
Conductor cross section, flexible, with ferrule, with plastic sleeve	0.14 mm ² ... 0.75 mm ²
Cylindrical gauge a x b / diameter	2.4 mm x 1.5 mm / 1.6 mm
Stripping length	10 mm

Specifications for ferrules

Recommended crimping pliers	1212034 CRIMPFOX 6
Ferrules without insulating collar, according to DIN 46228-1	Cross section: 0.25 mm ² ; Length: 7 mm
	Cross section: 0.34 mm ² ; Length: 7 mm
	Cross section: 0.5 mm ² ; Length: 8 mm ... 10 mm
	Cross section: 0.75 mm ² ; Length: 8 mm ... 10 mm
	Cross section: 1 mm ² ; Length: 8 mm ... 10 mm
	Cross section: 1.5 mm ² ; Length: 10 mm
Recommended crimping pliers	1212034 CRIMPFOX 6
Ferrules with insulating collar, according to DIN 46228-4	Cross section: 0.14 mm ² ; Length: 8 mm
	Cross section: 0.25 mm ² ; Length: 8 mm ... 10 mm
	Cross section: 0.34 mm ² ; Length: 8 mm ... 10 mm
	Cross section: 0.5 mm ² ; Length: 8 mm ... 10 mm
	Cross section: 0.75 mm ² ; Length: 10 mm

Material data - contact

Note	WEEE/RoHS-compliant, free of whiskers according to IEC 60068-2-82/ JEDEC JESD 201
Contact material	Cu alloy
Surface characteristics	hot-dip tin-plated
Metal surface terminal point (top layer)	Tin (4 - 8 µm Sn)
Metal surface contact area (top layer)	Tin (4 - 8 µm Sn)

Printed-circuit board connector - FMC 1,5/18-ST-3,81 - 1748134

Technical data

Material data - housing

Housing color	green (6021)
Insulating material	PA
Insulating material group	I
CTI according to IEC 60112	600
Flammability rating according to UL 94	V0
Glow wire flammability index GWFI according to EN 60695-2-12	850
Glow wire ignition temperature GWIT according to EN 60695-2-13	775
Temperature for the ball pressure test according to EN 60695-10-2	125 °C

Material data – actuating element

Insulating material	PBT
CTI according to IEC 60112	600
Flammability rating according to UL 94	V0

Dimensions for the product

Length [l]	21.9 mm
Width [w]	69.02 mm
Height [h]	7.75 mm
Pitch	3.81 mm
Height (without solder pin)	7.75 mm

Packaging information

Type of packaging	packed in cardboard
Pieces per package	50
Denomination packing units	Pcs.

Ambient conditions

Ambient temperature (storage/transport)	-40 °C ... 70 °C
Ambient temperature (assembly)	-5 °C ... 100 °C
Ambient temperature (operation)	-40 °C ... 100 °C (dependent on the derating curve)

Termination and connection method

Conductor connection test	The stripped-off ends of the largest conductor can be completely inserted in the opening of the terminal point without using excessive force.
Test result	Test passed
Test – repeated connection and release	IEC 60999-1:1999-11
	Test passed
Test for conductor damage and slackening	IEC 60999-1:1999-11
	Test passed

Pull-out test

Pull-out test	IEC 60999-1:1999-11
	Test passed
Conductor cross section / conductor type / tensile force	0.2 mm ² / solid / > 10 N

Printed-circuit board connector - FMC 1,5/18-ST-3,81 - 1748134

Technical data

Pull-out test

	0.2 mm ² / flexible / > 10 N
	1.5 mm ² / solid / > 40 N
	1.5 mm ² / flexible / > 40 N

Mechanical tests according to standard

Test specification	IEC 61984
Visual inspection	IEC 60512-1-1:2002-02
Dimension check	IEC 60512-1-2:2002-02
Resistance of inscriptions	IEC 60068-2-70:1995-12
Insertion and withdrawal force	IEC 60512-13-2:2006-02
No. of cycles	25
Insertion strength per pos. approx.	8 N
Withdraw strength per pos. approx.	5 N
Polarization and coding	IEC 60512-13-5:2006-02
Contact holder in insert	IEC 60512-15-1:2008-05
Test force per pos.	28 N

Air clearances and creepage distances

Clearances and creepage distances	IEC 60664-1:2007-04
Specification	IEC 60664-1:2007-04
Minimum clearance - inhomogeneous field (III/3)	1.5 mm
Minimum clearance - inhomogeneous field (III/2)	1.5 mm
Minimum clearance - inhomogeneous field (II/2)	1.5 mm
Minimum creepage distance value (III/3)	2 mm
Minimum creepage distance value (III/2)	1.5 mm
Minimum creepage distance value (II/2)	1.6 mm

Electrical tests - Function

Specification	IEC 60999-1:1999-11
---------------	---------------------

Temperature cycles

Specification	IEC 60999-1:1999-11
Test current (minimum cross section)	5 A AC
Test current (maximum cross section)	8 A AC
Temperature cycles	192

Current carrying capacity / derating curves

Caption	Type: FMC 1,5/...-ST-3,81 with MCV 1,5/...-G-3,81
Specification	IEC 61984:2008-10
Reduction factor	0.8
Note	Representation based on IEC 60512-5-2:2002-02
	For number of positions, see diagram

Mechanical tests (A)

Printed-circuit board connector - FMC 1,5/18-ST-3,81 - 1748134

Technical data

Mechanical tests (A)

Test specification	IEC 61984
Insertion strength per pos. approx.	8 N
Withdraw strength per pos. approx.	5 N
Polarization when inserted requirement >20 N	Test passed
Contact holder in insert requirements >20 N	Test passed

Durability tests (B)

Specification	IEC 60512-9-1:2010-03
Contact resistance R ₁	1.5 mΩ
Insertion/withdrawal cycles	25
Contact resistance R ₂	1.7 mΩ
Impulse withstand voltage at sea level	2.95 kV
Power-frequency withstand voltage	1.39 kV
Insulation resistance, neighboring positions	> 50 GΩ

Thermal tests (C)

Specification	IEC 60512-5-1:2002-02
Number of positions	20
Conductor cross section	1.5 mm ²
Test current	8 A
Upper limiting temperature requirements <100 °C	Test passed

Climatic tests (D)

Specification	ISO 6988:1985-02
Cold stress	-40 °C/2 h
Thermal stress	100 °C/168 h
Corrosive stress	0.2 dm ³ SO ₂ on 300 dm ³ /40 °C/1 cycle
Impulse withstand voltage at sea level	2.95 kV
Power-frequency withstand voltage	1.39 kV

Environmental and durability tests (E)

Specification	IEC 61984:2008-10
Result, degree of protection, IP code	Finger safety with IP20 test finger

Environmental Product Compliance

China RoHS	Environmentally friendly use period: unlimited = EFUP-e
	No hazardous substances above threshold values

Drawings

Printed-circuit board connector - FMC 1,5/18-ST-3,81 - 1748134

Diagram

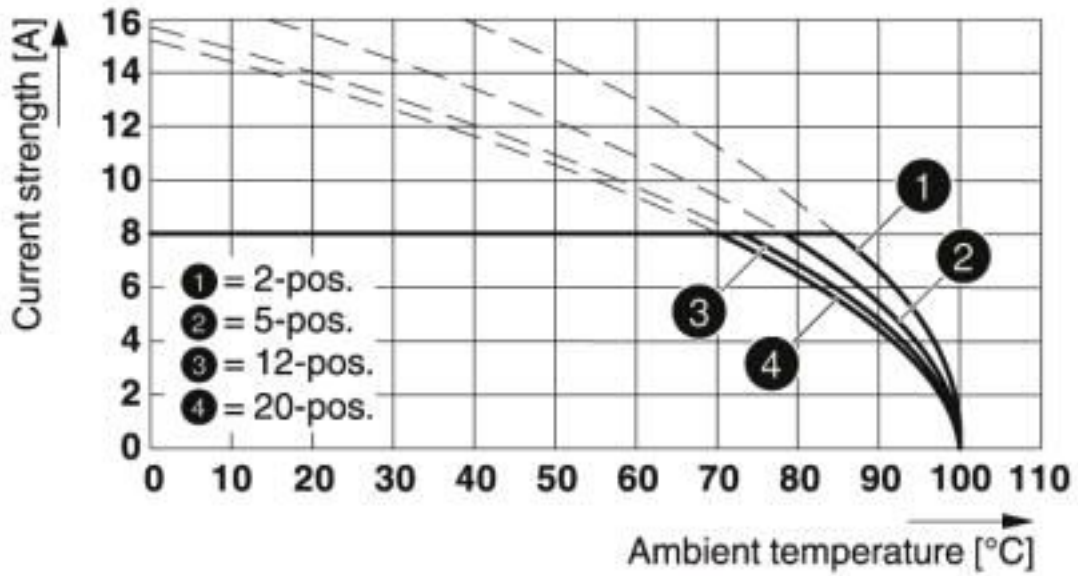

Type: FMC 1,5/...-ST-3,81 with MCV 1,5/...-G-3,81

Diagram

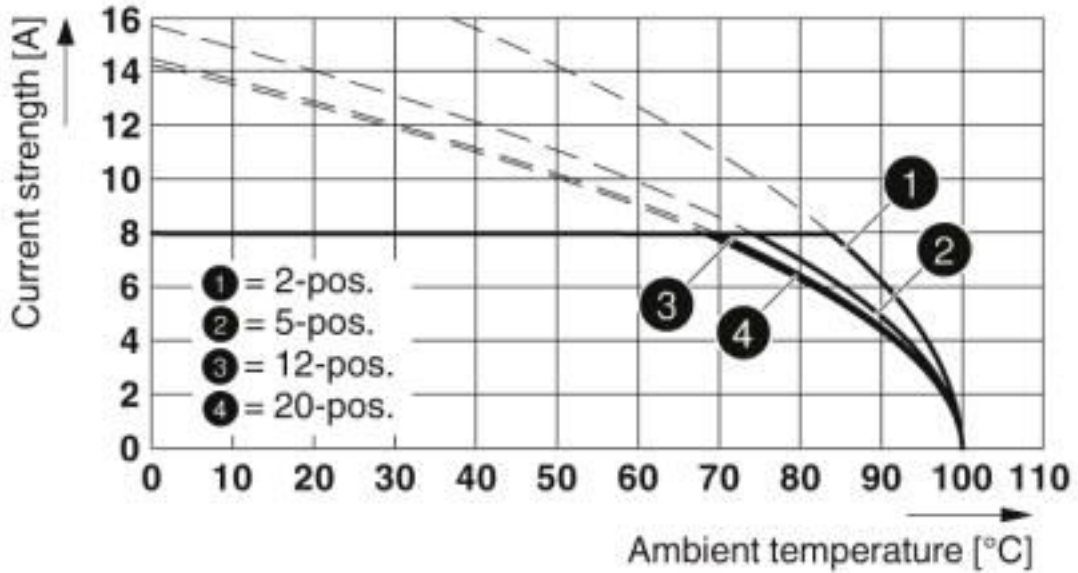

Type: FMC 1,5/...-ST-3,81 with MC 1,5/...-G-3,81

Printed-circuit board connector - FMC 1,5/18-ST-3,81 - 1748134

Diagram

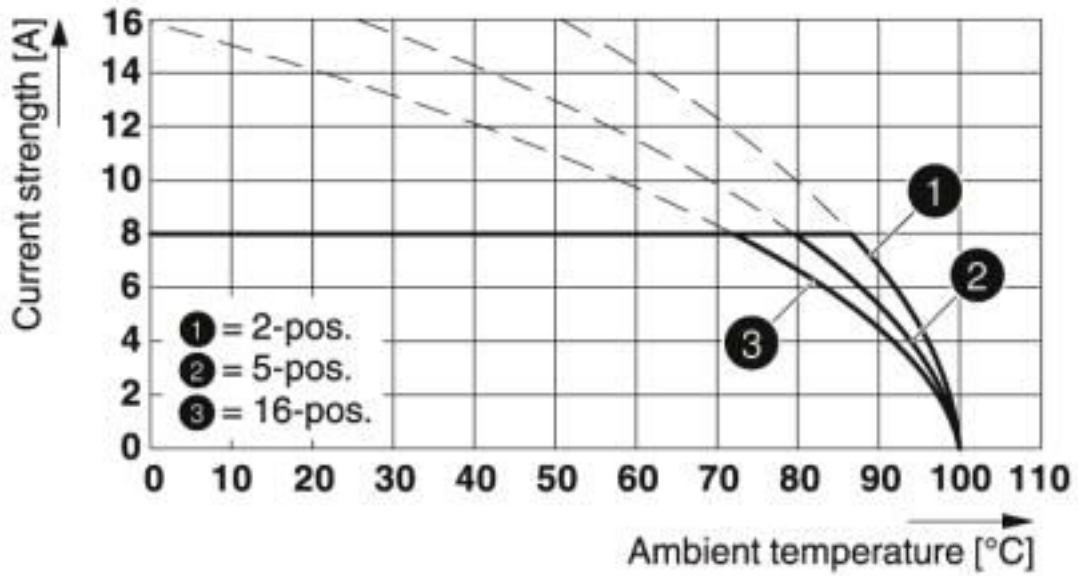

Type: FMC 1,5/...-ST-3,81 with SMC 1,5/...-G-3,81

Diagram

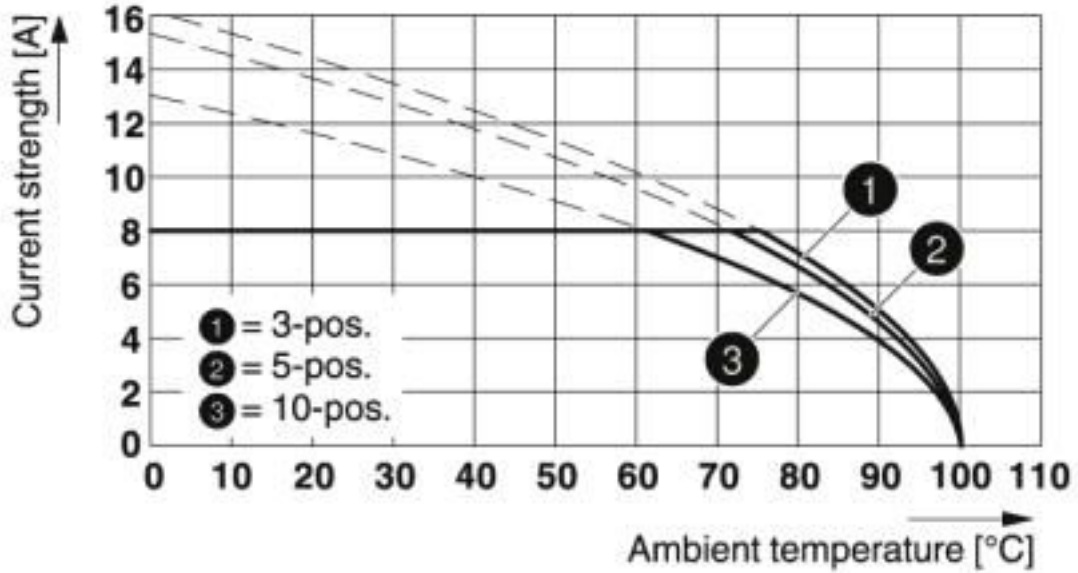

Printed-circuit board connector - FMC 1,5/18-ST-3,81 - 1748134

Diagram

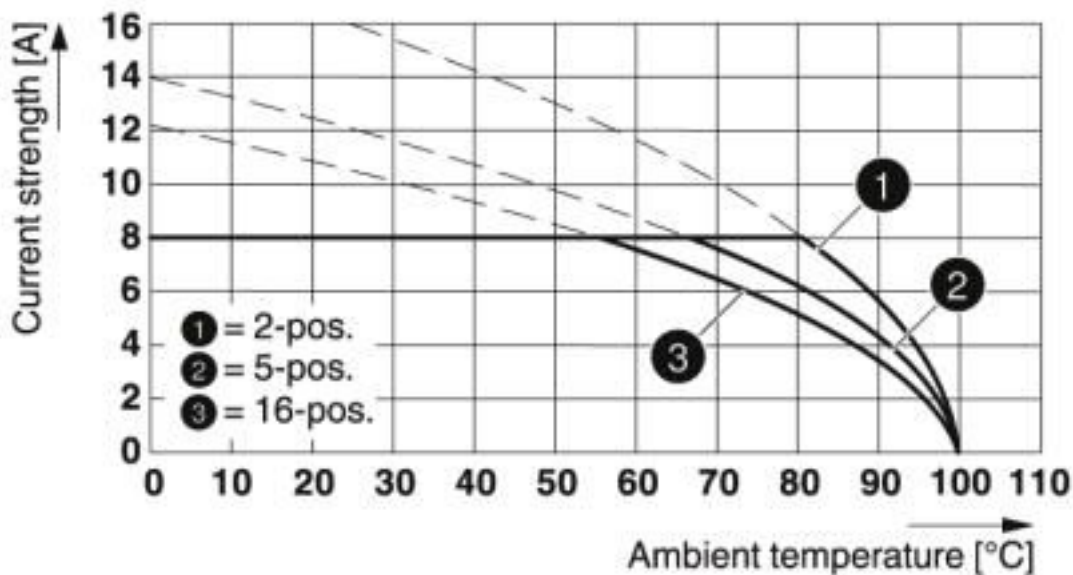

Type: FMC 1,5/...-ST-3,81 with MCD 1,5/...-G-3,81

Diagram

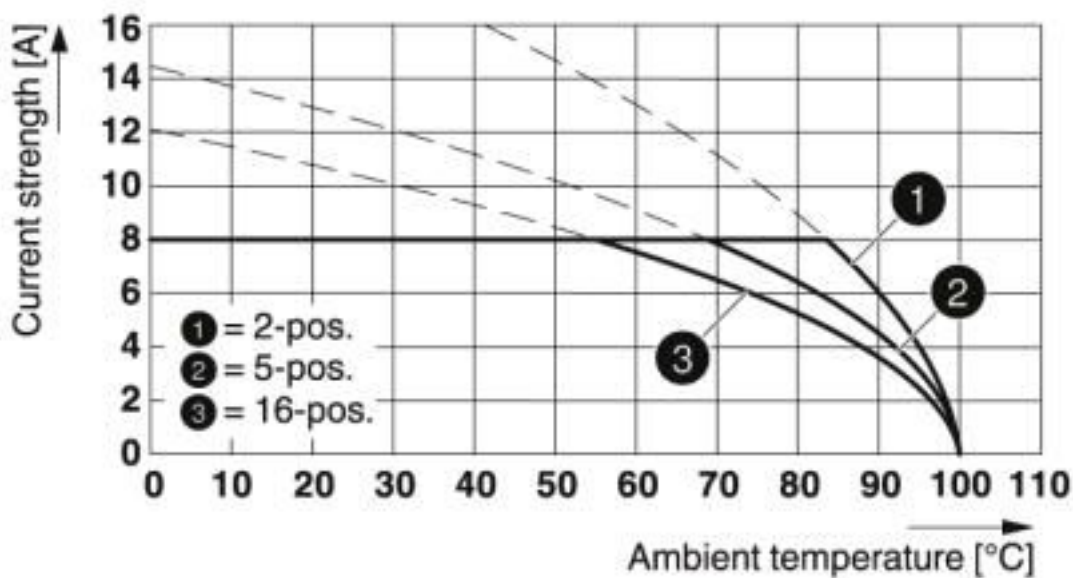

Type: FMC 1,5/...-ST-3,81 with MCD 1,5/...-G1-3,81

Printed-circuit board connector - FMC 1,5/18-ST-3,81 - 1748134

Diagram

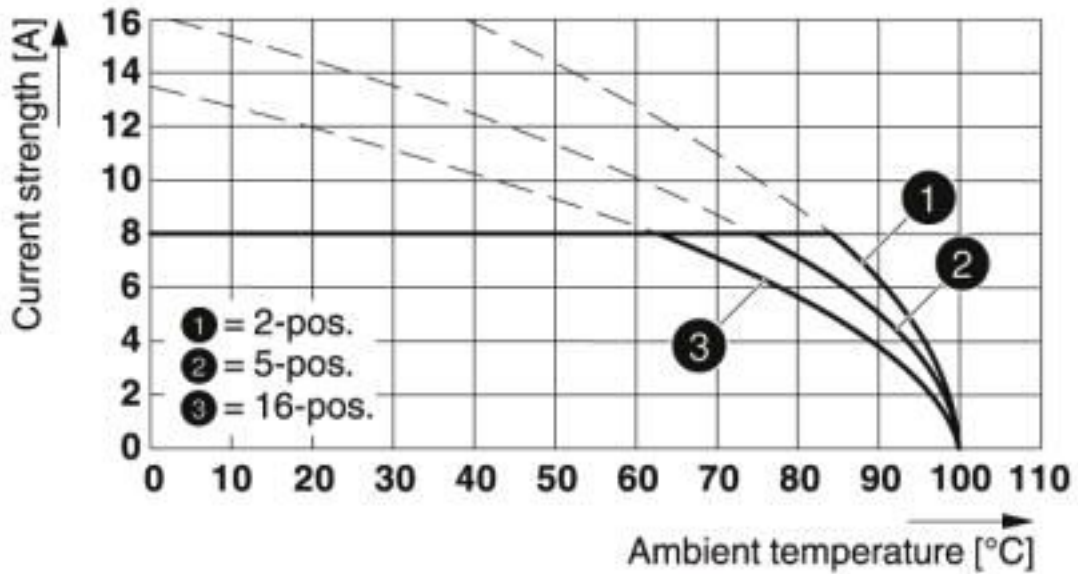

Type: FMC 1,5/...-ST-3,81 with MCDV 1,5/...-G-3,81

Diagram

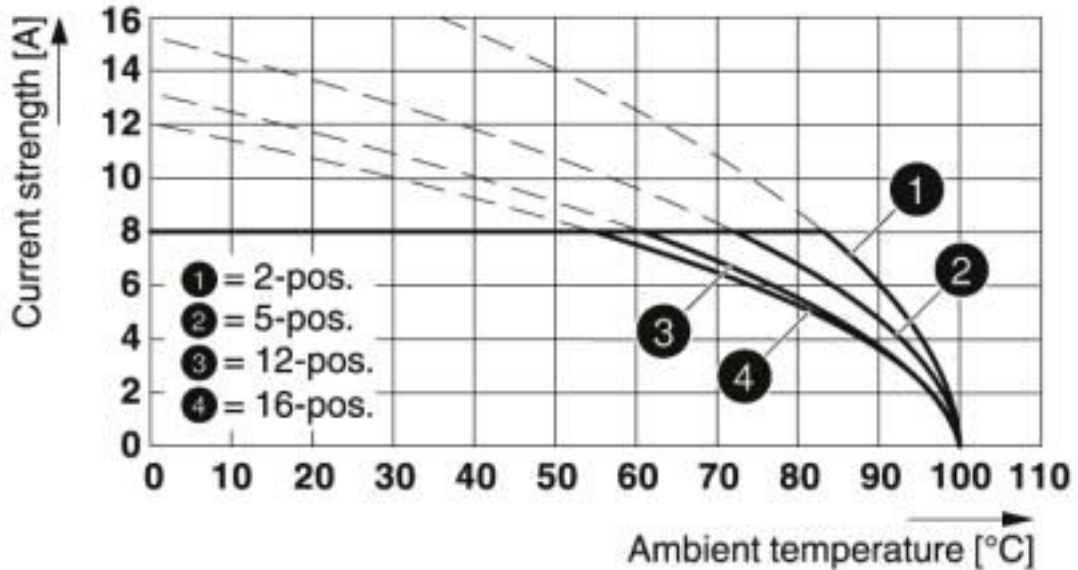

Type: FMC 1,5/...-ST-3,81 with MCDV 1,5/...-G1-3,81

Printed-circuit board connector - FMC 1,5/18-ST-3,81 - 1748134

Diagram

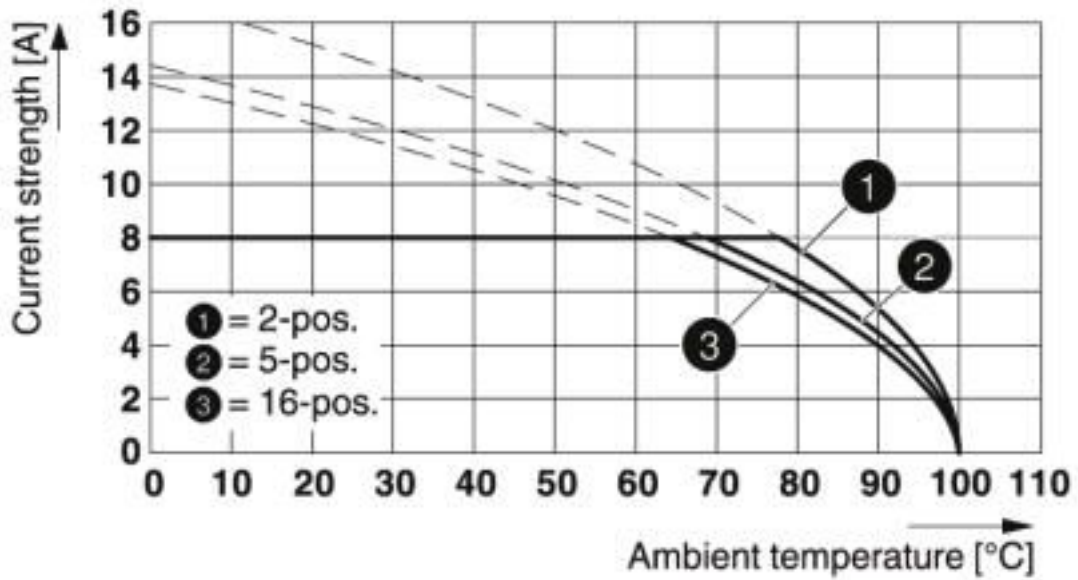

Type: FMC 1,5/...-ST-3,81 with MCVU 1,5/...-GFD-3,81

Diagram

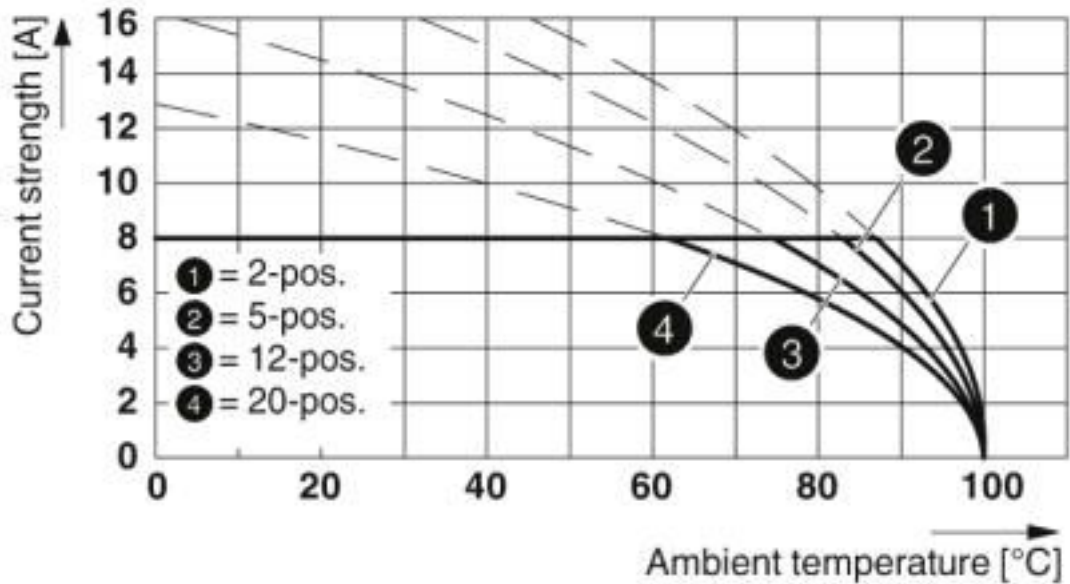

Type: FMC 1,5/...-ST-3,81 with MCV 1,5/...-G-3,81 P.. THR

Printed-circuit board connector - FMC 1,5/18-ST-3,81 - 1748134

Diagram

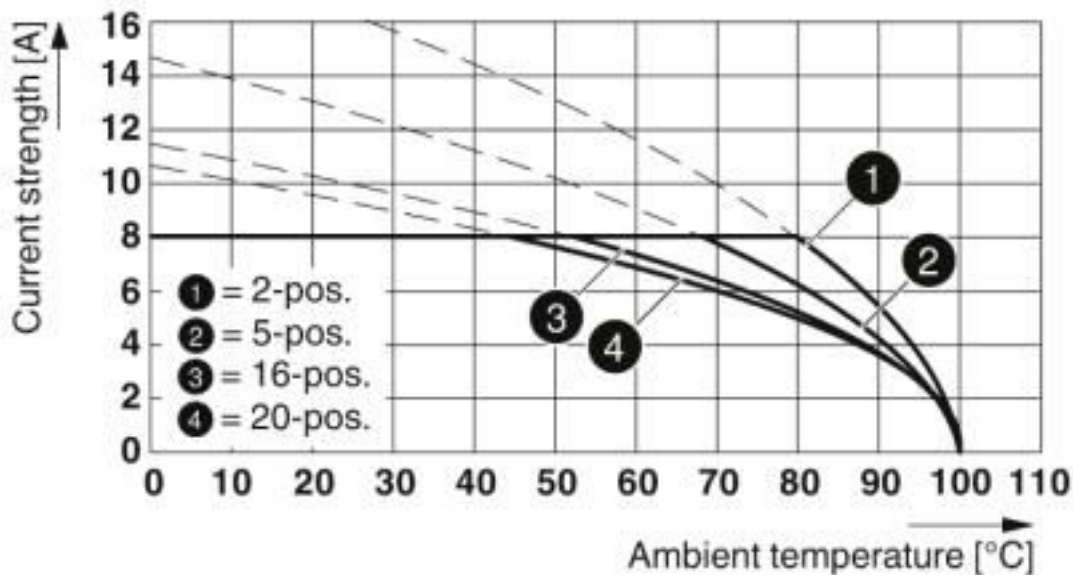

Type: FMC 1,5/...-ST-3,81 with MCDN 1,5/...-G1-3,81 P...THR

Diagram

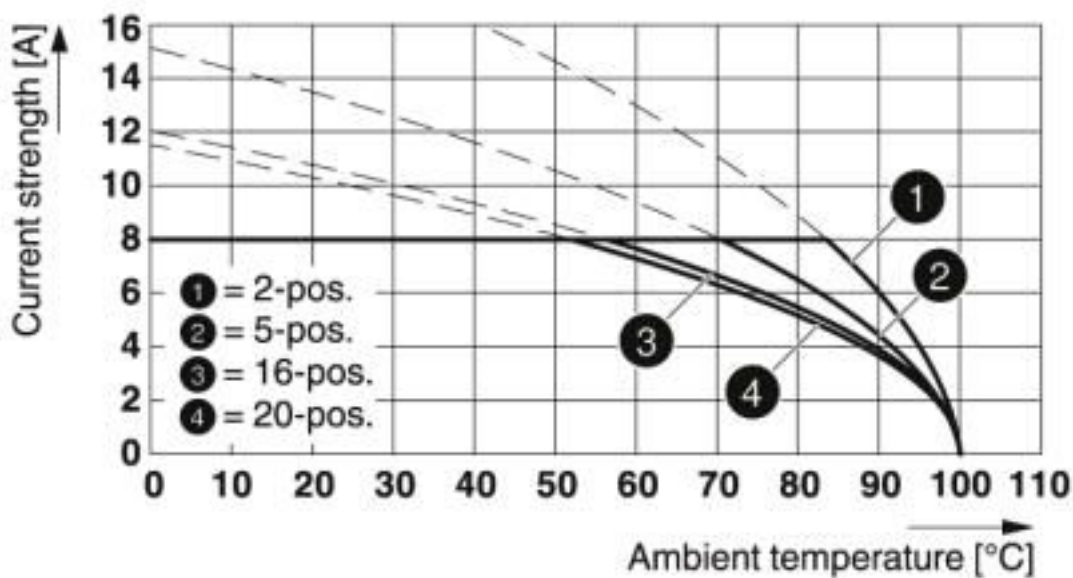

Type: FMC 1,5/...-ST-3,81 with MCDNV 1,5/...-G1-3,81 P...THR

Printed-circuit board connector - FMC 1,5/18-ST-3,81 - 1748134

Dimensional drawing

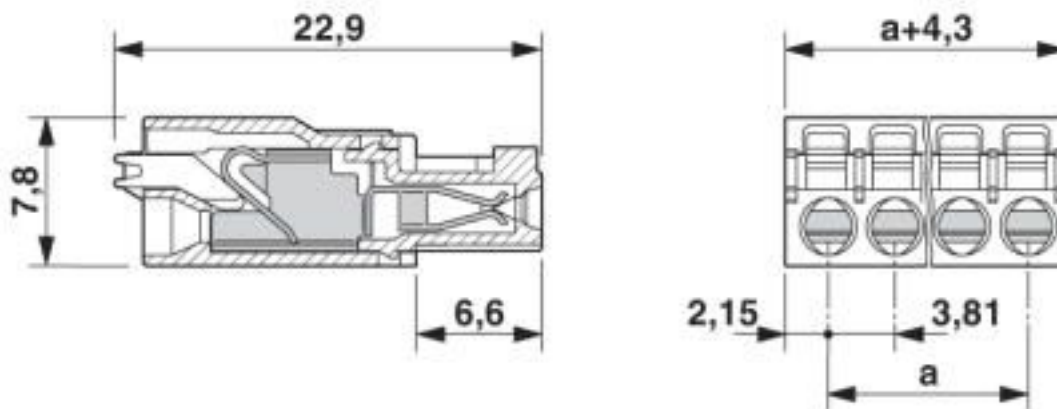

Classifications

eCl@ss

eCl@ss 10.0.1	27440309
eCl@ss 4.0	27260700
eCl@ss 4.1	27260700
eCl@ss 5.0	27260700
eCl@ss 5.1	27260700
eCl@ss 6.0	27260700
eCl@ss 7.0	27440309
eCl@ss 8.0	27440309
eCl@ss 9.0	27440309

ETIM

ETIM 3.0	EC001121
ETIM 4.0	EC002638
ETIM 5.0	EC002638
ETIM 6.0	EC002638
ETIM 7.0	EC002638

UNSPSC

UNSPSC 6.01	30211810
UNSPSC 7.0901	39121409
UNSPSC 11	39121409
UNSPSC 12.01	39121409
UNSPSC 13.2	39121409
UNSPSC 18.0	39121409
UNSPSC 19.0	39121409
UNSPSC 20.0	39121409
UNSPSC 21.0	39121409

Printed-circuit board connector - FMC 1,5/18-ST-3,81 - 1748134

Approvals

Approvals

Approvals

IECEE CB Scheme / VDE Gutachten mit Fertigungsüberwachung / EAC / cULus Recognized

Ex Approvals

Approval details

IECEE CB Scheme		http://www.iecee.org/	DE1-60987-B1B2
Nominal voltage UN	160 V		
Nominal current IN	8 A		
mm ² /AWG/kcmil	0.2-1.5		

VDE Gutachten mit Fertigungsüberwachung		http://www2.vde.com/de/Institut/Online-Service/VDE-gepruefteProdukte/Seiten/Online-Suche.aspx	40011723
Nominal voltage UN	160 V		
Nominal current IN	8 A		
mm ² /AWG/kcmil	0.2-1.5		

EAC		B.01687
-----	--	---------

cULus Recognized		http://database.ul.com/cgi-bin/XYV/template/LISEXT/1FRAME/index.htm	E60425-19920306
	B	C	
Nominal voltage UN	300 V	50 V	
Nominal current IN	8 A	8 A	
mm ² /AWG/kcmil	24-16	24-16	

Accessories

Accessories

Crimping tool

Printed-circuit board connector - FMC 1,5/18-ST-3,81 - 1748134

Accessories

Crimping pliers - CRIMPFOX 6 - 1212034



Crimping pliers, for ferrules without insulating collar according to DIN 46228 Part 1 and ferrules with insulating collar according to DIN 46228 Part 4, 0.25 mm² ... 6.0 mm², lateral entry, trapezoidal crimp

Labeled terminal marker

Marker card - SK 3,81/2,8:FORTL.ZAHLEN - 0804109



Marker card, Card, white, labeled, horizontal: consecutive numbers 1 ... 10, 11 ... 20, etc. up to 91 ... (99)100, mounting type: adhesive, for terminal block width: 3.81 mm, lettering field size: 3.81 x 2.8 mm

Screwdriver tools

Screwdriver - SZS 0,4X2,5 VDE - 1205037



Screwdriver, slot-headed, VDE insulated, size: 0.4 x 2.5 x 80 mm, 2-component grip, with non-slip grip

Additional products

Feed-through header - MCDN 1,5/18-G1-3,81 P14THR - 1749492



PCB headers, nominal current: 8 A, rated voltage (III/2): 160 V, nominal cross section: 1.5 mm², number of positions: 18, pitch: 3.81 mm, color: black, contact surface: Tin, mounting: THR soldering, pin layout: Linear pinning, solder pin [P]: 1.4 mm, The pin length is 1.4 mm. User information and design recommendations on Through Hole Reflow Technology can be found at: "Downloads".

Printed-circuit board connector - MCDN 1,5/18-G1-3,81 P26THR - 1749683



PCB headers, nominal current: 8 A, rated voltage (III/2): 160 V, nominal cross section: 1.5 mm², number of positions: 18, pitch: 3.81 mm, color: black, contact surface: Tin, mounting: THR soldering, pin layout: Linear pinning, solder pin [P]: 2.6 mm, The pin length is 2.6 mm. User information and design recommendations on Through Hole Reflow Technology can be found at: "Downloads"

Printed-circuit board connector - FMC 1,5/18-ST-3,81 - 1748134

Accessories

Feed-through header - MCDNV 1,5/18-G1-3,81 P14THR - 1750261



PCB headers, nominal current: 8 A, rated voltage (III/2): 160 V, nominal cross section: 1.5 mm², number of positions: 18, pitch: 3.81 mm, color: black, contact surface: Tin, mounting: THR soldering, pin layout: Linear pinning, solder pin [P]: 1.4 mm, The pin length is 1.4 mm. User information and design recommendations on Through Hole Reflow Technology can be found at: Downloads".

Printed-circuit board connector - MCDNV 1,5/18-G1-3,81 P26THR - 1750452



PCB headers, nominal current: 8 A, rated voltage (III/2): 160 V, nominal cross section: 1.5 mm², number of positions: 18, pitch: 3.81 mm, color: black, contact surface: Tin, mounting: THR soldering, pin layout: Linear pinning, solder pin [P]: 2.6 mm, The pin length is 26 mm. User information and design recommendations on Through Hole Reflow Technology can be found at: [http: "Downloads"](http://www.phoenixcontact.com/Downloads).

Printed-circuit board connector - MC 1,5/18-G-3,81 - 1841297



PCB headers, nominal current: 8 A, rated voltage (III/2): 160 V, nominal cross section: 1.5 mm², number of positions: 18, pitch: 3.81 mm, color: green, contact surface: Tin, mounting: Wave soldering, pin layout: Linear pinning, solder pin [P]: 3.4 mm

Printed-circuit board connector - MCV 1,5/18-G-3,81 - 1844906



PCB headers, nominal current: 8 A, rated voltage (III/2): 160 V, nominal cross section: 1.5 mm², number of positions: 18, pitch: 3.81 mm, color: green, contact surface: Tin, mounting: Wave soldering, pin layout: Linear pinning, solder pin [P]: 3.4 mm

Phoenix Contact 2020 © - all rights reserved
<http://www.phoenixcontact.com>

PHOENIX CONTACT GmbH & Co. KG
Flachsmarktstr. 8
32825 Blomberg
Germany
Tel. +49 5235 300
Fax +49 5235 3 41200
<http://www.phoenixcontact.com>

Mouser Electronics

Authorized Distributor

Click to View Pricing, Inventory, Delivery & Lifecycle Information:

[Phoenix Contact:](#)

[1748134](#)