

# PCB terminal block - SMKDSP 1,5/ 2 - 1733415

Please be informed that the data shown in this PDF Document is generated from our Online Catalog. Please find the complete data in the user's documentation. Our General Terms of Use for Downloads are valid (<http://phoenixcontact.com/download>)

PCB terminal block, nominal current: 17.5 A, rated voltage (III/2): 400 V, nominal cross section: 1.5 mm<sup>2</sup>, pitch: 5 mm, number of positions: 2, connection method: Screw connection with tension sleeve, mounting: Wave soldering, conductor/PCB connection direction: 55 °, color: green, Pin layout: Linear pinning, Solder pin [P]: 3.5 mm. The article can be aligned to create different nos. of positions!

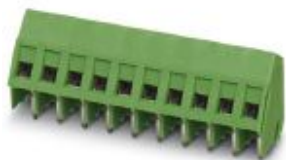

The figure shows a 10-position version of the product

## Your advantages

- Well-known connection principle allows worldwide use
- Low temperature rise, thanks to maximum contact force
- Allows connection of two conductors
- Angled connection enables multi-row arrangement on the PCB
- Quick and convenient testing using integrated test option
- The latching on the side enables various numbers of positions to be combined

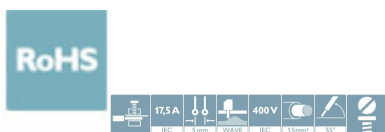

## Key Commercial Data

Packing unit	250 pc
GTIN	 4 017918 026554
GTIN	4017918026554

## Technical data

### Item properties

Brief article description	PCB terminal block
Range of articles	SMKDSP 1,5
Pitch	5 mm
Number of positions	2
Connection method	Screw connection with tension sleeve
Drive form screw head	Slotted (L)
Screw thread	M3
Mounting type	Wave soldering
Pin layout	Linear pinning

# PCB terminal block - SMKDSP 1,5/ 2 - 1733415

## Technical data

### Item properties

Number of levels	1
Number of connections	2
Number of potentials	2

### Electrical parameters

Nominal current	17.5 A
Nom. voltage	400 V
Rated voltage	250 V
Rated voltage (III/2)	400 V
Rated voltage (II/2)	630 V
Rated surge voltage (III/3)	4 kV
Rated surge voltage (III/2)	4 kV
Rated surge voltage (II/2)	4 kV

### Connection capacity

Connection method	Screw connection with tension sleeve
pluggable	no
Conductor cross section solid	0.14 mm <sup>2</sup> ... 2.5 mm <sup>2</sup>
Conductor cross section flexible	0.14 mm <sup>2</sup> ... 1.5 mm <sup>2</sup>
Conductor cross section AWG / kcmil	26 ... 14
Conductor cross section flexible, with ferrule without plastic sleeve	0.25 mm <sup>2</sup> ... 1.5 mm <sup>2</sup>
Conductor cross section, flexible, with ferrule, with plastic sleeve	0.25 mm <sup>2</sup> ... 1.5 mm <sup>2</sup>
2 conductors with same cross section, solid	0.14 mm <sup>2</sup> ... 1 mm <sup>2</sup>
2 conductors with same cross section, flexible	0.14 mm <sup>2</sup> ... 0.75 mm <sup>2</sup>
2 conductors with same cross section, flexible, with ferrule without plastic sleeve	0.25 mm <sup>2</sup> ... 0.5 mm <sup>2</sup>
2 conductors with the same cross section, flexible, with TWIN ferrule with plastic sleeve	0.5 mm <sup>2</sup> ... 1 mm <sup>2</sup>
Stripping length	7 mm
Torque	0.5 Nm ... 0.6 Nm

### Material data - contact

Note	WEEE/RoHS-compliant, free of whiskers according to IEC 60068-2-82/ JEDEC JESD 201
Contact material	Cu alloy
Surface characteristics	Tin-plated
Metal surface terminal point (top layer)	Tin (5 - 7 µm Sn)
Metal surface terminal point (middle layer)	Nickel (2 - 3 µm Ni)
Metal surface soldering area (top layer)	Tin (5 - 7 µm Sn)
Metal surface soldering area (middle layer)	Nickel (2 - 3 µm Ni)

### Material data - housing

Housing color	green (6021)
Insulating material	PA

# PCB terminal block - SMKDSP 1,5/ 2 - 1733415

## Technical data

### Material data - housing

Insulating material group	I
CTI according to IEC 60112	600
Flammability rating according to UL 94	V0
Glow wire flammability index GWFI according to EN 60695-2-12	850
Glow wire ignition temperature GWIT according to EN 60695-2-13	775
Temperature for the ball pressure test according to EN 60695-10-2	125 °C

### Dimensions for the product

Length [ l ]	13.4 mm
Width [ w ]	10 mm
Height [ h ]	18.6 mm
Pitch	5 mm
Height (without solder pin)	15.3 mm
Solder pin [P]	3.5 mm
Pin dimensions	0.9 x 0.9 mm

### Dimensions for PCB design

Hole diameter	1.3 mm
---------------	--------

### Packaging information

Type of packaging	packed in cardboard
Pieces per package	250
Denomination packing units	Pcs.

### General product information

Type of note	Note on application
Note	For safe conductor connection, always adhere to a defined tightening torque. Particularly in the case of PCB terminal blocks with two or three positions, the individual solder pin for each contact point cannot compensate for this. That is why the terminal blocks must be supported during conductor connection (held with one hand, support on the housing).

### Processing notes

Process	Wave soldering
Specification	Following IEC 61760-1:2006-04
	Following IEC 60068-2-54:2006-04

### Ambient conditions

Ambient temperature (storage/transport)	-40 °C ... 70 °C
Ambient temperature (assembly)	-5 °C ... 100 °C
Ambient temperature (operation)	-40 °C ... 100 °C (Depending on the current carrying capacity/derating curve)

### Termination and connection method

Test for conductor damage and slackening	IEC 60999-1:1990-05
	Test passed

# PCB terminal block - SMKDSP 1,5/ 2 - 1733415

## Technical data

### Pull-out test

Pull-out test	IEC 60999-1:1990-05
	Test passed
Conductor cross section / conductor type / tensile force	0.14 mm <sup>2</sup> / solid / > 7 N
	0.14 mm <sup>2</sup> / flexible / > 7 N
	2.5 mm <sup>2</sup> / solid / > 50 N
	1.5 mm <sup>2</sup> / flexible / > 40 N

### Mechanical tests according to standard

Test specification	IEC 60999-1 (in parts)
--------------------	------------------------

### Electrical tests

Rated current	17.5 A
Conductor cross section	1.5 mm <sup>2</sup>
Rated voltage (III/2)	400 V
Rated surge voltage (III/2)	4 kV

### Air clearances and creepage distances

Clearances and creepage distances	IEC 60664-1:2007-04
Specification	IEC 60664-1:2007-04
Minimum clearance - inhomogeneous field (III/3)	3 mm
Minimum clearance - inhomogeneous field (III/2)	3 mm
Minimum clearance - inhomogeneous field (II/2)	3 mm
Minimum creepage distance value (III/3)	3.2 mm
Minimum creepage distance value (III/2)	2 mm
Minimum creepage distance value (II/2)	3.2 mm

### Vibration test

Specification	IEC 60068-2-6:1982 + AMD 2:1985
Result	Test passed
Frequency	10 - 150 - 10 Hz
Sweep speed	1 octave/min
Amplitude	0.35 mm (10 - 60.1 Hz)
Acceleration	5 g (60.1 - 150 Hz)
Test duration per axis	2.5 h

### Insulation resistance

Specification	IEC 60512-2:1985-00
Result	Test passed
Insulation resistance, neighboring positions	10 <sup>12</sup> Ω

### Standards and Regulations

Connection in acc. with standard	EN-VDE
	CSA
Flammability rating according to UL 94	V0

# PCB terminal block - SMKDSP 1,5/ 2 - 1733415

## Technical data

### Environmental Product Compliance

REACH SVHC	Lead 7439-92-1
China RoHS	Environmentally Friendly Use Period = 50 years
	For details about hazardous substances go to tab "Downloads", Category "Manufacturer's declaration"

## Drawings

Drilling diagram

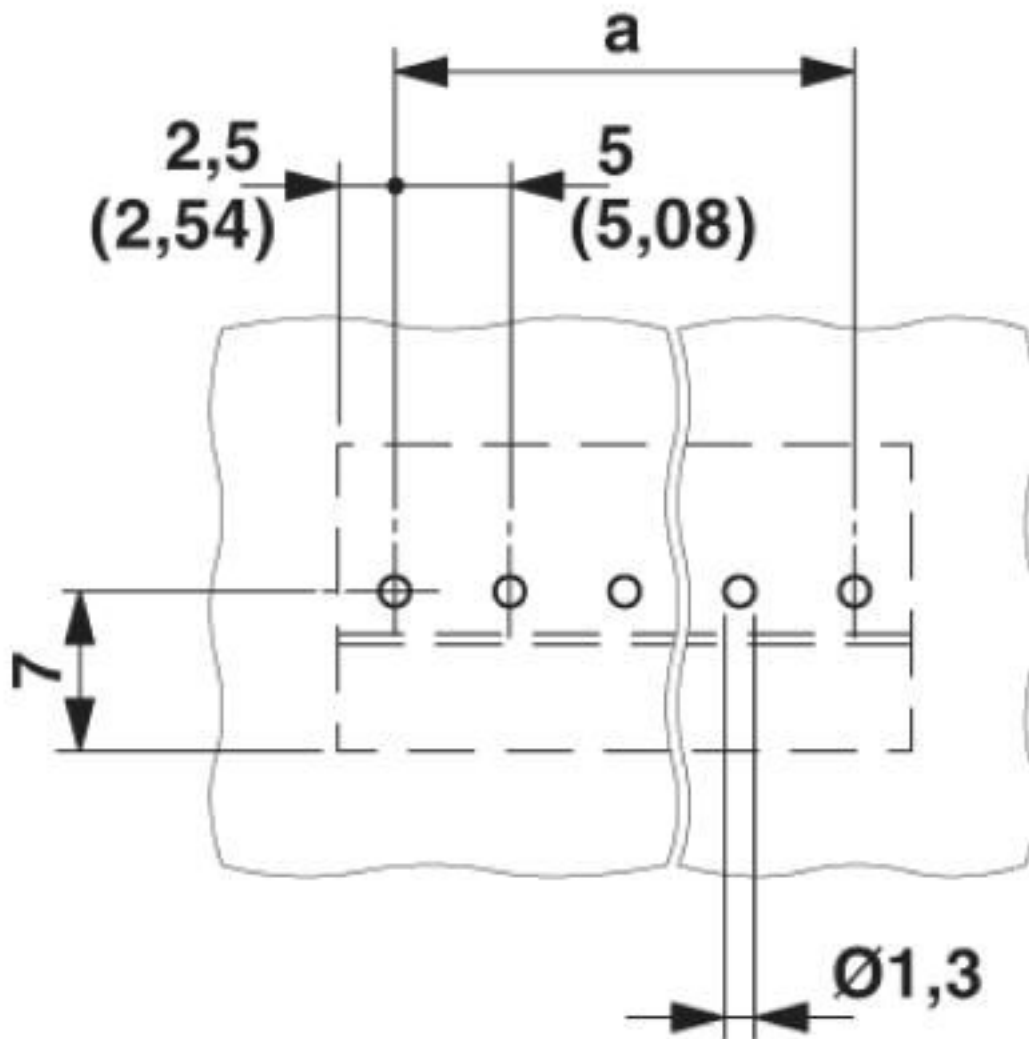

# PCB terminal block - SMKDSP 1,5/ 2 - 1733415

Dimensional drawing

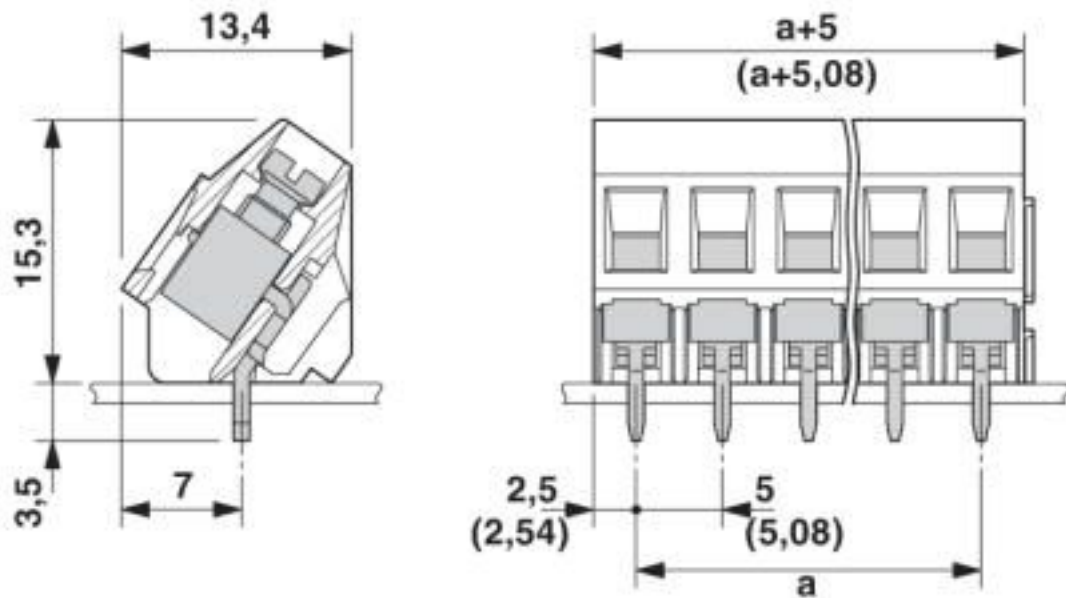

## Classifications

### eCl@ss

eCl@ss 10.0.1	27440401
eCl@ss 4.0	27141100
eCl@ss 4.1	27141100
eCl@ss 5.0	27141100
eCl@ss 5.1	27261100
eCl@ss 6.0	27261100
eCl@ss 7.0	27440401
eCl@ss 8.0	27440401
eCl@ss 9.0	27440401

### ETIM

ETIM 3.0	EC001121
ETIM 4.0	EC002643
ETIM 5.0	EC002643
ETIM 6.0	EC002643
ETIM 7.0	EC002643

### UNSPSC

UNSPSC 6.01	30211801
UNSPSC 7.0901	39121432
UNSPSC 11	39121432
UNSPSC 12.01	39121432
UNSPSC 13.2	39121432

# PCB terminal block - SMKDSP 1,5/ 2 - 1733415

## Classifications

### UNSPSC

UNSPSC 18.0	39121432
UNSPSC 19.0	39121432
UNSPSC 20.0	39121432
UNSPSC 21.0	39121432

## Approvals

### Approvals

#### Approvals

CSA / IECCEB Scheme / SEV / EAC / cULus Recognized

#### Ex Approvals

### Approval details

CSA		<a href="http://www.csagroup.org/services-industries/product-listing/">http://www.csagroup.org/services-industries/product-listing/</a>	13631
		B	D
Nominal voltage UN		300 V	300 V
Nominal current IN		10 A	10 A
mm <sup>2</sup> /AWG/kcmil		28-14	28-14

IECEE CB Scheme		<a href="http://www.iecee.org/">http://www.iecee.org/</a>	CH-10724-A1
Nominal voltage UN		250 V	
Nominal current IN		22 A	
mm <sup>2</sup> /AWG/kcmil		2.5	

SEV		<a href="https://www.eurofins.ch/de/">https://www.eurofins.ch/de/</a>	IK-4486-A1
Nominal voltage UN		250 V	
Nominal current IN		22 A	
mm <sup>2</sup> /AWG/kcmil		2.5	

# PCB terminal block - SMKDSP 1,5/ 2 - 1733415

## Approvals

EAC		B.01687
-----	--	---------

cULus Recognized		<a href="http://database.ul.com/cgi-bin/XYV/template/LISEXT/1FRAME/index.htm">http://database.ul.com/cgi-bin/XYV/template/LISEXT/1FRAME/index.htm</a>	E60425-19870331
	B	D	
Nominal voltage UN	250 V	300 V	
Nominal current IN	15 A	10 A	
mm <sup>2</sup> /AWG/kcmil	30-14	30-14	

## Accessories

### Accessories

#### Labeled terminal marker

Marker card - SK 5/3,8:FORTL.ZAHLEN - 0804183



Marker card, Card, white, labeled, horizontal: consecutive numbers 1 ... 10, 11 ... 20, etc. up to 91 ... (99)100, mounting type: adhesive, for terminal block width: 5 mm, lettering field size: 5 x 3.8 mm

### Screwdriver tools

Screwdriver - SZS 0,6X3,5 - 1205053



Actuation tool, for ST terminal blocks, insulated, also suitable for use as a bladed screwdriver, size: 0.6 x 3.5 x 100 mm, 2-component grip, with non-slip grip

### Test plug terminal block

Test plugs - MPS-MT - 0201744



Test plugs, with solder connection up to 1 mm<sup>2</sup> conductor cross section, color: gray



## PCB terminal block - SMKDSP 1,5/ 2 - 1733415

### Accessories

Reducing plug - RPS - 0201647



Reducing plug, color: gray

---

Phoenix Contact 2020 © - all rights reserved  
<http://www.phoenixcontact.com>

PHOENIX CONTACT GmbH & Co. KG  
Flachsmarktstr. 8  
32825 Blomberg  
Germany  
Tel. +49 5235 300  
Fax +49 5235 3 41200  
<http://www.phoenixcontact.com>

# Mouser Electronics

Authorized Distributor

Click to View Pricing, Inventory, Delivery & Lifecycle Information:

[Phoenix Contact:](#)

[1733415](#)