

Plug - PTDA 2,5/ 6-PH-5,0 - 1725549

Please be informed that the data shown in this PDF Document is generated from our Online Catalog. Please find the complete data in the user's documentation. Our General Terms of Use for Downloads are valid (<http://phoenixcontact.com/download>)

PCB connector, nominal current: 14 A, rated voltage (III/2): 400 V, nominal cross section: 2.5 mm², number of positions: 6, pitch: 5 mm, connection method: Push-in spring connection, color: green, contact surface: Tin



The figure shows a 10-position version of the product

Your advantages

- Time saving push-in connection, tools not required
- Defined contact force ensures that contact remains stable over the long term
- Potentials can be easily looped through – ideal for BUS applications
- Quick and convenient testing using integrated test option
- Rounded type for individual device design



Key Commercial Data

Packing unit	100 pc
GTIN	 4 046356 129794
GTIN	4046356129794

Technical data

Item properties

Brief article description	PCB connector
Plug-in system	COMBICON COMPACT PST 1,3
Type of contact	Female connector
Range of articles	PTDA 2,5/...-PH
Pitch	5 mm
Number of positions	6
Connection method	Push-in spring connection
Locking	without
Number of levels	1
Number of connections	12

Plug - PTDA 2,5/ 6-PH-5,0 - 1725549

Technical data

Item properties

Number of potentials	6
----------------------	---

Electrical parameters

Nominal current	13.5 A
Nom. voltage	400 V
Rated voltage	320 V
Rated voltage (III/2)	400 V
Rated voltage (II/2)	630 V
Rated surge voltage (III/3)	4 kV
Rated surge voltage (III/2)	4 kV
Rated surge voltage (II/2)	4 kV

Connection capacity

Connection method	Push-in spring connection
pluggable	Yes
Conductor cross section solid	0.2 mm ² ... 2.5 mm ²
Conductor cross section flexible	0.2 mm ² ... 2.5 mm ²
Conductor cross section AWG / kcmil	24 ... 14
Conductor cross section flexible, with ferrule without plastic sleeve	0.5 mm ² ... 2.5 mm ²
Conductor cross section, flexible, with ferrule, with plastic sleeve	0.5 mm ² ... 1 mm ²
2 conductors with same cross section, solid	0.2 mm ² ... 2.5 mm ²
2 conductors with same cross section, flexible	0.2 mm ² ... 2.5 mm ²
2 conductors with same cross section, flexible, with ferrule without plastic sleeve	0.5 mm ² ... 2.5 mm ²
2 conductors with the same cross section, flexible, with TWIN ferrule with plastic sleeve	0.5 mm ² ... 1 mm ²
Stripping length	10 mm

Material data - contact

Note	WEEE/RoHS-compliant, free of whiskers according to IEC 60068-2-82/ JEDEC JESD 201
Contact material	Cu alloy
Metal surface terminal point (top layer)	Tin (4 - 8 µm Sn)
Metal surface contact area (top layer)	Tin (4 - 8 µm Sn)

Material data - housing

Housing color	green (6021)
Insulating material	PA
Insulating material group	I
CTI according to IEC 60112	600
Flammability rating according to UL 94	V0
Glow wire flammability index GWFI according to EN 60695-2-12	850
Glow wire ignition temperature GWIT according to EN 60695-2-13	775
Temperature for the ball pressure test according to EN 60695-10-2	125 °C

Plug - PTDA 2,5/ 6-PH-5,0 - 1725549

Technical data

Dimensions for the product

Length [l]	20 mm
Width [w]	31.4 mm
Height [h]	16 mm
Pitch	5 mm
Height (without solder pin)	16 mm

Packaging information

Type of packaging	packed in cardboard
Pieces per package	100
Denomination packing units	Pcs.

Environmental Product Compliance

China RoHS	Environmentally friendly use period: unlimited = EFUP-e
	No hazardous substances above threshold values

Drawings

Diagram

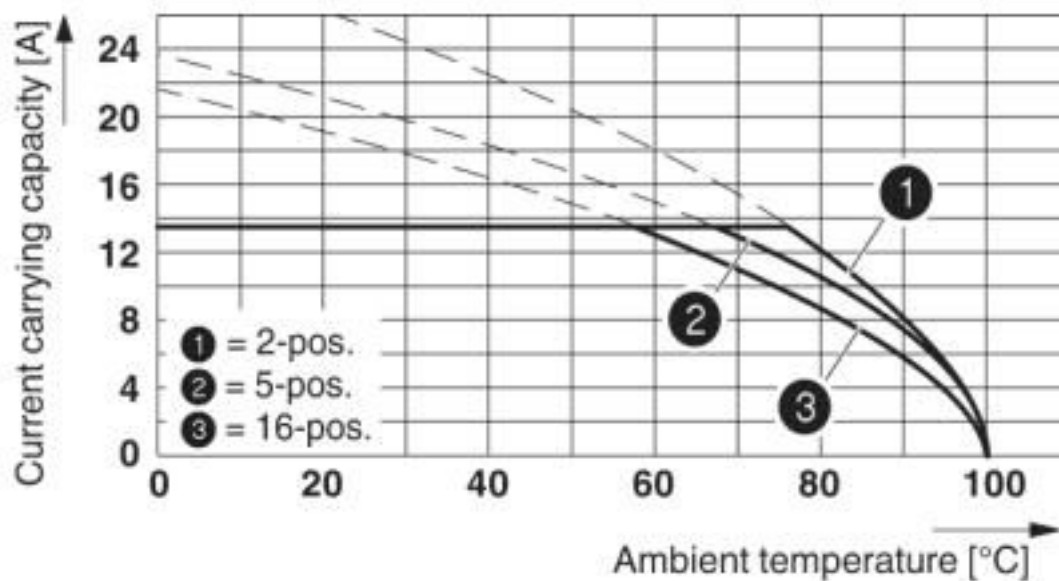

Plug - PTDA 2,5/ 6-PH-5,0 - 1725549

Diagram

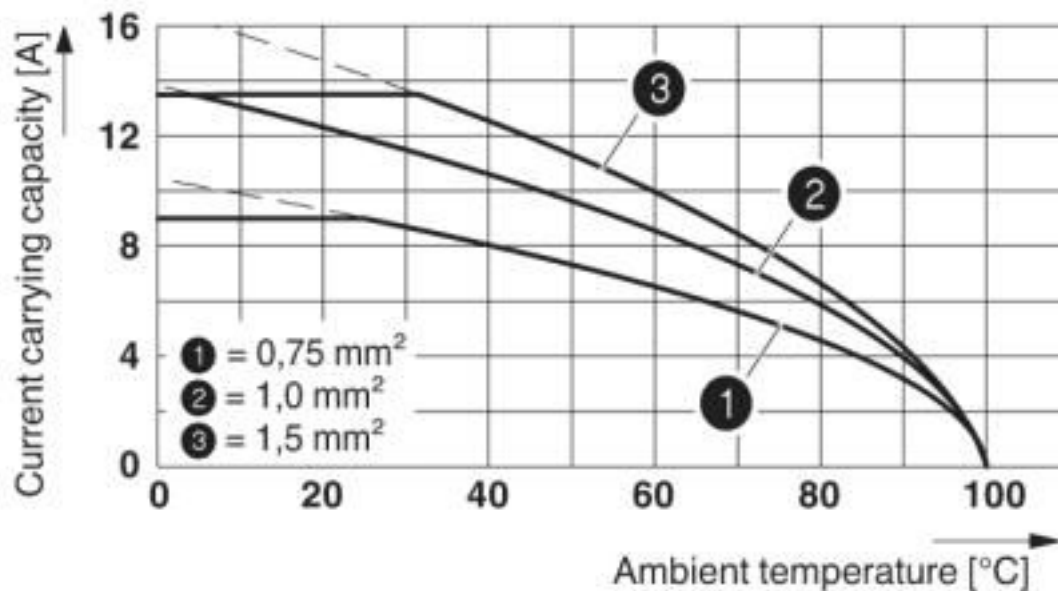

Dimensional drawing

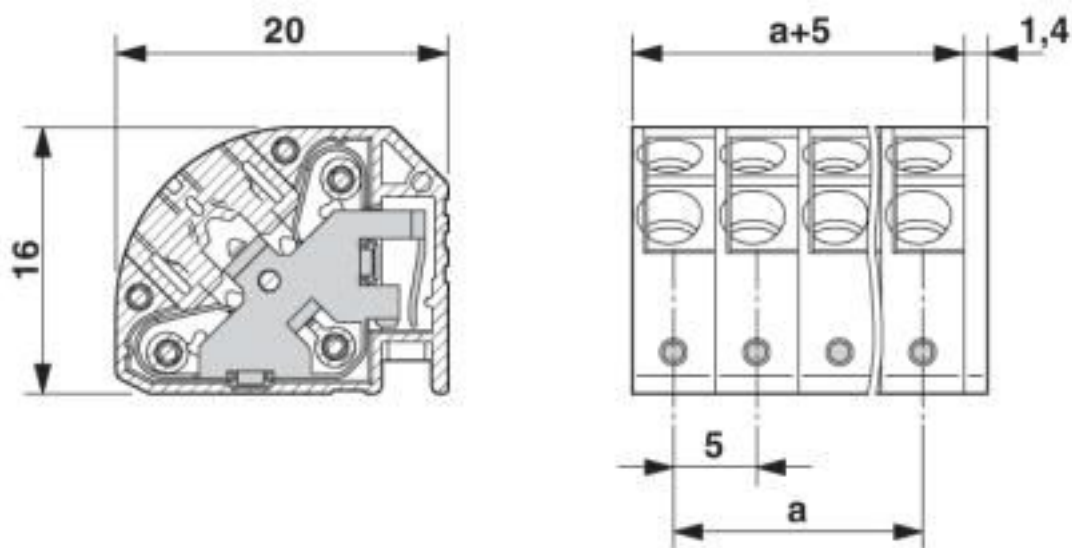

Classifications

eCl@ss

eCl@ss 10.0.1	27440309
eCl@ss 4.0	27260700
eCl@ss 4.1	27260700
eCl@ss 5.0	27260700
eCl@ss 5.1	27260700
eCl@ss 6.0	27260700

Plug - PTDA 2,5/ 6-PH-5,0 - 1725549

Classifications

eCl@ss

eCl@ss 7.0	27440309
eCl@ss 8.0	27440309
eCl@ss 9.0	27440309

ETIM

ETIM 3.0	EC001121
ETIM 4.0	EC002638
ETIM 5.0	EC002638
ETIM 6.0	EC002638
ETIM 7.0	EC002638

UNSPSC

UNSPSC 6.01	30211801
UNSPSC 7.0901	39121432
UNSPSC 11	34131203
UNSPSC 12.01	39121432
UNSPSC 13.2	39121409
UNSPSC 18.0	39121409
UNSPSC 19.0	39121409
UNSPSC 20.0	39121409
UNSPSC 21.0	39121409

Approvals

Approvals

Approvals

EAC / cULus Recognized

Ex Approvals

Approval details

EAC		B.01687
-----	---	---------

Plug - PTDA 2,5/ 6-PH-5,0 - 1725549

Approvals

cULus Recognized		http://database.ul.com/cgi-bin/XYV/template/LISEXT/1FRAME/index.htm E60425-20030211	
	B	C	D
Nominal voltage UN	300 V	150 V	300 V
Nominal current IN	13.5 A	13.5 A	10 A
mm ² /AWG/kcmil	24-14	24-14	24-14

Accessories

Additional products

Pin strip - PST 1,3/ 6-H-5,0 - 1705504



Pin strip, nominal current: 12 A, rated voltage (III/2): 320 V, nominal cross section: 1.5 mm², number of positions: 6, pitch: 5 mm, color: black, contact surface: Tin, mounting: THR soldering, pin layout: Linear pinning, solder pin [P]: 6.8 mm, The maximum current depends on the plug used. The lower of the two current values apply for plug and pin strip. The pin strip is made of highly temperature resistant plastic and is thus suitable for the reflow process.

Pin strip - PST 1,3/ 6-5,0 R56 - 1720330



Pin strip, nominal current: 12 A, rated voltage (III/2): 320 V, nominal cross section: 1.5 mm², number of positions: 6, pitch: 5 mm, color: black, contact surface: Tin, mounting: THR soldering, pin layout: Linear pinning, solder pin [P]: 3.5 mm, The maximum current depends on the plug used. The lower of the two current values apply for plug and pin strip. The pin strip is made of highly temperature resistant plastic and is thus suitable for the reflow process.

Pin strip - PST 1,3/ 6-5,0 - 1933228



Pin strip, nominal current: 12 A, rated voltage (III/2): 320 V, nominal cross section: 1.5 mm², number of positions: 6, pitch: 5 mm, color: black, contact surface: Tin, mounting: THR soldering, pin layout: Linear pinning, solder pin [P]: 3.5 mm, The maximum current depends on the plug used. The lower of the two current values apply for plug and pin strip. The pin strip is made of highly temperature resistant plastic and is thus suitable for the reflow process.

Screwdriver - SZF 1-0,6X3,5 - 1204517



Actuation tool, for ST terminal blocks, also suitable for use as a bladed screwdriver, size: 0.6 x 3.5 x 100 mm, 2-component grip, with non-slip grip

Plug - PTDA 2,5/ 6-PH-5,0 - 1725549

Accessories

Coding profile - CP-PTDA - 1731361

Coding profile, inserted into the groove on the plug, made from red insulating material, diameter: 1.35 mm



Phoenix Contact 2020 © - all rights reserved
<http://www.phoenixcontact.com>

PHOENIX CONTACT GmbH & Co. KG
Flachsmarktstr. 8
32825 Blomberg
Germany
Tel. +49 5235 300
Fax +49 5235 3 41200
<http://www.phoenixcontact.com>

Mouser Electronics

Authorized Distributor

Click to View Pricing, Inventory, Delivery & Lifecycle Information:

[Phoenix Contact:](#)

[1725549](#)