

# Contact insert - HC-K 6/36-EBUC - 1636389

Please be informed that the data shown in this PDF Document is generated from our Online Catalog. Please find the complete data in the user's documentation. Our General Terms of Use for Downloads are valid (<http://phoenixcontact.com/download>)



HEAVYCON female insert, K6/36 series, for 6 power and 36 control contacts, crimp connection



## Key Commercial Data

Packing unit	1 pc
GTIN	 4 046356 011525
GTIN	4046356011525

## Technical data

### General

Note	For HEAVYCON ADVANCE and HEAVYCON housing of type B16/B32, power contacts: CK 4,0-ED, control contacts: CK 1,6-ED (crimp contacts not supplied as standard)
	Connectors may be operated only when there is no load/voltage.
Connection method	Crimp connection (power contacts)
	Crimp connection (control contacts)
Torque	0.8 Nm ... 1.2 Nm (PE connection)
	0.5 Nm ... 0.8 Nm (Mounting screws for mounting in the HEAVYCON housing)
Degree of pollution	3
Overvoltage category	III
Number of positions	6+36+PE
No. of power contacts	6
No. of control contacts	36
Insertion/withdrawal cycles	≥ 500
Size	B16
	B32
Contact numbering	1 - 6

# Contact insert - HC-K 6/36-EBUC - 1636389

## Technical data

### General

Conductor cross section	1.5 mm <sup>2</sup> ... 6 mm <sup>2</sup> (power contacts)
	0.14 mm <sup>2</sup> ... 2.5 mm <sup>2</sup> (control contacts)
Connection cross section AWG	16 ... 10 (power contacts)
	26 ... 14 (control contacts)
Stripping length of the individual wire	9 mm (1.5 mm <sup>2</sup> ... 2.5 mm <sup>2</sup> )
	8 mm (0.14 ... 1.5 mm <sup>2</sup> )
	9.5 mm (4 mm <sup>2</sup> ... 6 mm <sup>2</sup> )
	6 mm (2.5 mm <sup>2</sup> )
Wire diameter including insulation	5 mm
Assembly instructions	To ensure correct use, installation in housing with IP54 protection or better is required

### Ambient conditions

Ambient temperature (operation)	-40 °C ... 125 °C
---------------------------------	-------------------

### Material data

Contact material	Cu alloy
Material of contact surface, power contact	Ag
Material of contact surface, control contact	Ag (alternatively Au)
Contact carrier material	PC

### Electrical characteristics

Rated voltage (III/3)	690 V (power contacts)
	160 V (control contacts)
Rated surge voltage	8 kV (power contacts)
	2.5 kV (control contacts)
Rated current	40 A (power contacts)
	10 A (control contacts)

### Standards and Regulations

Connection in acc. with standard	CSA
Flammability rating according to UL 94	V0

### Environmental Product Compliance

China RoHS	Environmentally friendly use period: unlimited = EFUP-e
	No hazardous substances above threshold values

## Drawings

# Contact insert - HC-K 6/36-EBUC - 1636389

Schematic diagram

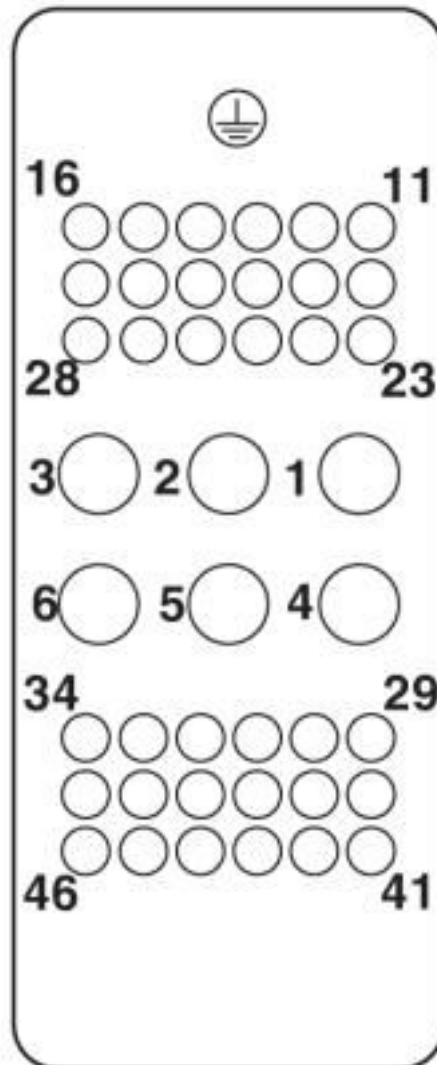

Connector pin assignment, connection side

# Contact insert - HC-K 6/36-EBUC - 1636389

Diagram

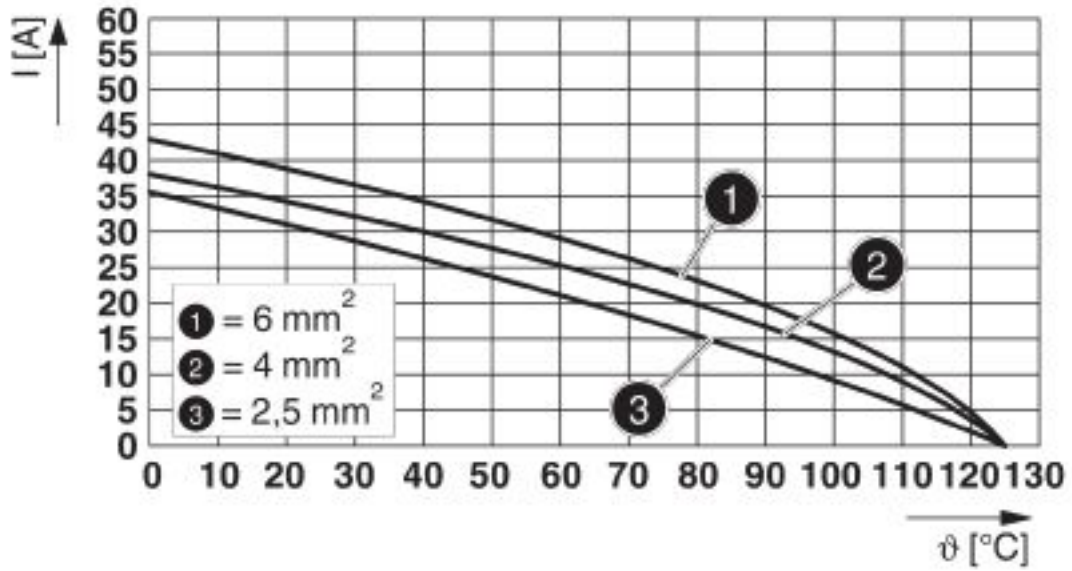

Derating diagram

Dimensional drawing

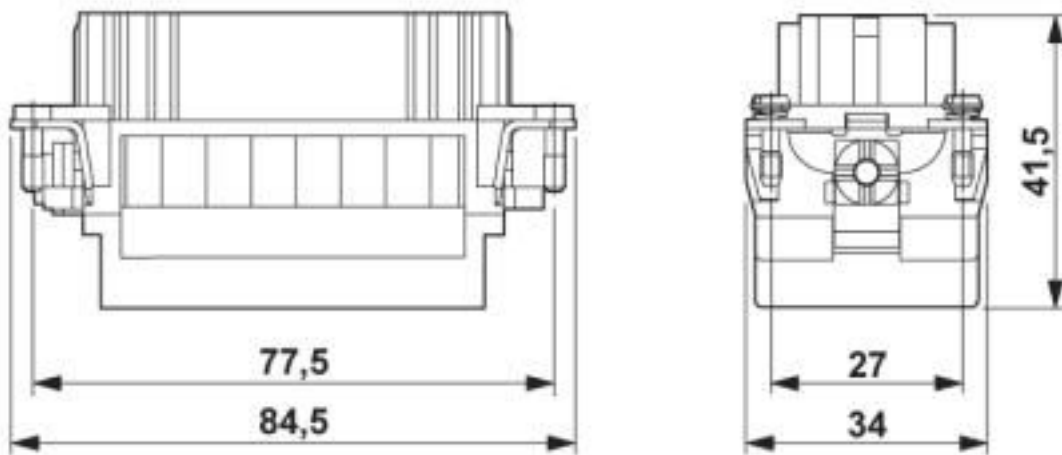

Dimensional drawing

# Contact insert - HC-K 6/36-EBUC - 1636389

Dimensional drawing

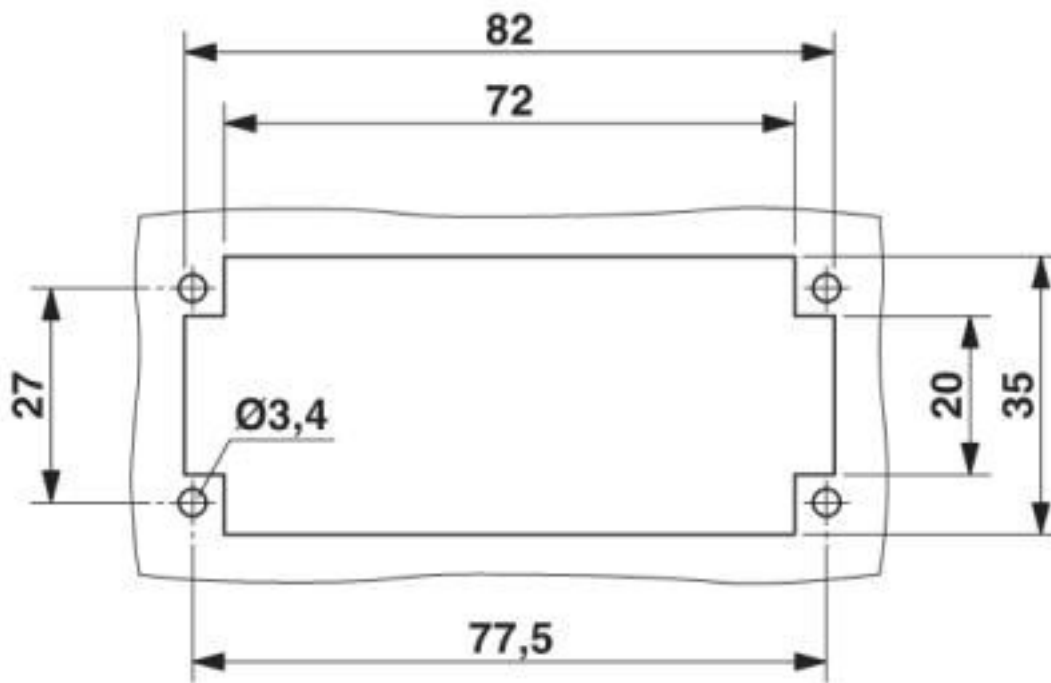

Mounting cutout when used without housing

## Classifications

eCl@ss

eCl@ss 10.0.1	27440205
eCl@ss 4.0	27140800
eCl@ss 4.1	27140800
eCl@ss 5.0	27143400
eCl@ss 5.1	27261200
eCl@ss 6.0	27261200
eCl@ss 7.0	27440205
eCl@ss 8.0	27440205
eCl@ss 9.0	27440205

ETIM

ETIM 2.0	EC000438
ETIM 3.0	EC000438
ETIM 4.0	EC000438
ETIM 5.0	EC000438
ETIM 6.0	EC000438
ETIM 7.0	EC000438

# Contact insert - HC-K 6/36-EBUC - 1636389

## Classifications

### UNSPSC

UNSPSC 6.01	30211923
UNSPSC 7.0901	39121522
UNSPSC 11	39121522
UNSPSC 12.01	39121522
UNSPSC 13.2	39121522
UNSPSC 18.0	39121522
UNSPSC 19.0	39121522
UNSPSC 20.0	39121522
UNSPSC 21.0	39121522

## Approvals

### Approvals

Approvals

EAC / UL Recognized

Ex Approvals

### Approval details

EAC		RU C- DE.BL08.B.00511
-----	---	--------------------------

UL Recognized		<a href="http://database.ul.com/cgi-bin/XYV/template/LISEXT/1FRAME/index.htm">http://database.ul.com/cgi-bin/XYV/template/LISEXT/1FRAME/index.htm</a>	E118976
Nominal voltage UN	600 V		
Nominal current IN	10 A		
mm <sup>2</sup> /AWG/kcmil	14		

## Accessories

Accessories

Coding element

## Contact insert - HC-K 6/36-EBUC - 1636389

### Accessories

Coding element - HC-CST - 1676857



Coding peg for coding up to 16 connectors

---

Coding element - HC-CBU - 1676860



Coding socket for coding up to 16 connectors

---

Coding bolt - HC-CB - 1772722



Coding pin, prevents mismatching of up to six connectors with an identical number of positions

---

### Crimp contact

Crimp contact - CK1,6-ED-0,37BU AG - 1663394



Turned 1.6 crimp contact, individual female contact, core diameter 0.14 to 0.37 mm<sup>2</sup>, silver-plated

---

Crimp contact - CK1,6-ED-0,50BU AG - 1663404



Turned 1.6 crimp contact, individual female contact, core diameter 0.5 mm<sup>2</sup>, silver-plated

---

## Contact insert - HC-K 6/36-EBUC - 1636389

### Accessories

Crimp contact - CK1,6-ED-0,75BU AG - 1663417



Turned 1.6 crimp contact, individual female contact, core diameter 0.75 mm<sup>2</sup>, silver-plated

---

Crimp contact - CK1,6-ED-1,00BU AG - 1663420



Turned 1.6 crimp contact, individual female contact, core diameter 0.75 to 1.00 mm<sup>2</sup>, silver-plated

---

Crimp contact - CK1,6-ED-1,50BU AG - 1663433



Turned 1.6 crimp contact, individual female contact, core diameter 1.5 mm<sup>2</sup>, silver-plated

---

Crimp contact - CK1,6-ED-2,50BU AG - 1663446



Turned 1.6 crimp contact, individual female contact, core diameter 2.5 mm<sup>2</sup>, silver-plated

---

Crimp contact - CK1,6-ED-0,37BU AU - 1674969



Turned 1.6 crimp contact, individual female contact, core diameter 0.14 to 0.37 mm<sup>2</sup>, gold-plated

---



## Contact insert - HC-K 6/36-EBUC - 1636389

### Accessories

Crimp contact - CK1,6-ED-0,50BU AU - 1674480



Turned 1.6 crimp contact, individual female contact, core diameter 0.5 mm<sup>2</sup>, gold-plated

---

Crimp contact - CK1,6-ED-0,75BU AU - 1672440



Turned 1.6 crimp contact, individual female contact, core diameter 0.75 mm<sup>2</sup>, gold-plated

---

Crimp contact - CK1,6-ED-1,00BU AU - 1674943



Turned 1.6 crimp contact, individual female contact, core diameter 0.75 to 1.00 mm<sup>2</sup>, gold-plated

---

Crimp contact - CK1,6-ED-1,50BU AU - 1674930



Turned 1.6 crimp contact, individual female contact, core diameter 1.5 mm<sup>2</sup>, gold-plated

---

Crimp contact - CK1,6-ED-2,50BU AU - 1674985



Turned 1.6 crimp contact, individual female contact, core diameter 2.5 mm<sup>2</sup>, gold-plated

---

## Contact insert - HC-K 6/36-EBUC - 1636389

### Accessories

Crimp contact - CK4,0-ED-1,50BU AG - 1663271



Turned 4.0 crimp contact, individual female contact, core diameter 1.50 mm<sup>2</sup>, silver-plated

---

Crimp contact - CK4,0-ED-2,50BU AG - 1663284



Turned 4.0 crimp contact, individual female contact, core diameter 2.50 mm<sup>2</sup>, silver-plated

---

Crimp contact - CK4,0-ED-4,00BU AG - 1663297



Turned 4.0 crimp contact, individual female contact, core diameter 4.00 mm<sup>2</sup>, silver-plated

---

Crimp contact - CK4,0-ED-6,00BU AG - 1663307



Turned 4.0 crimp contact, individual female contact, core diameter 6.00 mm<sup>2</sup>, silver-plated

---

Crimp contact - CK4,0-ED-10,00BU AG - 1586183



Turned 4.0 crimp contact, single socket contact, 10 mm<sup>2</sup> conductor cross section, silver-plated

---

### Fiber optics contact

## Contact insert - HC-K 6/36-EBUC - 1636389

### Accessories

Female contact - CK1,6-ED-BU-POF - 1885004



POF fiber optic socket contact, turned, for contact carriers (HC-DD...I-CT.../ HC-M-12-CT-F.../ HC-M-17-CT-F...) of CK1,6-ED... contacts

---

### Additional products

Contact insert - HC-K 6/36-ESTC - 1636376



HEAVYCON male insert, K6/36 series, for 6 power and 36 control contacts, crimp connection

---

Phoenix Contact 2020 © - all rights reserved  
<http://www.phoenixcontact.com>

PHOENIX CONTACT GmbH & Co. KG  
Flachsmarktstr. 8  
32825 Blomberg  
Germany  
Tel. +49 5235 300  
Fax +49 5235 3 41200  
<http://www.phoenixcontact.com>

# Mouser Electronics

Authorized Distributor

Click to View Pricing, Inventory, Delivery & Lifecycle Information:

[Phoenix Contact:](#)

[1636389](#)