

AC charging cable - EV-TAG3PC-1AC20A-4,0M2,5EHBK01 - 1628025

Please be informed that the data shown in this PDF Document is generated from our Online Catalog. Please find the complete data in the user's documentation. Our General Terms of Use for Downloads are valid (<http://phoenixcontact.com/download>)



Mobile AC charging cable, with vehicle charging connector and infrastructure charging plug, with protective caps, Housing color black-gray, for charging electric vehicles (EV) with alternating current (AC) via type 1 vehicle charging inlets, compatible with type 2 infrastructure charging sockets at charging stations for electromobility (EVSE), Type 1, Type 2, IEC 62196-2, SAE J1772, 20 A / 250 V (AC), C-Line, "PHOENIX CONTACT" logo, cable: 4 m, black, spiraled

Product Description

Mobile AC charging cable with Vehicle Connector and Infrastructure Plug for charging electric vehicles (EV) with alternating current (AC), via type 1 Vehicle Inlets, compatible with type 2 Infrastructure Socket Outlets at charging stations for E-Mobility (EVSE)

Your advantages

- ✔ Consistent design of all Phoenix Contact Vehicle Connectors and Infrastructure Plugs
- ✔ Silver-plated surface of the power and signal contacts
- ✔ Certified in accordance with IATF 16949:2016 and ISO 9001:2015
- ✔ Convenient handling, thanks to the ergonomic handle and additional, rubber grip components
- ✔ Tested in accordance with selected tests of automotive standards LV124, LV214, LV215-2
- ✔ Reliable function of the locking lever with additional seal
- ✔ Consistent longitudinal water tightness prevents water ingress in the cable



Key Commercial Data

Packing unit	1 pc
GTIN	 4 055626 377377
GTIN	4055626377377

Technical data

Product definition

Type	Mobile AC charging cable
	with vehicle charging connector and infrastructure charging plug
	with protective caps
	Housing color black-gray
Application	for charging electric vehicles (EV) with alternating current (AC) via type 1 vehicle charging inlets

AC charging cable - EV-TAG3PC-1AC20A-4,0M2,5EHBK01 - 1628025

Technical data

Product definition

	compatible with type 2 infrastructure charging sockets at charging stations for electromobility (EVSE)
Affixed logo	"PHOENIX CONTACT" logo
Design	C-Line
Standards/regulations	IEC 62196-2
	SAE J1772
Charging standard	Type 1
	Type 2
Charging mode	Mode 3, Case B

Dimensions

Height	151.1 mm (Vehicle charging connector)
	131.8 mm (Infrastructure charging plug)
Width	58 mm (Vehicle charging connector)
	58 mm (Infrastructure charging plug)
Depth	236.1 mm (Vehicle charging connector)
	233.4 mm (Infrastructure charging plug)
Conductor length	4 m

Ambient conditions

Ambient temperature (operation)	-30 °C ... 50 °C
Ambient temperature (storage/transport)	-40 °C ... 80 °C
Max. altitude	5000 m (above sea level)
Degree of protection	IP44 (plugged in; when plugged in and ready to operate, the degree of protection is only ensued if both plug-in components are original products from Phoenix Contact or suitable standard-compliant products)
	IP54 (Protective cap)

Electrical properties

Maximum charging power	5 kW
Number of phases	1
Number of power contacts	3 (L1, N, PE)
Rated current of power contacts	20 A
Rated voltage for power contacts	250 V AC
Number of signal contacts	2 (CP, CS)
Rated current for signal contacts	2 A
Rated voltage for signal contacts	30 V AC
Type of signal transmission	Pulse width modulation
Note on the connection method	Crimp connection, cannot be disconnected
Resistor coding	480 Ω (Lever actuated)
	150 Ω (Lever not actuated)

Mechanical properties

Insertion/withdrawal cycles	> 10000
-----------------------------	---------

AC charging cable - EV-TAG3PC-1AC20A-4,0M2,5EHBK01 - 1628025

Technical data

Mechanical properties

Insertion force	< 75 N
Withdrawal force	< 75 N

Design

Design line	C-Line
Housing color	black
Mating face color	black
Color handle area	gray
Actuating element color	silver
Color protective cap	black
Customer variations	On request

Material

Housing material	Plastic
Material handle area	Soft plastic
Actuating lever material	Metal
Material protective cap	Soft plastic
Material mating face	Plastic
Flammability rating	V0
Material surface of contacts	Ag

Cable

Cable structure	3 x 2.5 mm ² + 1 x 0.5 mm ²
Wiring standards/regulations	prEN 50620 / DIN EN 50620
Wiring class	Class 5
Wiring certifications	VDE
External cable diameter	10.2 mm ±0.3 mm
Type of conductor	spiraled
Cable resistance	≤ 0.00798 Ω/m (based on a power core, at an ambient temperature of 20°C)
Outer sheath, material	TPE-U
External sheath, color	black
Minimum bending radius	153 mm (15 x diameter)
Coil diameter	45 mm ±10 %
Block length	0.68 m ±10 %
Effective length	max. 4 m ±5 %

Locking

Locking type	No locking option for U-lock
--------------	------------------------------

Environmental Product Compliance

REACH SVHC	Lead 7439-92-1
China RoHS	Environmentally Friendly Use Period = 10;

AC charging cable - EV-TAG3PC-1AC20A-4,0M2,5EHBK01 - 1628025

Technical data

Environmental Product Compliance

	For details about hazardous substances go to tab "Downloads", Category "Manufacturer's declaration"
--	---

Drawings

Schematic diagram

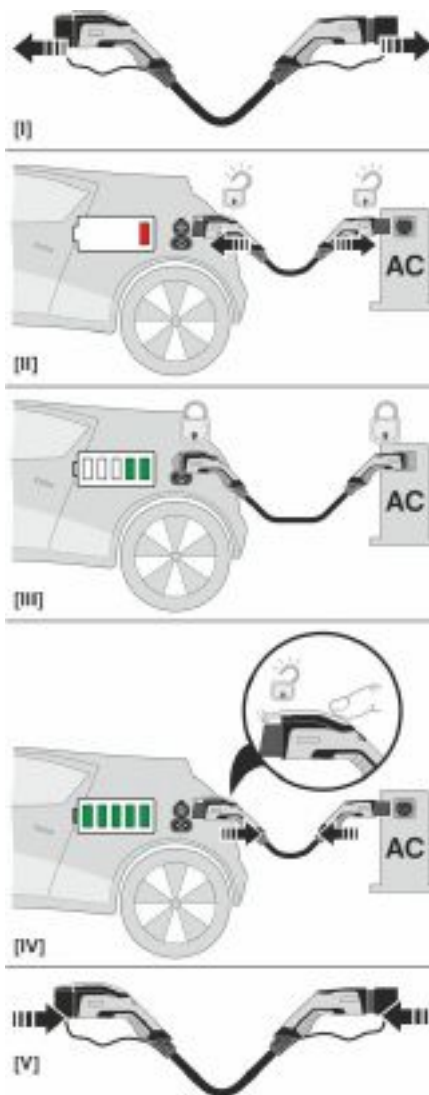

Operating instructions

AC charging cable - EV-TAG3PC-1AC20A-4,0M2,5EHBK01 - 1628025

Connection diagram

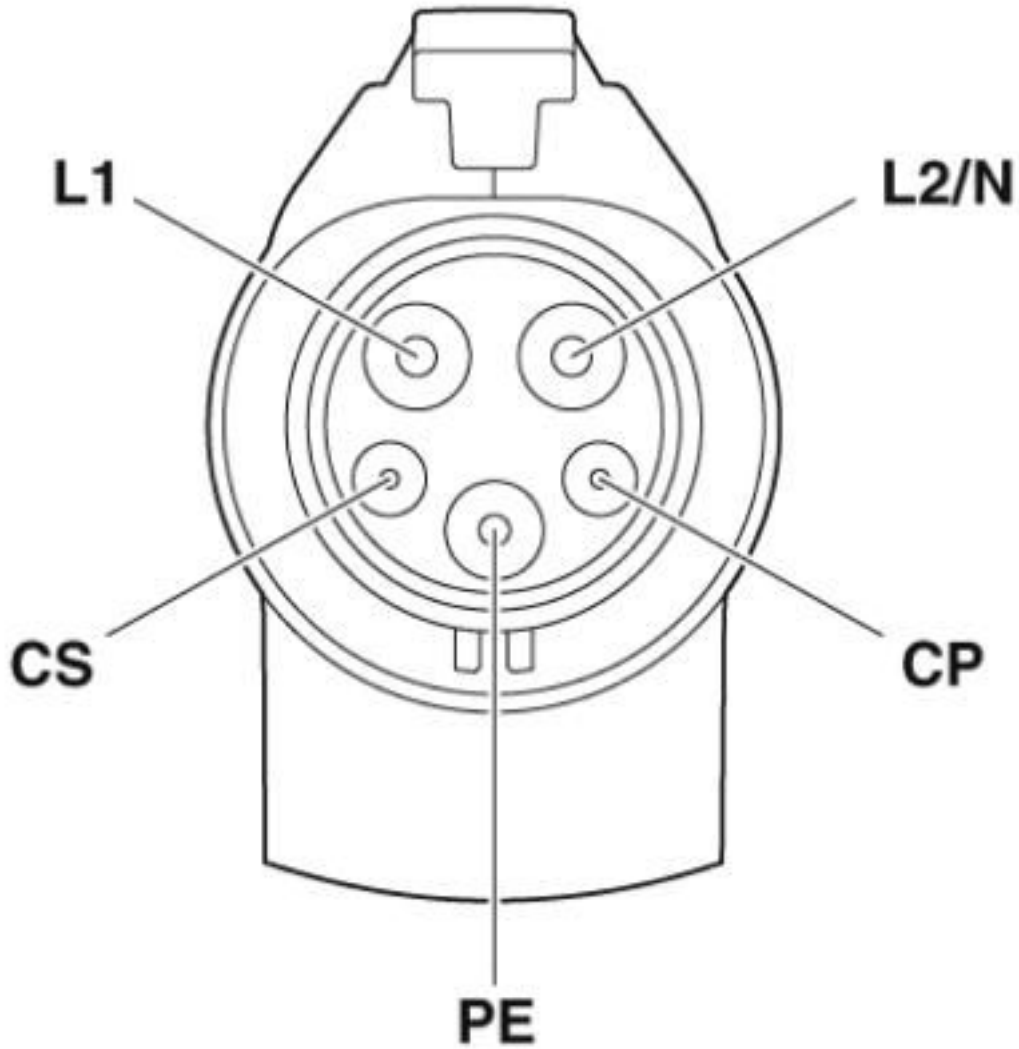

Pin assignment of the Vehicle Connector

AC charging cable - EV-TAG3PC-1AC20A-4,0M2,5EHBK01 - 1628025

Connection diagram

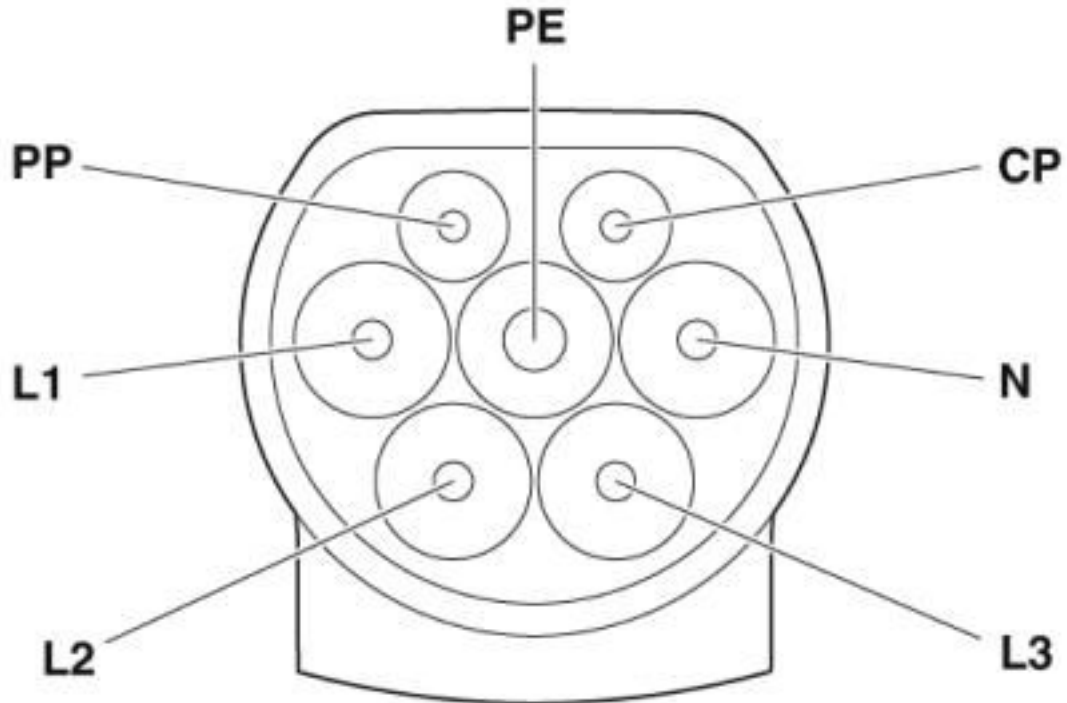

Pin assignment of Infrastructure Plug

Dimensional drawing

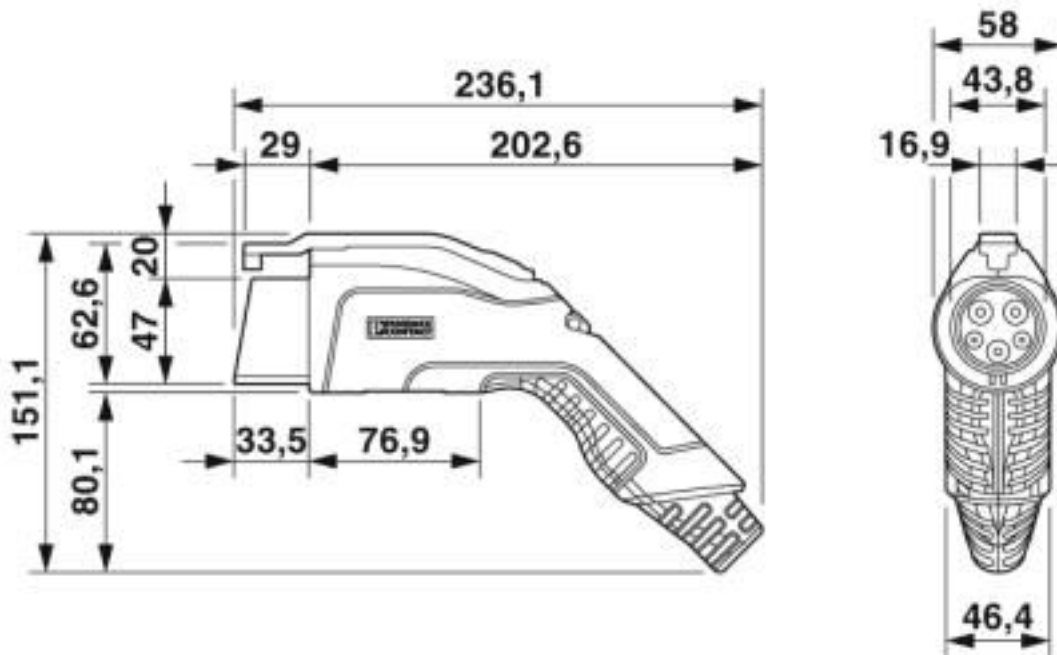

Vehicle connector

AC charging cable - EV-TAG3PC-1AC20A-4,0M2,5EHBK01 - 1628025

Dimensional drawing

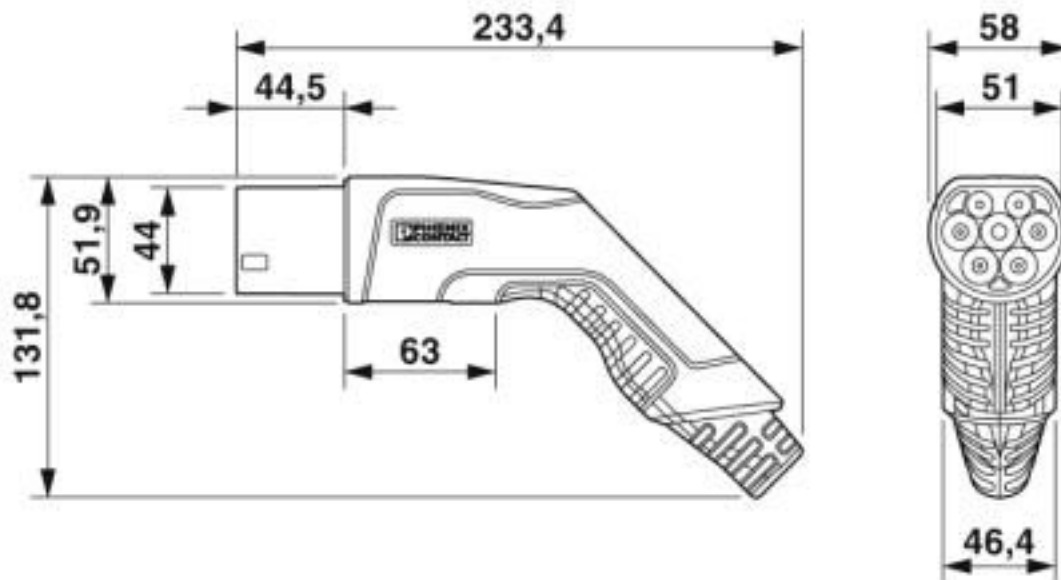

Infrastructure plug

Schematic diagram



Terminology definition

Classifications

eCI@ss

eCI@ss 10.0.1	27144705
eCI@ss 4.0	27140800
eCI@ss 4.1	27140800
eCI@ss 5.0	27143400
eCI@ss 5.1	27143400

AC charging cable - EV-TAG3PC-1AC20A-4,0M2,5EHBK01 - 1628025

Classifications

eCl@ss

eCl@ss 6.0	27143400
eCl@ss 7.0	27449001
eCl@ss 8.0	27449001
eCl@ss 9.0	27144705

ETIM

ETIM 3.0	EC002061
ETIM 4.0	EC002061
ETIM 5.0	EC002839
ETIM 6.0	EC002897
ETIM 7.0	EC002897

UNSPSC

UNSPSC 6.01	30211923
UNSPSC 7.0901	39121522
UNSPSC 11	39121522
UNSPSC 12.01	39121522
UNSPSC 13.2	39121522
UNSPSC 18.0	39121522
UNSPSC 19.0	39121522
UNSPSC 20.0	39121522
UNSPSC 21.0	39121522

Approvals

Approvals

Approvals

IECEE CB Scheme / VDE Zeichengenehmigung

Ex Approvals

Approval details

IECEE CB Scheme		http://www.iecee.org/	DE1-60858
Nominal voltage UN	250 V		
Nominal current IN	20 A		

AC charging cable - EV-TAG3PC-1AC20A-4,0M2,5EHBK01 - 1628025

Approvals

VDE Zeichengenehmigung		http://www2.vde.com/de/Institut/Online-Service/VDE-gepruefteProdukte/Seiten/Online-Suche.aspx	40045426
Nominal voltage UN		250 V	
Nominal current IN		20 A	

Accessories

Accessories

Infrastructure socket outlet

Socket Outlet - EV-T2M3SE12-3AC20A-0,7M2,5E10 - 1405213



Socket Outlet, rear protective cover screw connection, For charging electric vehicles (EV) with alternating current (AC), Compatible with infrastructure charging plugs, Type 2, IEC 62196-2, 20 A / 480 V (AC), Single wires, length: 0.7 m, Locking actuator: 12 V, 4-position, Rear panel mounting, Generation 1, "PHOENIX CONTACT" logo

Socket Outlet - EV-T2M3SE24-3AC20A-0,7M2,5E10 - 1405215



Socket Outlet, rear protective cover screw connection, For charging electric vehicles (EV) with alternating current (AC), Compatible with infrastructure charging plugs, Type 2, IEC 62196-2, 20 A / 480 V (AC), Single wires, length: 0.7 m, Locking actuator: 24 V, 4-position, Rear panel mounting, Generation 1, "PHOENIX CONTACT" logo

Park position

Park position - EV-T1AC-PARK - 1624139



Park position, Retainer for Vehicle Connector as parking position at charging stations (EVSE), Type 1, SAE J1772, Front mounting

Phoenix Contact 2020 © - all rights reserved
<http://www.phoenixcontact.com>

PHOENIX CONTACT GmbH & Co. KG
Flachmarktstr. 8
32825 Blomberg
Germany
Tel. +49 5235 300
Fax +49 5235 3 41200
<http://www.phoenixcontact.com>

Mouser Electronics

Authorized Distributor

Click to View Pricing, Inventory, Delivery & Lifecycle Information:

[Phoenix Contact:](#)

[1628025](#)