

# Contact insert - HC-DD108-I-CT-F - 1584130

Please be informed that the data shown in this PDF Document is generated from our Online Catalog. Please find the complete data in the user's documentation. Our General Terms of Use for Downloads are valid (<http://phoenixcontact.com/download>)



HEAVYCON female insert, DD108 series, 108-pos., crimp connection

## Your advantages

- ✔ Can be used in rail vehicles, satisfy DIN EN 45545-2 with requirement sets R22, R23, and R24 in hazard levels HL1, HL2, and HL3.



## Key Commercial Data

Packing unit	1 pc
GTIN	
GTIN	4046356133449

## Technical data

### General

Note	For housing HC-B24
	Connectors may be operated only when there is no load/voltage.
	It is imperative that guide pins (HC-CST) and sockets (HC-CBU) are used to prevent tip collision due to misalignment.
Connection method	Crimp connection
Torque	0.8 Nm ... 1.2 Nm (PE connection)
	0.5 Nm ... 0.8 Nm (Mounting screws for mounting in the HEAVYCON housing)
Number of connections per position	1
Degree of pollution	3
Overvoltage category	III
Number of positions	108+PE
Insertion/withdrawal cycles	≥ 500
Size	B24
	B48
Contact numbering	1 - 108

# Contact insert - HC-DD108-I-CT-F - 1584130

## Technical data

### General

Conductor cross section	0.14 mm <sup>2</sup> ... 2.5 mm <sup>2</sup>
Connection cross section AWG	26 ... 14
Stripping length of the individual wire	8 mm (0.14 ... 1.5 mm <sup>2</sup> )
	6 mm (2.5 mm <sup>2</sup> )
Minimum housing height	72 mm
Assembly instructions	To ensure correct use, installation in housing with IP54 protection or better is required

### Ambient conditions

Ambient temperature (operation)	-40 °C ... 125 °C (including heating up of contacts)
---------------------------------	--

### Material data

Contact material	Copper alloy
Contact surface material	Ag (alternatively Au)
Contact carrier material	PC
Standards/regulations	PC: Fire protection in rail vehicles - requirement sets R22, R23, and R24 acc. to DIN EN 45545-2 (Risk level HL1 - HL3)

### Electrical characteristics

Rated voltage (III/3)	250 V
Rated surge voltage	4 kV
Rated current	10 A

### Standards and Regulations

Connection in acc. with standard	CSA
Constructional and testing regulations	DIN VDE 0627/86
	DIN VDE 0110/02.79
	DIN VDE 0110-1/04.97
	IEC 60664-1, DIN IEC 60512
	IEC 60352
Flammability rating according to UL 94	V0
Standards/regulations	acc. to DIN EN 45545-2

### Environmental Product Compliance

China RoHS	Environmentally friendly use period: unlimited = EFUP-e
	No hazardous substances above threshold values

## Drawings

# Contact insert - HC-DD108-I-CT-F - 1584130

Schematic diagram

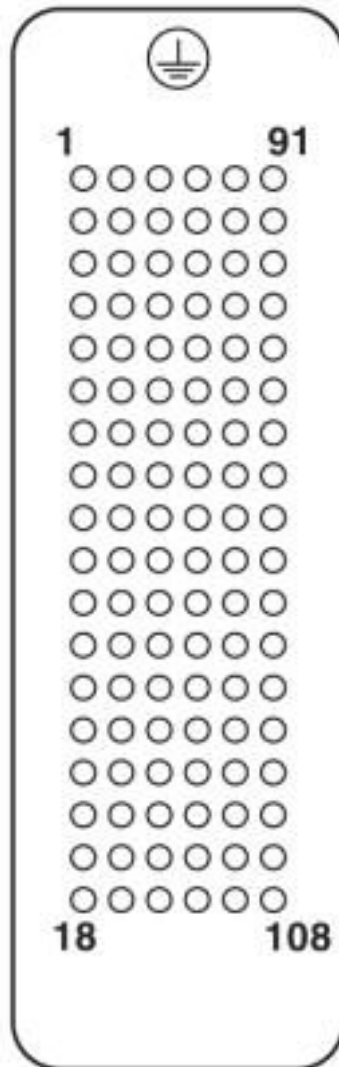

Connector pin assignment, connection side

# Contact insert - HC-DD108-I-CT-F - 1584130

Diagram

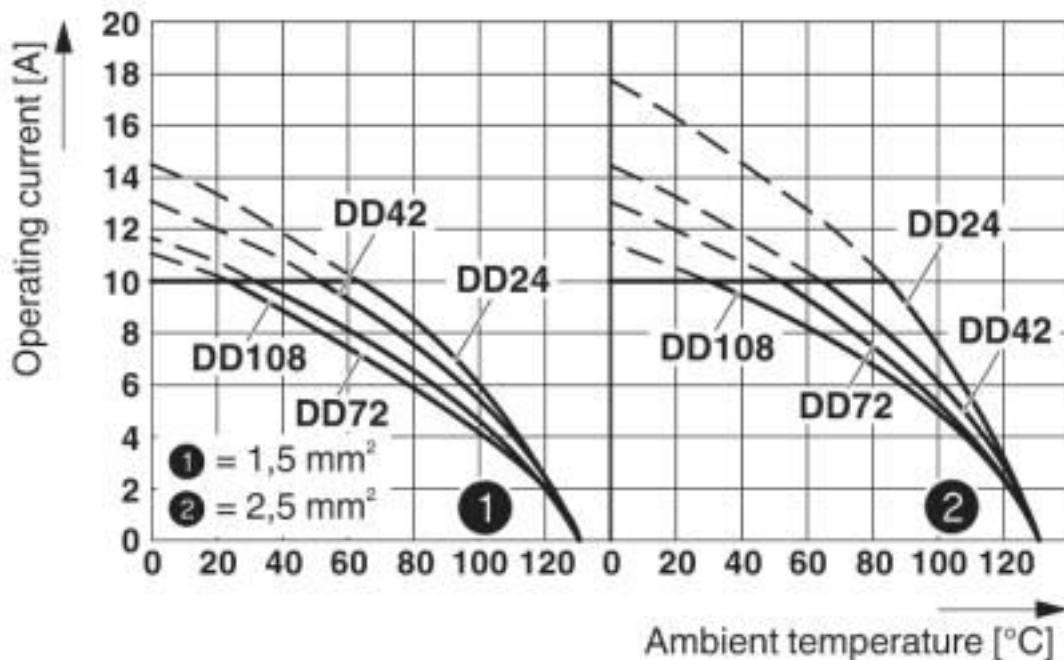

Derating diagram

Dimensional drawing

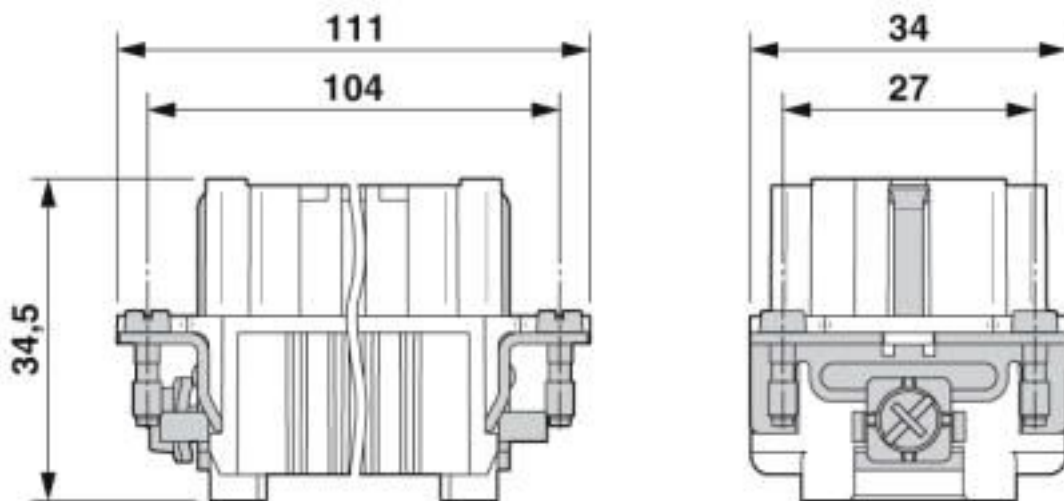

Female insert

# Contact insert - HC-DD108-I-CT-F - 1584130

Dimensional drawing

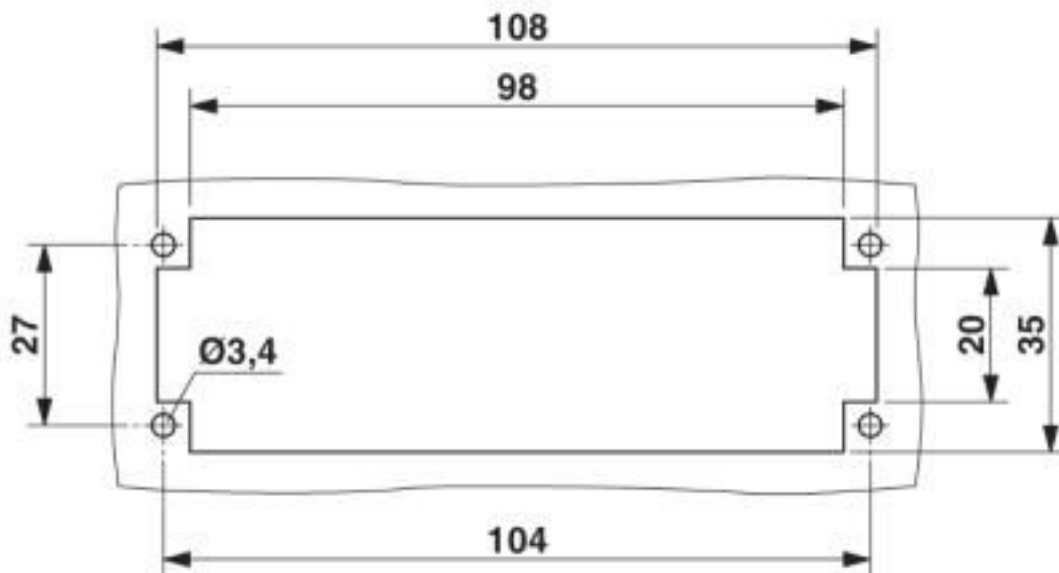

Mounting cutout when used without housing

## Classifications

eCl@ss

eCl@ss 10.0.1	27440205
eCl@ss 4.0	27140800
eCl@ss 4.1	27140800
eCl@ss 5.0	27143400
eCl@ss 5.1	27261200
eCl@ss 6.0	27261200
eCl@ss 7.0	27440205
eCl@ss 8.0	27440205
eCl@ss 9.0	27440205

ETIM

ETIM 3.0	EC000438
ETIM 4.0	EC000437
ETIM 5.0	EC000438
ETIM 6.0	EC000438
ETIM 7.0	EC000438

UNSPSC

UNSPSC 6.01	30211923
UNSPSC 7.0901	39121522
UNSPSC 11	39121522
UNSPSC 12.01	39121522

# Contact insert - HC-DD108-I-CT-F - 1584130

## Classifications

### UNSPSC

UNSPSC 13.2	39121522
UNSPSC 18.0	39121522
UNSPSC 19.0	39121522
UNSPSC 20.0	39121522
UNSPSC 21.0	39121522

## Approvals

### Approvals

#### Approvals

CSA / UL Recognized / cUL Recognized / EAC / DNV GL / EAC / cULus Recognized

#### Ex Approvals

### Approval details

CSA		<a href="http://www.csagroup.org/services-industries/product-listing/">http://www.csagroup.org/services-industries/product-listing/</a>	013631_6233_01
Nominal voltage UN		250 V	
Nominal current IN		7 A	
mm <sup>2</sup> /AWG/kcmil		26-14	

UL Recognized		<a href="http://database.ul.com/cgi-bin/XYV/template/LISEXT/1FRAME/index.htm">http://database.ul.com/cgi-bin/XYV/template/LISEXT/1FRAME/index.htm</a>	FILE E 118976
Nominal voltage UN		250 V	
Nominal current IN		10 A	
mm <sup>2</sup> /AWG/kcmil		14	

cUL Recognized		<a href="http://database.ul.com/cgi-bin/XYV/template/LISEXT/1FRAME/index.htm">http://database.ul.com/cgi-bin/XYV/template/LISEXT/1FRAME/index.htm</a>	FILE E 118976
Nominal voltage UN		250 V	
Nominal current IN		7 A	
mm <sup>2</sup> /AWG/kcmil		14	

## Contact insert - HC-DD108-I-CT-F - 1584130

### Approvals

EAC		RU C- DE.AI30.B.01102
-----	--	--------------------------

DNV GL		<a href="https://approvalfinder.dnvgl.com/">https://approvalfinder.dnvgl.com/</a>	TAE000037S
--------	--	---	------------

EAC		RU C- DE.BL08.B.00511
-----	--	--------------------------

cULus Recognized		
------------------	--	--

### Accessories

#### Accessories

#### Assembly tool

Assembly tool - UNIFOX MT-CK 1.6/2.5 - 1089092



Assembly tool, for CK 1.6... crimp contacts for small conductor cross sections

---

#### Coding element

Coding element - HC-CBU - 1676860



Coding socket for coding up to 16 connectors

---

Coding element - HC-CST - 1676857



Coding peg for coding up to 16 connectors

## Contact insert - HC-DD108-I-CT-F - 1584130

### Accessories

---

Coding bolt - HC-CB - 1772722



Coding pin, prevents mismatching of up to six connectors with an identical number of positions

---

### Crimp contact

Crimp contact - CK1,6-ED-0,37BU AG - 1663394



Turned 1.6 crimp contact, individual female contact, core diameter 0.14 to 0.37 mm<sup>2</sup>, silver-plated

---

Crimp contact - CK1,6-ED-0,50BU AG - 1663404



Turned 1.6 crimp contact, individual female contact, core diameter 0.5 mm<sup>2</sup>, silver-plated

---

Crimp contact - CK1,6-ED-0,75BU AG - 1663417



Turned 1.6 crimp contact, individual female contact, core diameter 0.75 mm<sup>2</sup>, silver-plated

---

Crimp contact - CK1,6-ED-1,00BU AG - 1663420



Turned 1.6 crimp contact, individual female contact, core diameter 0.75 to 1.00 mm<sup>2</sup>, silver-plated

---



## Contact insert - HC-DD108-I-CT-F - 1584130

### Accessories

Crimp contact - CK1,6-ED-1,50BU AG - 1663433



Turned 1.6 crimp contact, individual female contact, core diameter 1.5 mm<sup>2</sup>, silver-plated

---

Crimp contact - CK1,6-ED-2,50BU AG - 1663446



Turned 1.6 crimp contact, individual female contact, core diameter 2.5 mm<sup>2</sup>, silver-plated

---

Crimp contact - CK1,6-ED-0,37BU AU - 1674969



Turned 1.6 crimp contact, individual female contact, core diameter 0.14 to 0.37 mm<sup>2</sup>, gold-plated

---

Crimp contact - CK1,6-ED-0,50BU AU - 1674480



Turned 1.6 crimp contact, individual female contact, core diameter 0.5 mm<sup>2</sup>, gold-plated

---

Crimp contact - CK1,6-ED-0,75BU AU - 1672440



Turned 1.6 crimp contact, individual female contact, core diameter 0.75 mm<sup>2</sup>, gold-plated

---

## Contact insert - HC-DD108-I-CT-F - 1584130

### Accessories

Crimp contact - CK1,6-ED-1,00BU AU - 1674943



Turned 1.6 crimp contact, individual female contact, core diameter 0.75 to 1.00 mm<sup>2</sup>, gold-plated

---

Crimp contact - CK1,6-ED-1,50BU AU - 1674930



Turned 1.6 crimp contact, individual female contact, core diameter 1.5 mm<sup>2</sup>, gold-plated

---

Crimp contact - CK1,6-ED-2,50BU AU - 1674985



Turned 1.6 crimp contact, individual female contact, core diameter 2.5 mm<sup>2</sup>, gold-plated

---

Crimp contact - CK1,6-ER-1,00BU OIC AG - 1004362



Crimp contact, contact diameter: 1.6 mm, rolled, Socket, contact material: Cu alloy, nickel-plated, contact surface: silver-plated, connection cross section: 0.34 mm<sup>2</sup> ... 1 mm<sup>2</sup> AWG 22 ... 17

---

Crimp contact - CK1,6-ER-2,50BU OIC AG - 1004366



Crimp contact, contact diameter: 1.6 mm, rolled, Socket, contact material: Cu alloy, nickel-plated, contact surface: silver-plated, connection cross section: 1.5 mm<sup>2</sup> ... 2.5 mm<sup>2</sup> AWG 16 ... 14

---

## Contact insert - HC-DD108-I-CT-F - 1584130

### Accessories

Crimp contact - CK1,6-BR-1,00BU OIC AG - 1004381



Crimp contact, contact diameter: 1.6 mm, rolled, Socket, contact material: Cu alloy, nickel-plated, contact surface: silver-plated, connection cross section: 0.34 mm<sup>2</sup> ... 1 mm<sup>2</sup> AWG 22 ... 17

Crimp contact - CK1,6-BR-2,50BU OIC AG - 1004383



Crimp contact, contact diameter: 1.6 mm, rolled, Socket, contact material: Cu alloy, nickel-plated, contact surface: silver-plated, connection cross section: 1.5 mm<sup>2</sup> ... 2.5 mm<sup>2</sup> AWG 16 ... 14

### Crimping tool

Crimping pliers - CRIMPFOX-TC 4 - 1212113



Crimping pliers, for CK 1,6-ED..., CK 2,5-ED..., CK 4,0-ED... turned contacts, 4 marked die stations, unlockable pressure lock, lateral entry, incl. positioning tool

### Docking frame

Docking frames - HC-B 24-ANDOCK - 1586141



Docking frame for racks, for contact inserts of B24 type, with four M5 flat headed screws, rack balance x/y axis +/- 1.5 mm

### Fiber optics contact

Female contact - CK1,6-ED-BU-POF - 1885004



POF fiber optic socket contact, turned, for contact carriers (HC-DD...I-CT.../ HC-M-12-CT-F.../ HC-M-17-CT-F...) of CK1,6-ED... contacts

### Mounting material

## Contact insert - HC-DD108-I-CT-F - 1584130

### Accessories

Screw - HC-B-PES - 1604997



PE screw, for contact inserts HC-B / HC-BB / HC-DD / HC-D40 / HC-D64

---

PE multiplier - HC-B-3PE - 1644326



PE multiplier, for three PE connections, for HC-B (besides HC-B..E..ZZ) / HC-BB / HC-DD / HC-D40 / HC-D64 contact inserts

---

Strain relief clamp - HC-B-ZG - 1685327



Strain relief clamps contact inserts of series: B-, BB-, D 40, D 64, DD and HV, straight cable exit

---

Strain relief clamp - HC-B-ZS - 1685330



Strain relief clamps contact inserts of series: B-, BB-, D 40, D 64, DD and HV, lateral cable exit

---

### Universal tools

Contact removal tool - UNIFOX RT-CK 1.6 - 1072069



Contact removal tool, for turned and rolled CK- 1.6-... contacts

---

### Additional products

## Contact insert - HC-DD108-I-CT-F - 1584130

### Accessories

Contact insert - HC-DD108-I-CT-M - 1584114



HEAVYCON male insert, DD108 series, 108-pos., crimp connection

---

Phoenix Contact 2020 © - all rights reserved  
<http://www.phoenixcontact.com>

PHOENIX CONTACT GmbH & Co. KG  
Flachsmarktstr. 8  
32825 Blomberg  
Germany  
Tel. +49 5235 300  
Fax +49 5235 3 41200  
<http://www.phoenixcontact.com>

# Mouser Electronics

Authorized Distributor

Click to View Pricing, Inventory, Delivery & Lifecycle Information:

[Phoenix Contact:](#)

[1584130](#)