

# Sensor/actuator cable - SAC-8P-M 8MR/ 0,15-PUR/M 8FR - 1424272

Please be informed that the data shown in this PDF Document is generated from our Online Catalog. Please find the complete data in the user's documentation. Our General Terms of Use for Downloads are valid (<http://phoenixcontact.com/download>)

Sensor/actuator cable, 8-position, PUR halogen-free, black-gray RAL 7021, Plug angled M8, on Socket angled M8

## Your advantages

- ✓ Easy and safe: 100% electrically tested plug-in components



## Key Commercial Data

Packing unit	1 pc
Minimum order quantity	50 pc
GTIN	 4 055626 370187
GTIN	4055626370187

## Technical data

### General

Rated current at 40°C	1.5 A
Rated voltage	30 V AC
	30 V DC
Number of positions	8
Coding	A - standard
Standards/regulations	M8 connector IEC 61076-2-104
Status display	No
Protective circuit/component	unwired
Degree of pollution	3
Insertion/withdrawal cycles	≥ 100
Torque	0.2 Nm (M8 connectors)

### Material

Flammability rating according to UL 94	HB
--	----

### Standards and Regulations

Standards/specifications	M8 connector IEC 61076-2-104
Flammability rating according to UL 94	HB

### Cable

Cable abbreviation	Li9Y11Y
--------------------	---------

# Sensor/actuator cable - SAC-8P-M 8MR/ 0,15-PUR/M 8FR - 1424272

## Technical data

### Cable

UL AWM style	20549
Conductor cross section	8x 0.14 mm <sup>2</sup> (Signal line)
AWG signal line	26
Conductor structure signal line	18x 0.10 mm
Core diameter including insulation	1 mm ±0.02 mm (Signal line)
Thickness, insulation	≥ 0.21 mm (Signal line)
	≥ 0.38 mm (Outer cable sheath)
Wire colors	white, brown, green, yellow, gray, pink, blue, red
Overall twist	8 wires around filler to the core
Length of twist, overall twist	58 mm
External sheath, color	black-gray RAL 7021
External cable diameter D	5.1 mm ±0.15 mm
Smallest bending radius, fixed installation	25.5 mm
Smallest bending radius, movable installation	51 mm
Number of bending cycles	4000000
Bending radius	51 mm
Traversing path	10 m
Traversing rate	3 m/s
Acceleration	10 m/s <sup>2</sup>
Outer sheath, material	PUR
Material, filler	PE
Material conductor insulation	PP
Conductor material	Bare Cu litz wires
Insulation resistance	1 GΩ*km (at 20 °C)
Conductor resistance	139 Ω/km (at 20 °C)
Nominal voltage, cable	≤ 300 V AC
Test voltage, cable	≥ 3000 V AC (Spark test)
Flame resistance	according to UL 758/1581 (horizontal)
	in accordance with UL 758/1581 FT2
Halogen-free	in accordance with DIN VDE 0472 part 815
	in accordance with DIN EN 50267-2-1
Resistance to oil	According to DIN EN 60811-2-1, 168 h at 100°C
Other resistance	hydrolysis and microbe resistant
	Resistant to salt water
	Low adhesion
	abrasion-resistant
	partly UV-resistant in accordance with DIN EN ISO 4892-2-A
Ambient temperature (operation)	-40 °C ... 80 °C (cable, fixed installation)
	-25 °C ... 80 °C (cable, flexible installation)

### Environmental Product Compliance

# Sensor/actuator cable - SAC-8P-M 8MR/ 0,15-PUR/M 8FR - 1424272

## Technical data

### Environmental Product Compliance

REACH SVHC	Lead 7439-92-1
China RoHS	Environmentally Friendly Use Period = 50 years
	For details about hazardous substances go to tab "Downloads", Category "Manufacturer's declaration"

## Drawings

Schematic diagram

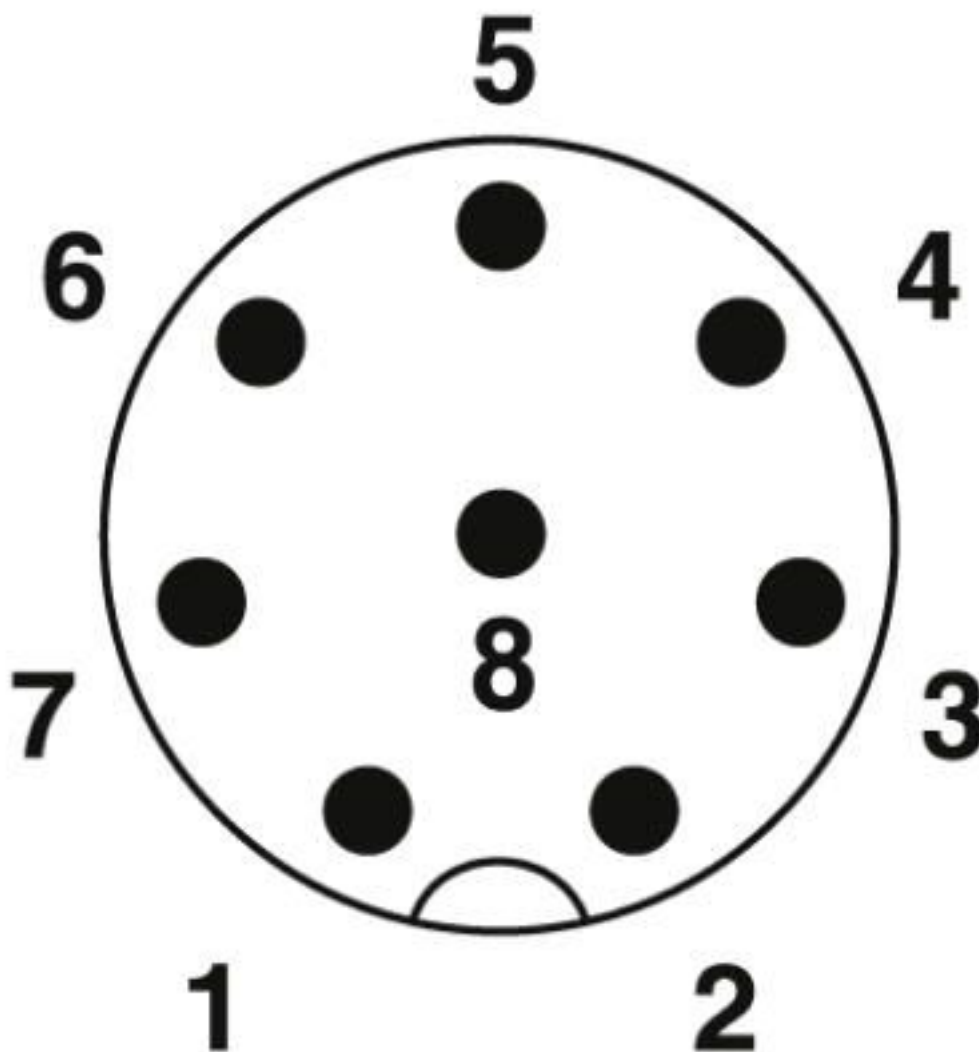

M8 plug pin assignment, 8-pos., view of pin side

# Sensor/actuator cable - SAC-8P-M 8MR/ 0,15-PUR/M 8FR - 1424272

Schematic diagram



Connector pin assignment of M8 socket, 8-pos., view of socket side

# Sensor/actuator cable - SAC-8P-M 8MR/ 0,15-PUR/M 8FR - 1424272

Dimensional drawing

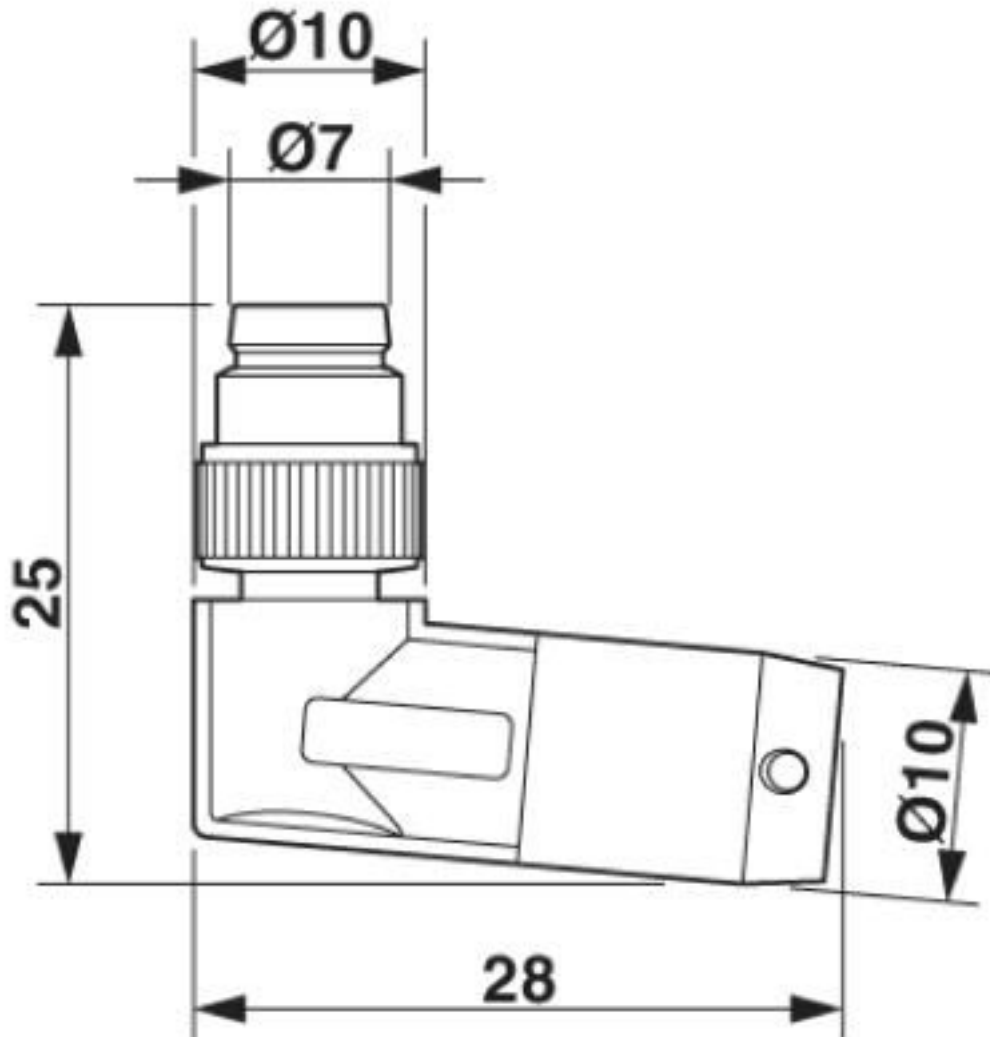

M8 x 1 male plug, angled version

# Sensor/actuator cable - SAC-8P-M 8MR/ 0,15-PUR/M 8FR - 1424272

Dimensional drawing

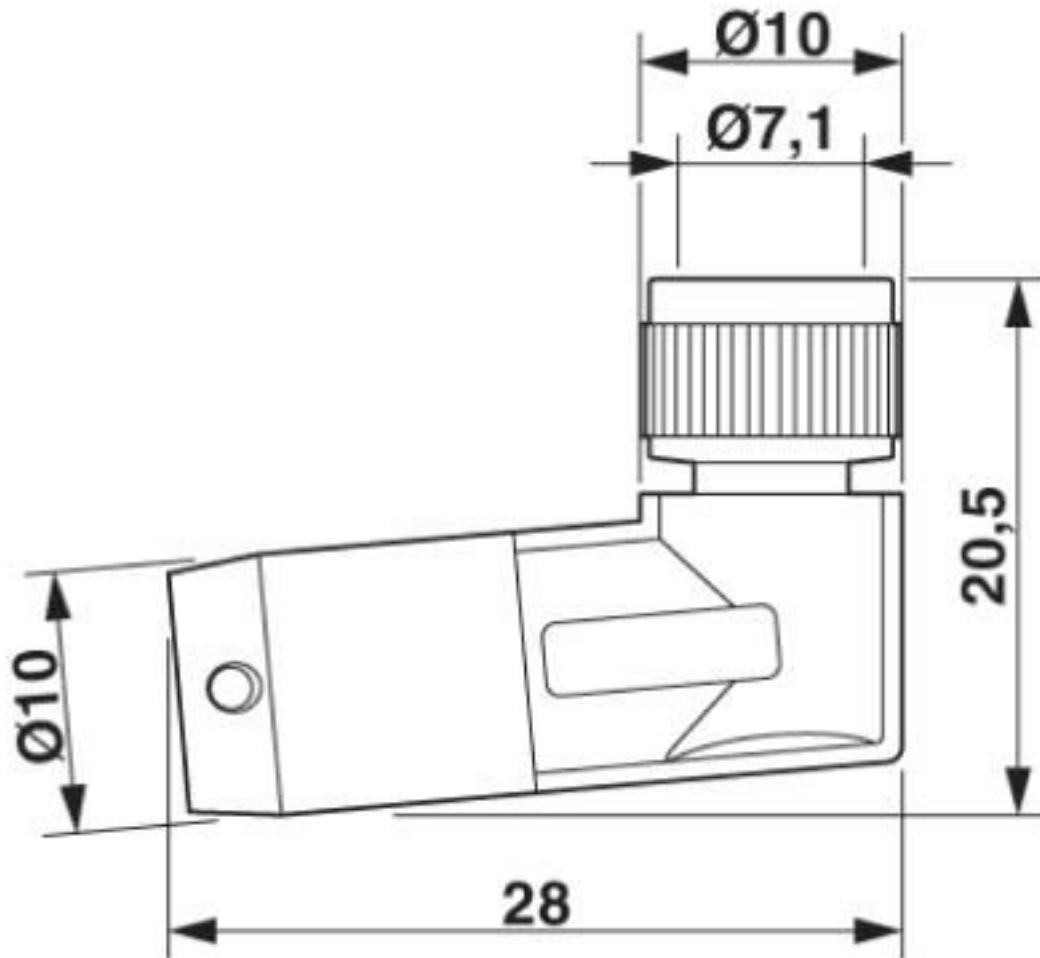

Socket M8 x 1, angled

## Sensor/actuator cable - SAC-8P-M 8MR/ 0,15-PUR/M 8FR - 1424272

Circuit diagram

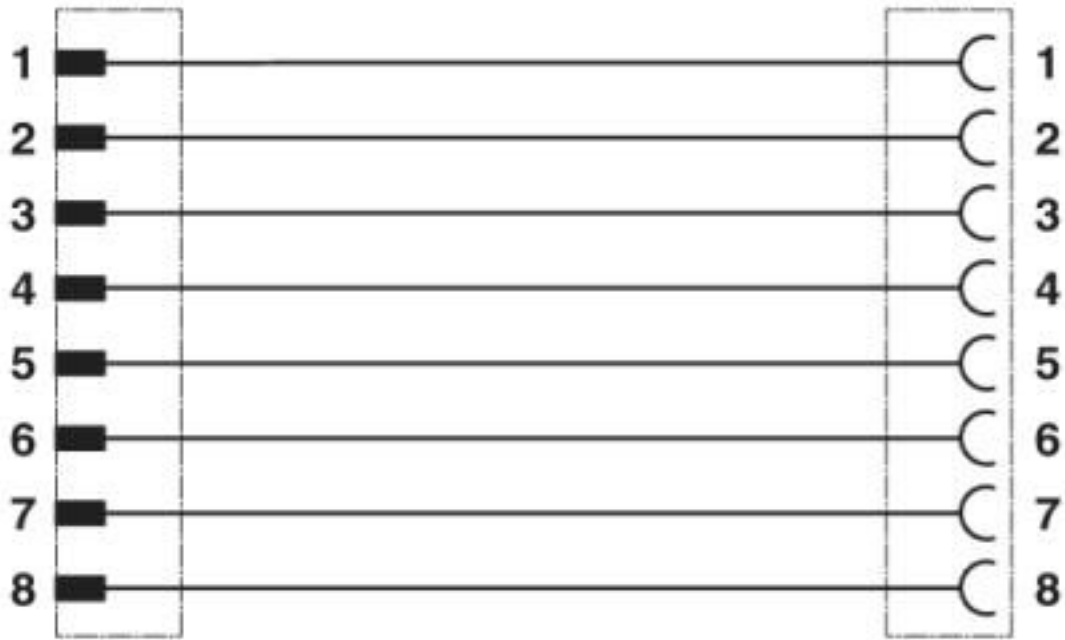

Contact assignment of M8 plugs/sockets

# Sensor/actuator cable - SAC-8P-M 8MR/ 0,15-PUR/M 8FR - 1424272

Cable cross section



PUR halogen-free black [PUR]

## Classifications

eCl@ss

eCl@ss 10.0.1	27060311
eCl@ss 6.0	27279200
eCl@ss 7.0	27279218
eCl@ss 9.0	27060311

ETIM

ETIM 5.0	EC001855
ETIM 6.0	EC001855
ETIM 7.0	EC001855



# Sensor/actuator cable - SAC-8P-M 8MR/ 0,15-PUR/M 8FR - 1424272

## Approvals

### Approvals

---

#### Approvals

UL Listed / cUL Listed / cULus Listed

---

#### Ex Approvals

---

### Approval details

UL Listed		<a href="http://database.ul.com/cgi-bin/XYV/template/LISEXT/1FRAME/index.htm">http://database.ul.com/cgi-bin/XYV/template/LISEXT/1FRAME/index.htm</a>	FILE E 221474
Nominal voltage UN		30 V	
Nominal current IN		1.5 A	

cUL Listed		<a href="http://database.ul.com/cgi-bin/XYV/template/LISEXT/1FRAME/index.htm">http://database.ul.com/cgi-bin/XYV/template/LISEXT/1FRAME/index.htm</a>	FILE E 221474
Nominal voltage UN		30 V	
Nominal current IN		1.5 A	

cULus Listed			
--------------	---	--	--

---

Phoenix Contact 2020 © - all rights reserved  
<http://www.phoenixcontact.com>

PHOENIX CONTACT GmbH & Co. KG  
Flachsmarktstr. 8  
32825 Blomberg  
Germany  
Tel. +49 5235 300  
Fax +49 5235 3 41200  
<http://www.phoenixcontact.com>

# Mouser Electronics

Authorized Distributor

Click to View Pricing, Inventory, Delivery & Lifecycle Information:

[Phoenix Contact:](#)

[1424272](#)