

Power cable - SAC-6P-M12MRM/10,0-PUR PE SH - 1414946

Please be informed that the data shown in this PDF Document is generated from our Online Catalog. Please find the complete data in the user's documentation. Our General Terms of Use for Downloads are valid (<http://phoenixcontact.com/download>)



Power cable, 6-position, PUR halogen-free, orange RAL 2003, shielded (Advanced Shielding Technology), Plug angled M12, coding: M, on free cable end, cable length: 10 m, For AC current up to 8 A/690 V

Your advantages

- ✓ Easy and safe: 100% electrically tested plug-in components
- ✓ High-performance: AC connectors for up to 8 A and 630 V AC
- ✓ Protection against mismatching, thanks to special M-coding
- ✓ Shield power reliably – 360° shielding to reduce electromagnetic loads
- ✓ Our standard: robust halogen-free PUR cable

Key Commercial Data

Packing unit	1 pc
GTIN	 4 055626 035734
GTIN	4055626035734

Technical data

Dimensions

Length of cable	10 m
-----------------	------

Ambient conditions

Ambient temperature (operation)	-25 °C ... 85 °C (Plug / socket)
Degree of protection	IP65
	IP67 (without preloading, as additional test in accordance with IEC 60529)

General

Rated current at 40°C	8 A
Rated voltage	690 V AC
Number of positions	6
Insulation resistance	≥ 100 MΩ

Power cable - SAC-6P-M12MRM/10,0-PUR PE SH - 1414946

Technical data

General

Coding	M - Power
Standards/regulations	M12 connector IEC 61076-2-111
Status display	No
Protective circuit/component	unwired
Overvoltage category	III
Degree of pollution	3
Torque	0.4 Nm (M12 connector)

Material

Flammability rating according to UL 94	V0
Contact material	CuZn
Contact surface material	Ni/Au
Contact carrier material	PA
Material of grip body	PP
Material, knurls	Zinc die-cast, nickel-plated

Standards and Regulations

Standards/specifications	M12 connector IEC 61076-2-111
Flammability rating according to UL 94	V0

Cable

Cable type	PUR halogen-free black
Cable type (abbreviation)	PUR
UL AWM style	20234 / 10492 (80°C/1000 V)
Conductor cross section	6x 1.5 mm ²
AWG power supply	16
Conductor structure, voltage supply	78x 0.15 mm
Core diameter including insulation	2.35 mm ±0.05 mm
Thickness, insulation	≥ 0.36 mm
Wire colors	black 1, black 2, black 3, black 4, black 5, green/yellow
External sheath, color	orange RAL 2003
Outer sheath thickness	approx. 1.15 mm
External cable diameter D	10.4 mm ±0.3 mm
Minimum bending radius, fixed installation	5 x D
Minimum bending radius, flexible installation	10 x D
Number of bending cycles	2000000
Minimum bending radius, drag chain applications	10 x D
Traversing path	10 m
Traversing rate	3 m/s
Acceleration	10 m/s ²
Cable weight	144 kg/km
Outer sheath, material	PUR

Power cable - SAC-6P-M12MRM/10,0-PUR PE SH - 1414946

Technical data

Cable

Material conductor insulation	PP
Conductor material	Bare Cu litz wires
Insulation resistance	$\geq 1 \text{ G}\Omega \cdot \text{km}$ (at 20 °C)
Conductor resistance	$\leq 15 \text{ }\Omega/\text{m}$ (at 20 °C)
Nominal voltage, cable	$\leq 1000 \text{ V AC}$
Test voltage, cable	$\geq 10000 \text{ V AC}$ (Spark test)
Flame resistance	According to UL 758/1581 (Cable Flame)
	according to UL 758/1581 FT1
	According to DIN EN 60332-1-2
Halogen-free	in accordance with DIN VDE 0472 part 815
	in accordance with DIN EN 50267-2-1
Resistance to oil	according to DIN EN 60811-404, 168 h at 100 °C
Other resistance	Hydrolysis and microbe resistant as per VDE 0282 section 10
	Low adhesion
	abrasion-resistant
	Resistant to salt water
Ambient temperature (operation)	-30 °C ... 80 °C (cable, flexible installation)

Environmental Product Compliance

REACH SVHC	Lead 7439-92-1
China RoHS	Environmentally Friendly Use Period = 50 years
	For details about hazardous substances go to tab "Downloads", Category "Manufacturer's declaration"

Drawings

Power cable - SAC-6P-M12MRM/10,0-PUR PE SH - 1414946

Dimensional drawing

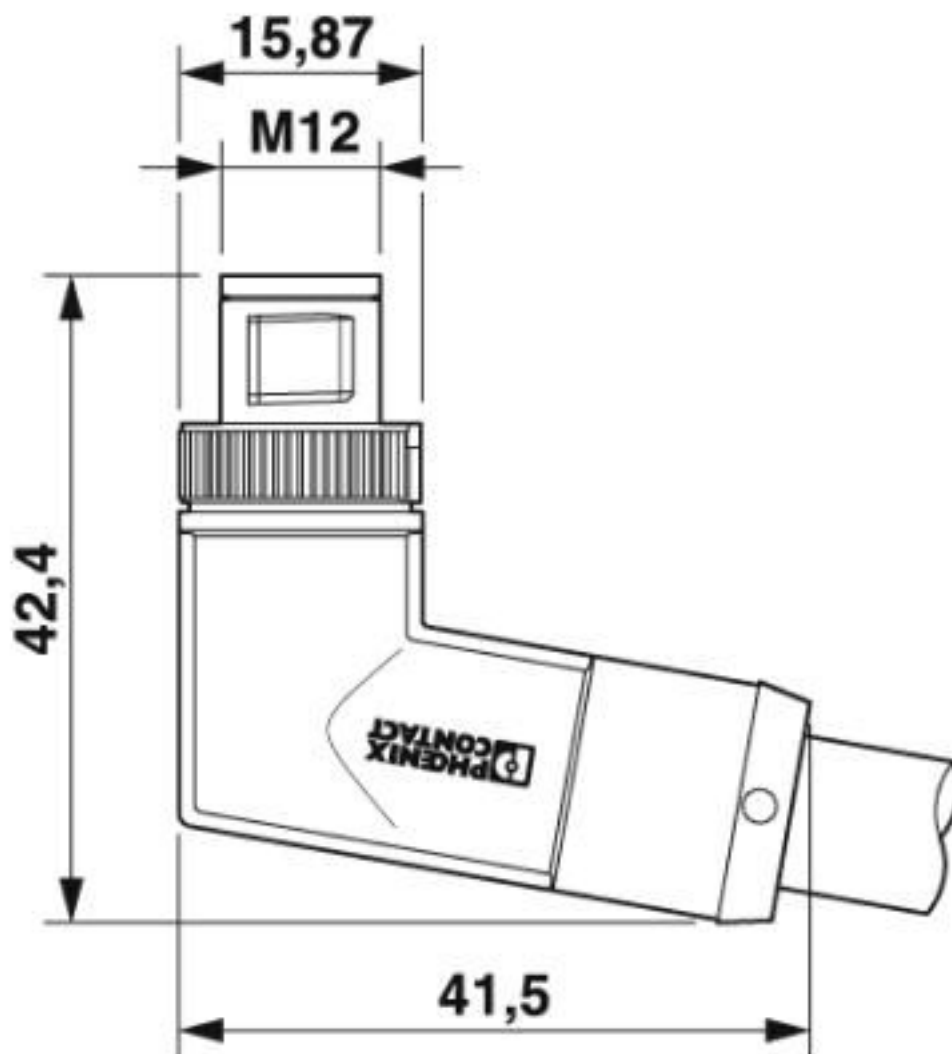

M12 x 1 male plug, angled

Power cable - SAC-6P-M12MRM/10,0-PUR PE SH - 1414946

Schematic diagram

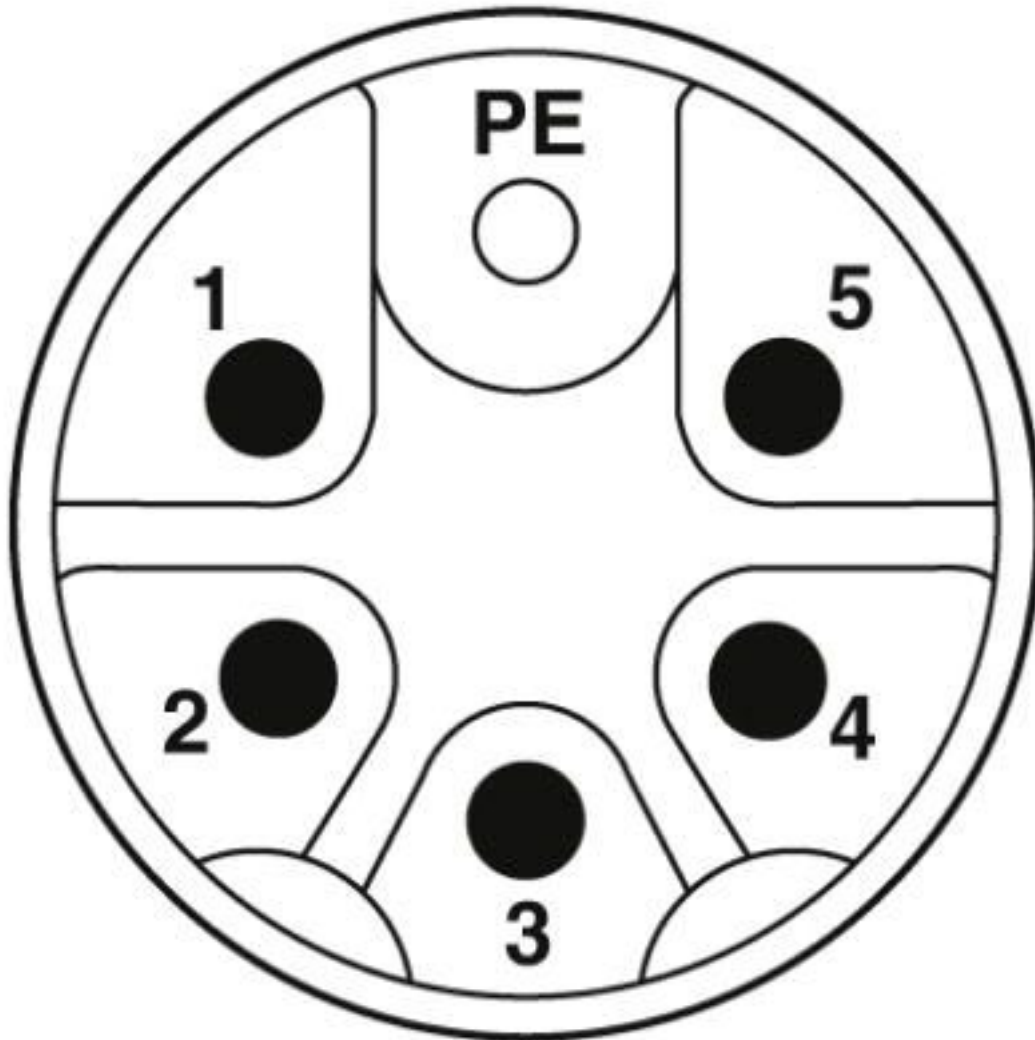

Pin assignment of M12 connector, 6-pos., M-coded, pin side view

Power cable - SAC-6P-M12MRM/10,0-PUR PE SH - 1414946

Diagram

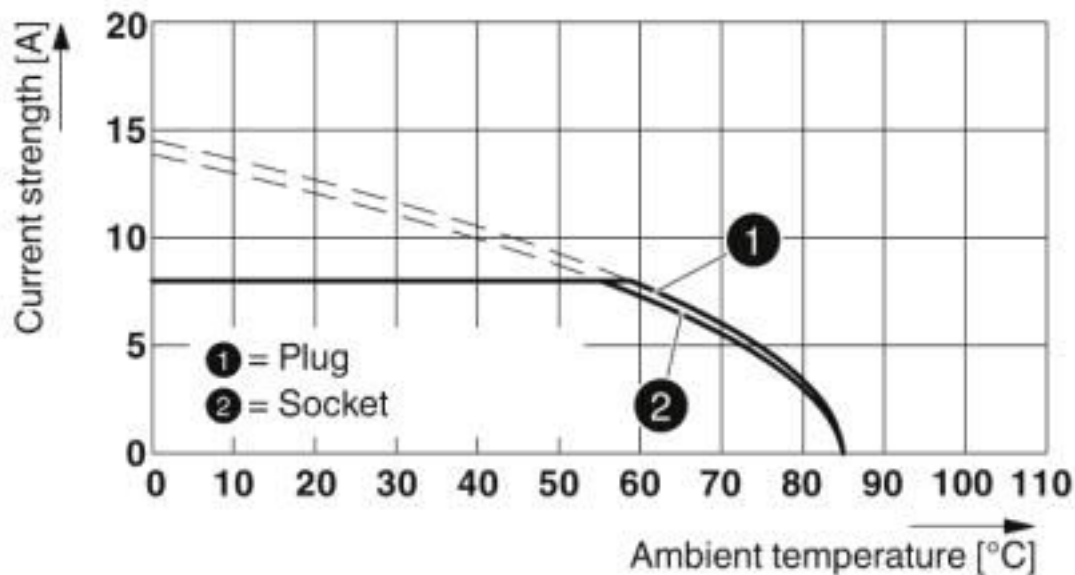

Current carrying capacity

Circuit diagram

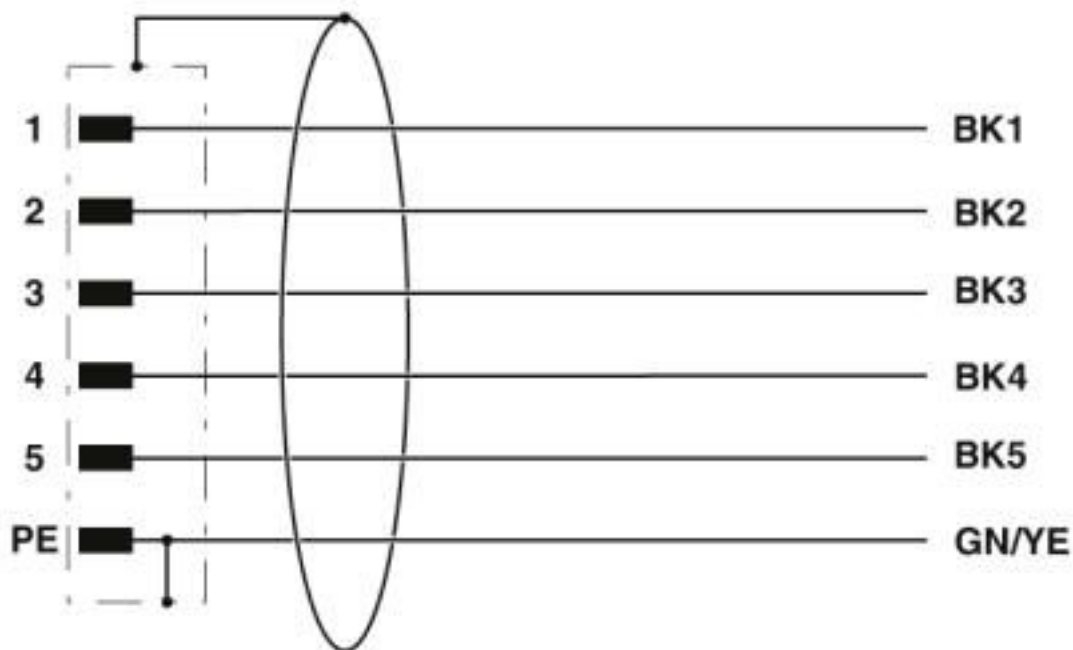

Contact assignment of the M12 plug

Power cable - SAC-6P-M12MRM/10,0-PUR PE SH - 1414946

Cable cross section

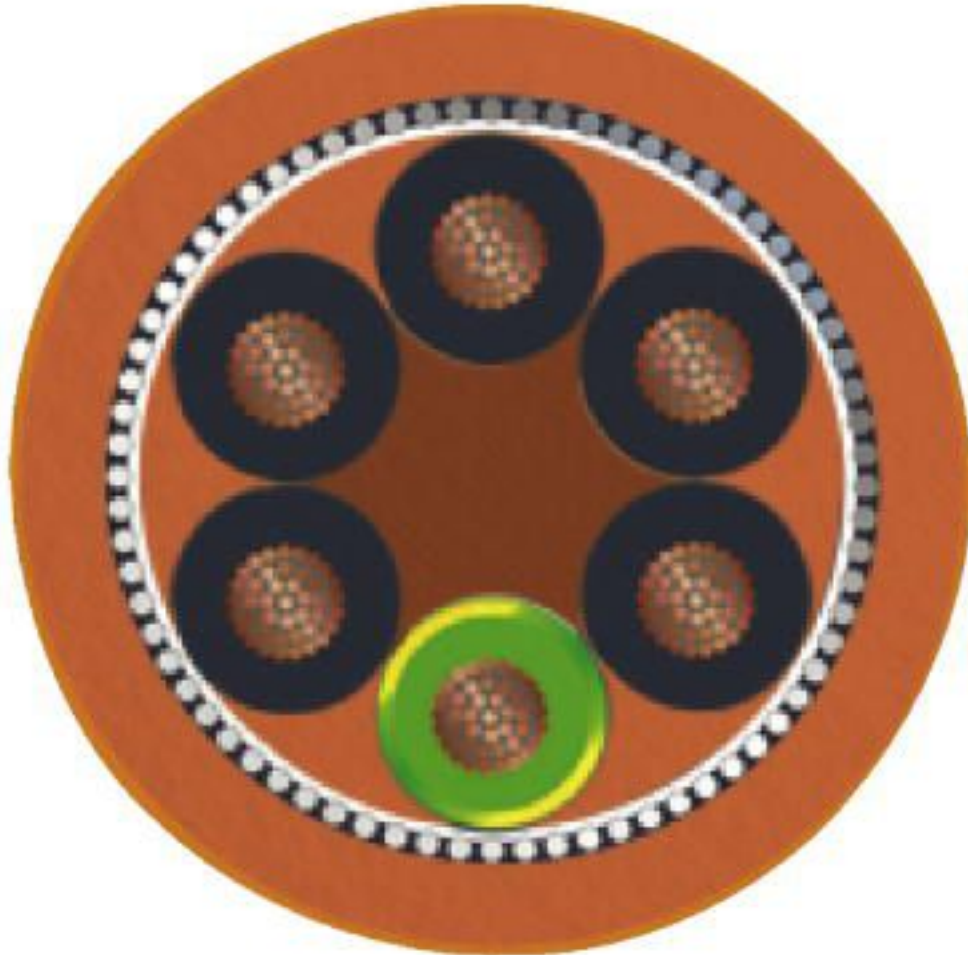

PUR halogen-free black [PUR]

Classifications

eCl@ss

eCl@ss 10.0.1	27440203
eCl@ss 5.1	27061801
eCl@ss 6.0	27279200
eCl@ss 7.0	27279218
eCl@ss 8.0	27440203
eCl@ss 9.0	27440203

ETIM

ETIM 5.0	EC002311
ETIM 6.0	EC002311

Power cable - SAC-6P-M12MRM/10,0-PUR PE SH - 1414946

Classifications

ETIM

ETIM 7.0	EC002311
----------	----------

Approvals

Approvals

Approvals

UL Listed / cUL Listed / EAC-RoHS / cULus Listed

Ex Approvals

Approval details

UL Listed		http://database.ul.com/cgi-bin/XYV/template/LISEXT/1FRAME/index.htm	E468743
Nominal voltage UN		600 V	
Nominal current IN		10 A	
mm ² /AWG/kcmil		16	

cUL Listed		http://database.ul.com/cgi-bin/XYV/template/LISEXT/1FRAME/index.htm	E468743
Nominal voltage UN		600 V	
Nominal current IN		10 A	
mm ² /AWG/kcmil		16	

EAC-RoHS		RU D- DE.HB35.B.00387
----------	---	--------------------------

cULus Listed	
--------------	---

Accessories

Accessories

Protective cap

Power cable - SAC-6P-M12MRM/10,0-PUR PE SH - 1414946

Accessories

Sealing cap - PROT-M12 FS - 1560251



M12 sealing cap for unoccupied M12 plugs of the sensor/actuator cable, flush-type plugs and I/O devices in the field

Screwdriver tools

Tool - SAC BIT M12-D16 - 1200305



Nut for assembling sensor/actuator cables with M12 connector and M12 connectors for assembly, knurl diameter: 16 mm, for 4 mm hexagonal drive

Phoenix Contact 2020 © - all rights reserved
<http://www.phoenixcontact.com>

PHOENIX CONTACT GmbH & Co. KG
Flachsmarktstr. 8
32825 Blomberg
Germany
Tel. +49 5235 300
Fax +49 5235 3 41200
<http://www.phoenixcontact.com>

Mouser Electronics

Authorized Distributor

Click to View Pricing, Inventory, Delivery & Lifecycle Information:

[Phoenix Contact:](#)

[1414946](#)