

Power cable - SAC-6P-M12MRM/ 1,5-PVC PE SH - 1414935

Please be informed that the data shown in this PDF Document is generated from our Online Catalog. Please find the complete data in the user's documentation. Our General Terms of Use for Downloads are valid (<http://phoenixcontact.com/download>)



Power cable, 6-position, PVC, orange RAL 2003, shielded (Advanced Shielding Technology), Plug angled M12, coding: M, on free cable end, cable length: 1.5 m, For AC current up to 8 A/690 V

Your advantages

- ✓ Easy and safe: 100% electrically tested plug-in components
- ✓ High-performance: AC connectors for up to 8 A and 630 V AC
- ✓ Protection against mismatching, thanks to special M-coding
- ✓ Shield power reliably – 360° shielding to reduce electromagnetic loads



Key Commercial Data

Packing unit	1 pc
GTIN	
GTIN	4055626035635

Technical data

Dimensions

Length of cable	1.5 m
-----------------	-------

Ambient conditions

Ambient temperature (operation)	-25 °C ... 85 °C (Plug / socket)
Degree of protection	IP65
	IP67 (without preloading, as additional test in accordance with IEC 60529)

General

Rated current at 40°C	8 A
Rated voltage	690 V AC
Number of positions	6
Insulation resistance	≥ 100 MΩ
Coding	M - Power

Power cable - SAC-6P-M12MRM/ 1,5-PVC PE SH - 1414935

Technical data

General

Standards/regulations	M12 connector IEC 61076-2-111
Status display	No
Protective circuit/component	unwired
Overvoltage category	III
Degree of pollution	3
Torque	0.4 Nm (M12 connector)

Material

Flammability rating according to UL 94	V0
Contact material	CuZn
Contact surface material	Ni/Au
Contact carrier material	PA
Material of grip body	PP
Material, knurls	Zinc die-cast, nickel-plated

Standards and Regulations

Standards/specifications	M12 connector IEC 61076-2-111
Flammability rating according to UL 94	V0

Cable

UL AWM style	2570 / 10914 (80°C/1000 V)
Conductor cross section	6x 1.5 mm ²
AWG power supply	16
Conductor structure, voltage supply	78x 0.15 mm
Core diameter including insulation	2.4 mm ±0.05 mm
Thickness, insulation	≥ 0.36 mm
Wire colors	black 1, black 2, black 3, black 4, black 5, green/yellow
External sheath, color	orange RAL 2003
Outer sheath thickness	approx. 0.76 mm
External cable diameter D	10.4 mm ±0.25 mm
Minimum bending radius, fixed installation	5 x D
Minimum bending radius, flexible installation	10 x D
Number of bending cycles	1000000
Minimum bending radius, drag chain applications	10 x D
Traversing path	10 m
Traversing rate	3 m/s
Acceleration	10 m/s ²
Cable weight	192 kg/km
Outer sheath, material	PVC
Material conductor insulation	PVC
Conductor material	Bare Cu litz wires
Insulation resistance	≥ 100 MΩ*km (at 20 °C)

Power cable - SAC-6P-M12MRM/ 1,5-PVC PE SH - 1414935

Technical data

Cable

Conductor resistance	≤ 15 Ω/m (at 20 °C)
Nominal voltage, cable	≤ 1000 V AC
Test voltage, cable	≥ 10000 V AC (Spark test)
Flame resistance	According to UL 758/1581 (Cable Flame)
	according to UL 758/1581 FT1
	According to DIN EN 60332-1-2
Resistance to oil	According to DIN EN 60811-404, 168 h at 60 °C
Ambient temperature (operation)	-20 °C ... 80 °C (cable, flexible installation)

Environmental Product Compliance

REACH SVHC	Lead 7439-92-1
China RoHS	Environmentally Friendly Use Period = 50 years
	For details about hazardous substances go to tab "Downloads", Category "Manufacturer's declaration"

Drawings

Power cable - SAC-6P-M12MRM/ 1,5-PVC PE SH - 1414935

Dimensional drawing

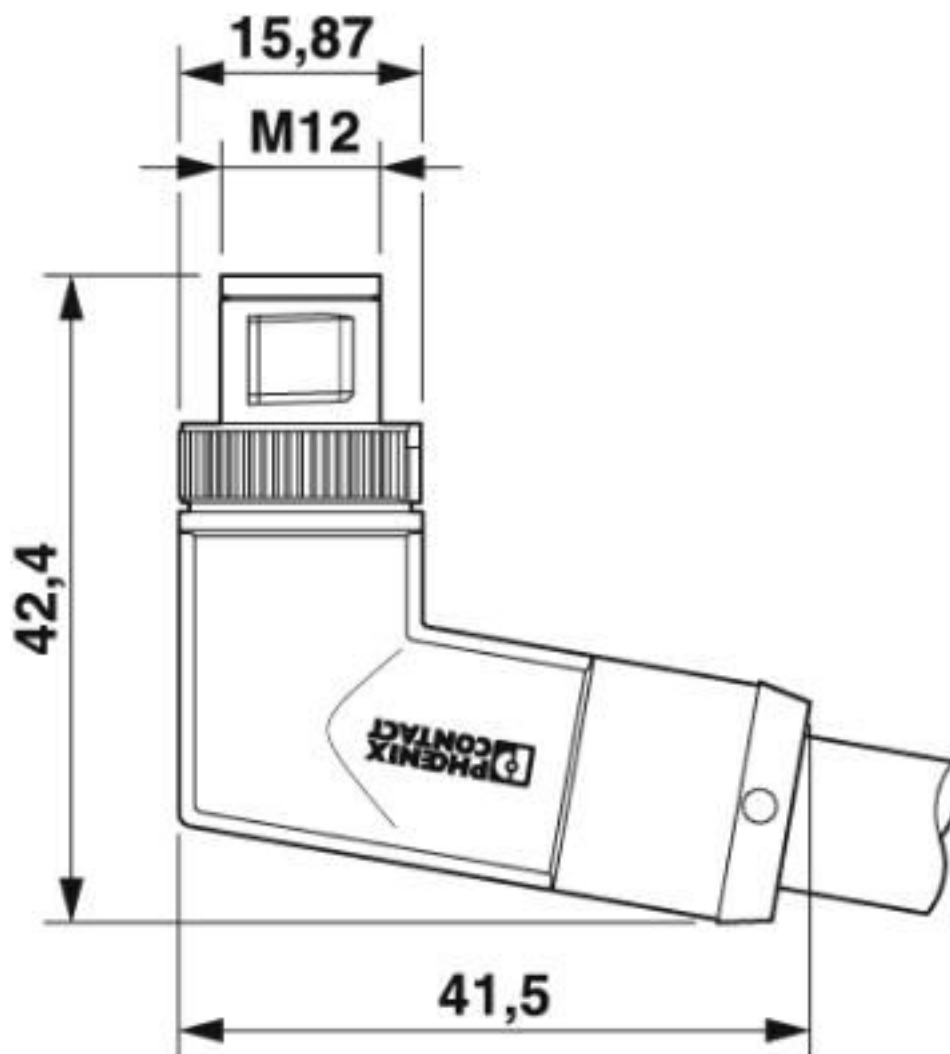

M12 x 1 male plug, angled

Power cable - SAC-6P-M12MRM/ 1,5-PVC PE SH - 1414935

Schematic diagram

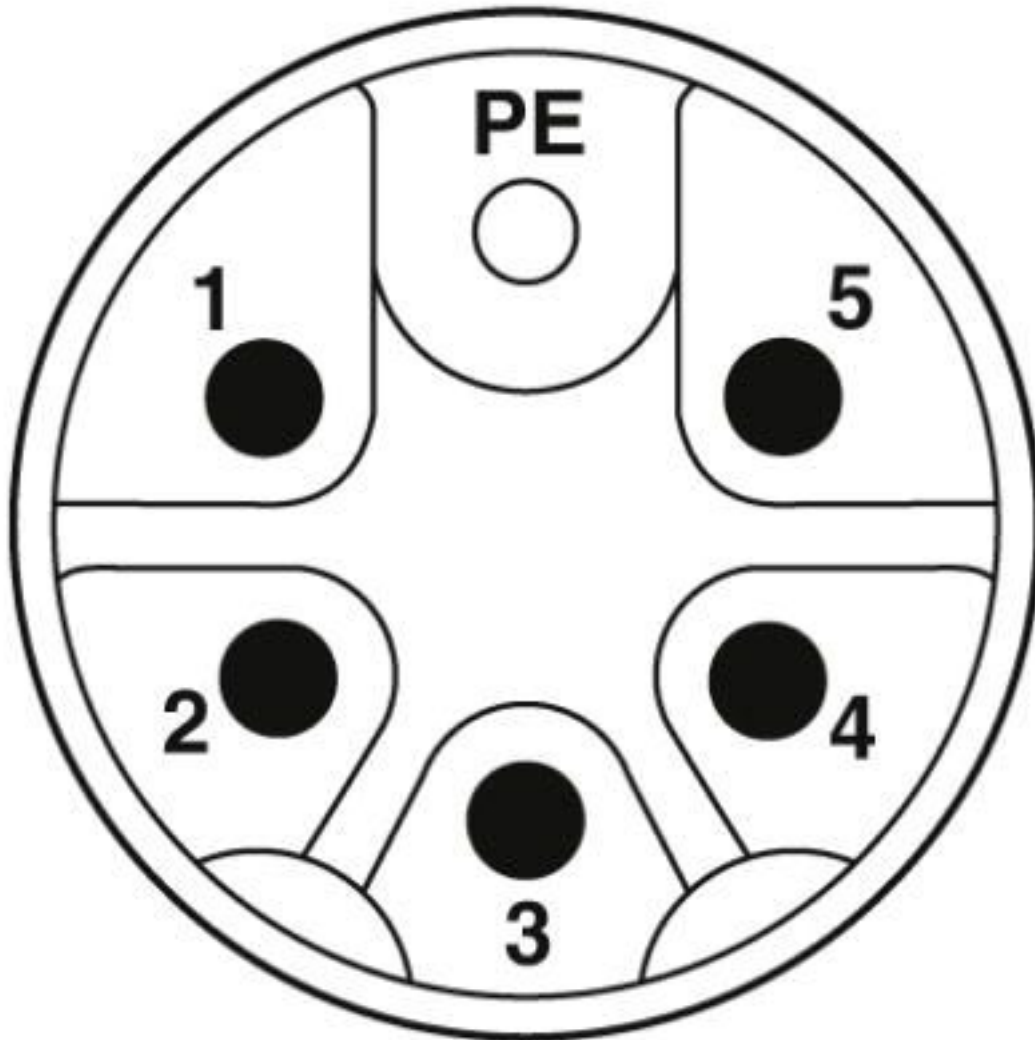

Pin assignment of M12 connector, 6-pos., M-coded, pin side view

Power cable - SAC-6P-M12MRM/ 1,5-PVC PE SH - 1414935

Diagram

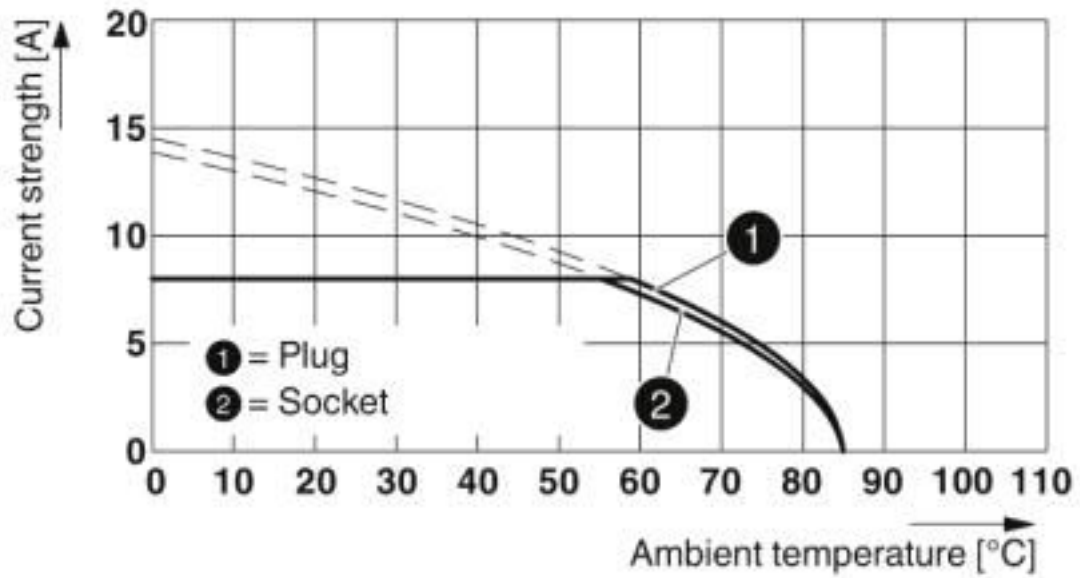

Current carrying capacity

Circuit diagram

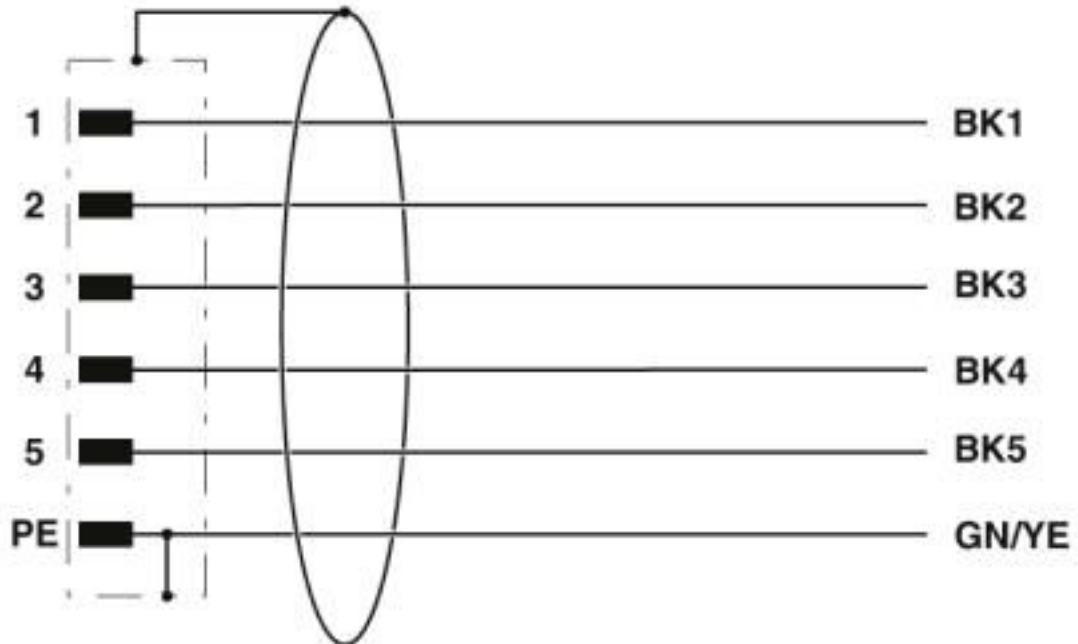

Contact assignment of the M12 plug

Power cable - SAC-6P-M12MRM/ 1,5-PVC PE SH - 1414935

Cable cross section

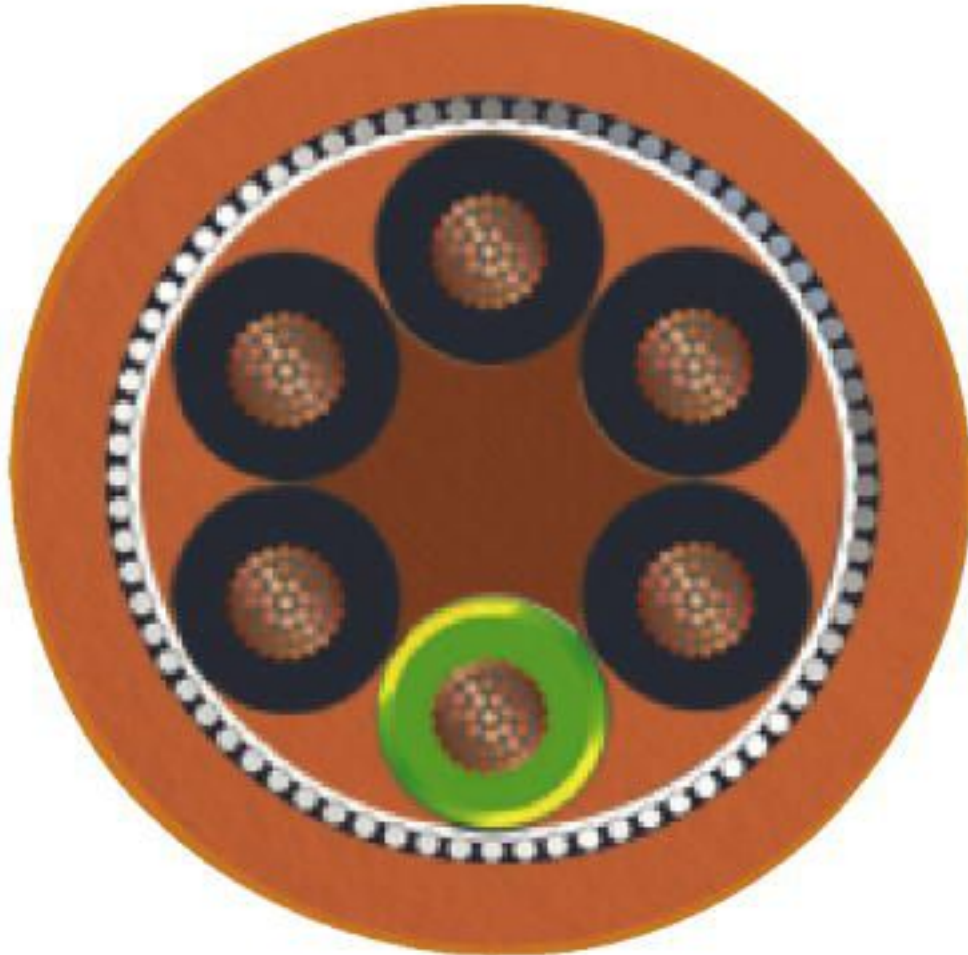

PVC orange [PVC]

Classifications

eCl@ss

eCl@ss 10.0.1	27060311
eCl@ss 5.1	27061801
eCl@ss 6.0	27279200
eCl@ss 7.0	27279218
eCl@ss 8.0	27279218
eCl@ss 9.0	27060311

ETIM

ETIM 5.0	EC001855
ETIM 6.0	EC001855

Power cable - SAC-6P-M12MRM/ 1,5-PVC PE SH - 1414935

Classifications

ETIM

ETIM 7.0	EC001855
----------	----------

Approvals

Approvals

Approvals

UL Listed / cUL Listed / EAC / cULus Listed

Ex Approvals

Approval details

UL Listed		http://database.ul.com/cgi-bin/XYV/template/LISEXT/1FRAME/index.htm	E468743
Nominal voltage UN		600 V	
Nominal current IN		10 A	
mm ² /AWG/kcmil		16	

cUL Listed		http://database.ul.com/cgi-bin/XYV/template/LISEXT/1FRAME/index.htm	E468743
Nominal voltage UN		600 V	
Nominal current IN		10 A	
mm ² /AWG/kcmil		16	

EAC		RU C- DE.BL08.B.00286
-----	---	--------------------------

cULus Listed	
--------------	---

Accessories

Accessories

Protective cap

Power cable - SAC-6P-M12MRM/ 1,5-PVC PE SH - 1414935

Accessories

Sealing cap - PROT-M12 FS - 1560251



M12 sealing cap for unoccupied M12 plugs of the sensor/actuator cable, flush-type plugs and I/O devices in the field

Screwdriver tools

Tool - SAC BIT M12-D16 - 1200305



Nut for assembling sensor/actuator cables with M12 connector and M12 connectors for assembly, knurl diameter: 16 mm, for 4 mm hexagonal drive

Phoenix Contact 2020 © - all rights reserved
<http://www.phoenixcontact.com>

PHOENIX CONTACT GmbH & Co. KG
Flachsmarktstr. 8
32825 Blomberg
Germany
Tel. +49 5235 300
Fax +49 5235 3 41200
<http://www.phoenixcontact.com>

Mouser Electronics

Authorized Distributor

Click to View Pricing, Inventory, Delivery & Lifecycle Information:

[Phoenix Contact:](#)

[1414935](#)