

# Printed-circuit board connector - MC 0,5/16-G-2,54 P20THRR56C1 - 1706208

Please be informed that the data shown in this PDF Document is generated from our Online Catalog. Please find the complete data in the user's documentation. Our General Terms of Use for Downloads are valid (<http://phoenixcontact.com/download>)

PCB headers, nominal current: 6 A, rated voltage (III/2): 160 V, nominal cross section: 0.5 mm<sup>2</sup>, number of positions: 16, pitch: 2.54 mm, color: black, contact surface: Gold, mounting: THR soldering, pin layout: Linear pinning, solder pin [P]: 2 mm, Fixed coding of the first position, can be combined with the FMC 0,5/...-ST-2,54 C1 connector



The figure shows the 10-position version

## Your advantages

- Designed for integration into the SMT soldering process
- Additional solder anchors reduce the mechanical strain on the soldering spots
- Gold-plated contacts ensure transfer quality remains stable over the long term
- Supplied in tape-on-reel packing according to IEC 60286-3 for automated mounting



## Key Commercial Data

Packing unit	465 pc
Minimum order quantity	465 pc
GTIN	
GTIN	4046356841542

## Technical data

### Dimensions

Length [ l ]	7.1 mm
Width	45.18 mm
Pitch	2.54 mm
Dimension a	38.1 mm
Width [ w ]	45.18 mm
Height [ h ]	6.85 mm
Installed height	4.85 mm
Length of the solder pin	2 mm
Pin dimensions	0.64 x 0.64 mm

# Printed-circuit board connector - MC 0,5/16-G-2,54 P20THRR56C1 - 1706208

## Technical data

### Dimensions

Length	7.1 mm
--------	--------

### General

Range of articles	MC 0,5/...G-THR
Insulating material group	IIIa
Rated surge voltage (III/3)	2.5 kV
Rated surge voltage (III/2)	2.5 kV
Rated surge voltage (II/2)	2.5 kV
Rated voltage (III/3)	32 V
Rated voltage (III/2)	160 V
Rated voltage (II/2)	160 V
Connection in acc. with standard	EN-VDE
Nominal current I <sub>N</sub>	6 A
Insulating material	LCP
Flammability rating according to UL 94	V0
Color	black
Number of positions	16

### Standards and Regulations

Connection in acc. with standard	EN-VDE
Flammability rating according to UL 94	V0

### Environmental Product Compliance

China RoHS	Environmentally friendly use period: unlimited = EFUP-e
	No hazardous substances above threshold values

## Drawings

# Printed-circuit board connector - MC 0,5/16-G-2,54 P20THRR56C1 - 1706208

Drilling diagram

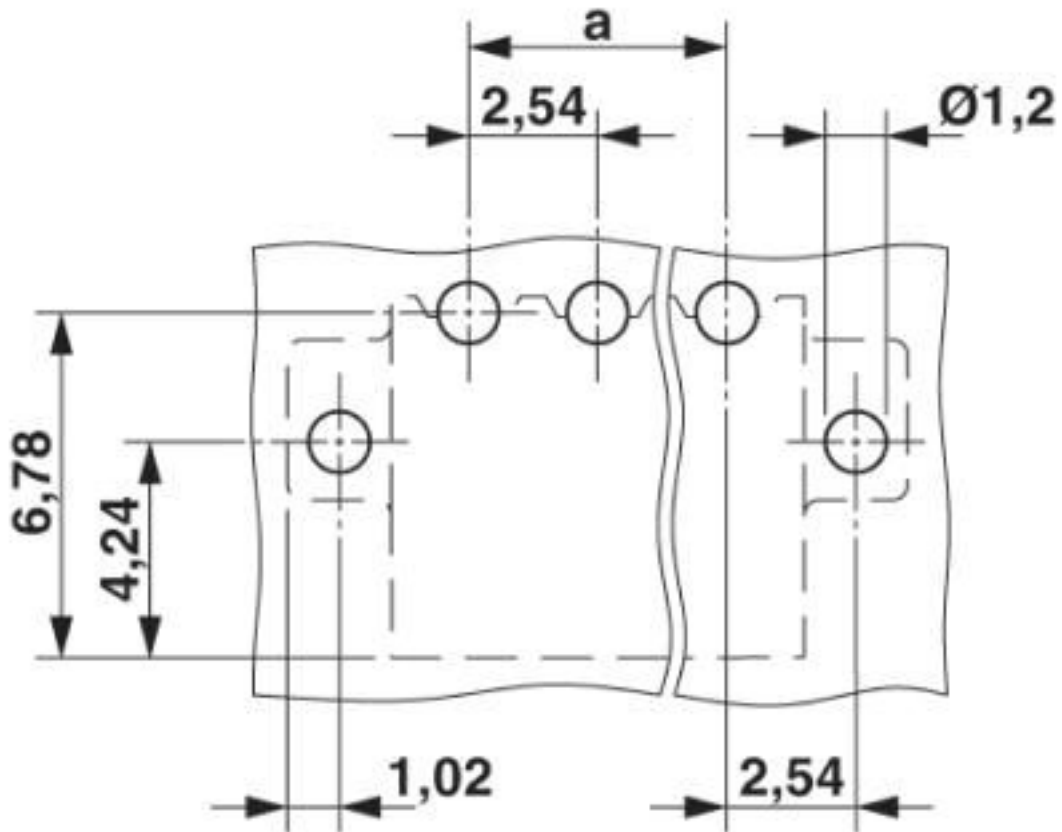

# Printed-circuit board connector - MC 0,5/16-G-2,54 P20THRR56C1 - 1706208

Diagram

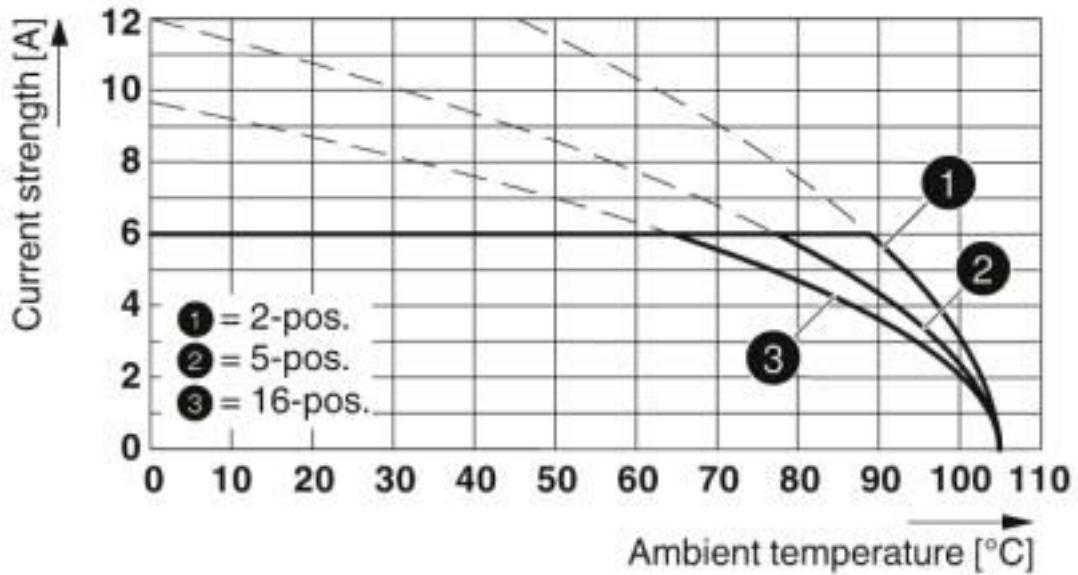

Type: MCC 0,5/...-ST-2,54 with MC 0,5/...-G-2,54 P20 THR R...

Diagram

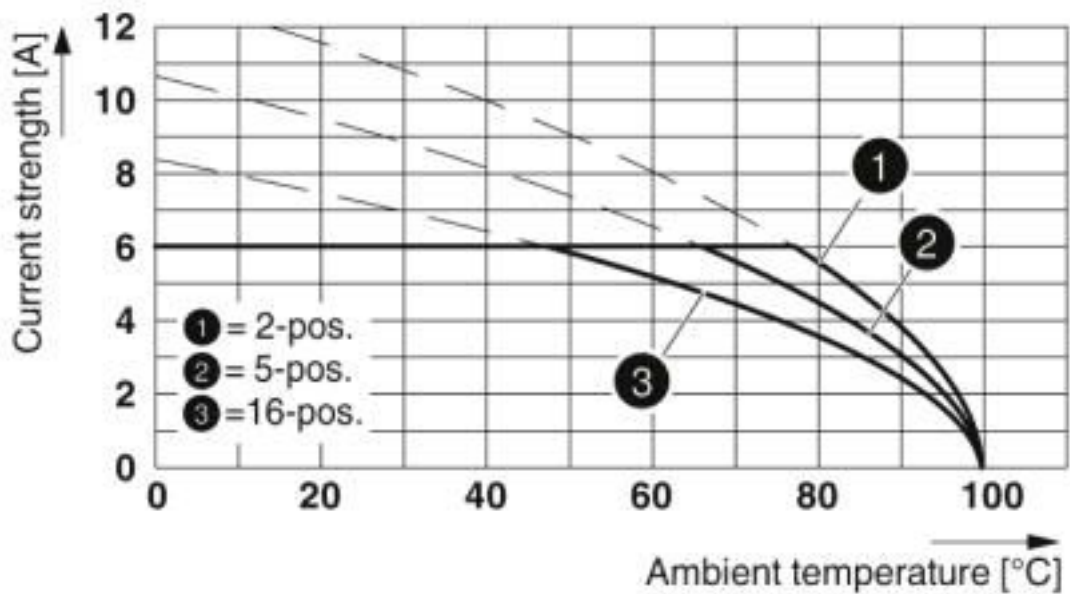

Type: FMC 0,5/...-ST-2,54 with MC 0,5/...-G-2,54 P20 THR R..

# Printed-circuit board connector - MC 0,5/16-G-2,54 P20THRR56C1 - 1706208

Dimensional drawing

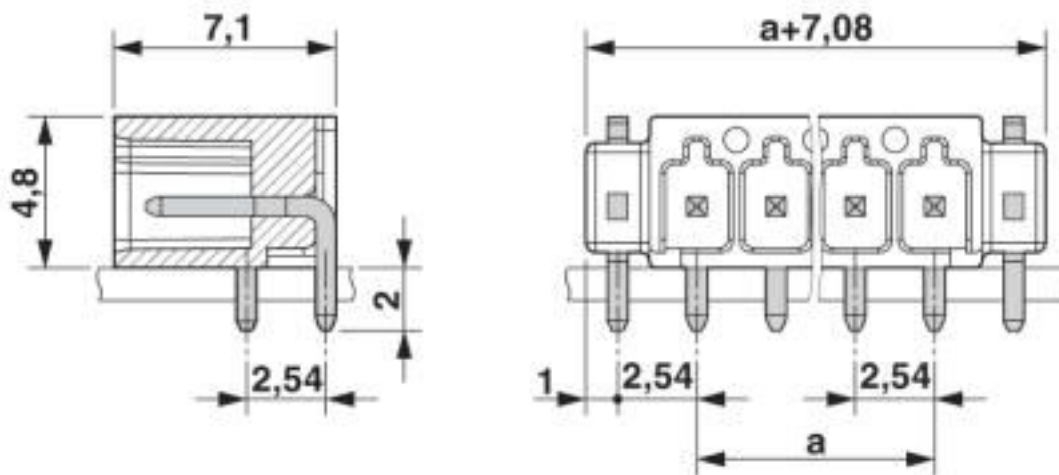

## Classifications

eCl@ss

eCl@ss 10.0.1	27440402
eCl@ss 4.0	27260700
eCl@ss 4.1	27260700
eCl@ss 5.0	27260700
eCl@ss 5.1	27260700
eCl@ss 6.0	27260700
eCl@ss 7.0	27440402
eCl@ss 8.0	27440402
eCl@ss 9.0	27440402

ETIM

ETIM 3.0	EC001121
ETIM 4.0	EC002637
ETIM 5.0	EC002637
ETIM 6.0	EC002637
ETIM 7.0	EC002637

UNSPSC

UNSPSC 6.01	30211810
UNSPSC 7.0901	39121409
UNSPSC 11	39121409
UNSPSC 12.01	39121409
UNSPSC 13.2	39121409
UNSPSC 18.0	39121409
UNSPSC 19.0	39121409

# Printed-circuit board connector - MC 0,5/16-G-2,54 P20THRR56C1 - 1706208

## Classifications

### UNSPSC

UNSPSC 20.0	39121409
UNSPSC 21.0	39121409

## Approvals

### Approvals

#### Approvals

IECEE CB Scheme / VDE Gutachten mit Fertigungsüberwachung / EAC / cULus Recognized

#### Ex Approvals

### Approval details

IECEE CB Scheme		<a href="http://www.iecee.org/">http://www.iecee.org/</a>	DE1-63595
Nominal voltage UN	160 V		
Nominal current IN	6 A		

VDE Gutachten mit Fertigungsüberwachung		<a href="http://www2.vde.com/de/Institut/Online-Service/VDE-gepruefteProdukte/Seiten/Online-Suche.aspx">http://www2.vde.com/de/Institut/Online-Service/VDE-gepruefteProdukte/Seiten/Online-Suche.aspx</a>	40042258
Nominal voltage UN	160 V		
Nominal current IN	6 A		

EAC		B.01687
-----	---	---------

cULus Recognized		<a href="http://database.ul.com/cgi-bin/XYVV/template/LISEXT/1FRAME/index.htm">http://database.ul.com/cgi-bin/XYVV/template/LISEXT/1FRAME/index.htm</a>	E60425-19920306
Nominal voltage UN	B 150 V	C 50 V	
Nominal current IN	6 A	6 A	

## Printed-circuit board connector - MC 0,5/16-G-2,54 P20THRR56C1 - 1706208

### Accessories

#### Accessories

##### Labeled terminal marker

Marker card - SK 2,54/2,8:FORTL.ZAHLEN - 0804853



Marker card, Card, white, labeled, horizontal: consecutive numbers 1 ... 10, 11 ... 20, etc. up to 91 ... 99, mounting type: adhesive, for terminal block width: 2.54 mm, lettering field size: 2.54 x 2.8 mm

---

### Additional products

Printed-circuit board connector - FMC 0,5/16-ST-2,54 C1 - 1706245



PCB connector, nominal current: 6 A, rated voltage (III/2): 160 V, nominal cross section: 0.5 mm<sup>2</sup>, number of positions: 16, pitch: 2.54 mm, connection method: Push-in spring connection, color: black, contact surface: Gold, Fixed coding of the first position, can be combined with MC(V) 0,5/...-G-2,54...C1 headers

---

Phoenix Contact 2020 © - all rights reserved  
<http://www.phoenixcontact.com>

PHOENIX CONTACT GmbH & Co. KG  
Flachsmarktstr. 8  
32825 Blomberg  
Germany  
Tel. +49 5235 300  
Fax +49 5235 3 41200  
<http://www.phoenixcontact.com>

# Mouser Electronics

Authorized Distributor

Click to View Pricing, Inventory, Delivery & Lifecycle Information:

[Phoenix Contact:](#)

[1706208](#)