

## Power cable - SAC-4P-M12MRL/10,0-105 - 1425032

Please be informed that the data shown in this PDF Document is generated from our Online Catalog. Please find the complete data in the user's documentation. Our General Terms of Use for Downloads are valid (<http://phoenixcontact.com/download>)



Power cable, 4-position, PUR halogen-free, black-gray RAL 7021, Plug angled M12, coding: L, on free cable end, cable length: 10 m, For direct current up to 12 A/63 V

### Your advantages

- ✓ Easy and safe: 100% electrically tested plug-in components
- ✓ High-performance: DC connectors for up to 12 A and 63 V DC
- ✓ Protection against mismatching, thanks to special L-coding
- ✓ Our standard: robust halogen-free PUR cable

### Key Commercial Data

Packing unit	1 pc
GTIN	 4 055626 383705
GTIN	4055626383705

### Technical data

#### Dimensions

Length of cable	10 m
-----------------	------

#### Ambient conditions

Ambient temperature (operation)	-25 °C ... 85 °C (Plug / socket)
Degree of protection	IP65
	IP67

#### General

Rated current at 40°C	12 A
Rated voltage	63 V DC
Number of positions	4
Color handle area	black
Insulation resistance	≥ 100 MΩ

# Power cable - SAC-4P-M12MRL/10,0-105 - 1425032

## Technical data

### General

Coding	L - Power
Standards/regulations	M12 connector IEC 61076-2-111
Status display	No
Protective circuit/component	unwired
Overvoltage category	III
Degree of pollution	3
Insertion/withdrawal cycles	≥ 100
Torque	0.4 Nm (M12 connector)

### Material

Flammability rating according to UL 94	V0
Contact material	CuZn
Contact surface material	Ni/Au
Contact carrier material	PA
Material of grip body	PP
Material, knurls	Zinc die-cast, nickel-plated

### Standards and Regulations

Standards/specifications	M12 connector IEC 61076-2-111
Flammability rating according to UL 94	V0

### Cable

Cable type	PUR halogen-free black
Cable type (abbreviation)	PUR
Cable abbreviation	Li9YV1-11Y
UL AWM style	20233 / 10493 (80°C/300 V)
Conductor cross section	4x 1.5 mm <sup>2</sup>
AWG power supply	16
Conductor structure, voltage supply	78x 0.15 mm
Core diameter including insulation	2.35 mm ±0.05 mm
Thickness, insulation	≥ 0.25 mm
Wire colors	brown, white, blue, black
Overall twist	4 wires, twisted
Length of twist, overall twist	90 mm
External sheath, color	black-gray RAL 7021
Outer sheath thickness	approx. 1.3 mm
External cable diameter D	8.4 mm ±0.25 mm
Minimum bending radius, fixed installation	5 x D
Minimum bending radius, flexible installation	10 x D
Number of bending cycles	4000000
Minimum bending radius, drag chain applications	10 x D
Traversing path	10 m

## Power cable - SAC-4P-M12MRL/10,0-105 - 1425032

### Technical data

#### Cable

Traversing rate	3 m/s
Acceleration	10 m/s <sup>2</sup>
Cable weight	109 kg/km
Outer sheath, material	PUR
Material conductor insulation	PP
Conductor material	Bare Cu litz wires
Insulation resistance	≥ 1 GΩ*km (at 20 °C)
Conductor resistance	≤ 13 Ω/km (at 20 °C)
Nominal voltage, cable	≤ 300 V AC
Test voltage, cable	≥ 3000 V AC (Spark test)
Flame resistance	According to UL 758/1581 (Cable Flame)
	according to UL 758/1581 FT1
	According to DIN EN 60332-1-2
Halogen-free	in accordance with DIN VDE 0472 part 815
	in accordance with DIN EN 50267-2-1
Resistance to oil	According to DIN EN 60811-2-1, 168 h at 100°C
	According to UL 758, 168 h at 60°C
Other resistance	Hydrolysis and microbe resistant as per VDE 0282 section 10
	Low adhesion
	abrasion-resistant
	Resistant to salt water
Ambient temperature (operation)	-50 °C ... 80 °C (cable, fixed installation)
	-30 °C ... 80 °C (cable, flexible installation)

#### Environmental Product Compliance

REACH SVHC	Lead 7439-92-1
China RoHS	Environmentally Friendly Use Period = 50 years
	For details about hazardous substances go to tab "Downloads", Category "Manufacturer's declaration"

#### Drawings

# Power cable - SAC-4P-M12MRL/10,0-105 - 1425032

Dimensional drawing

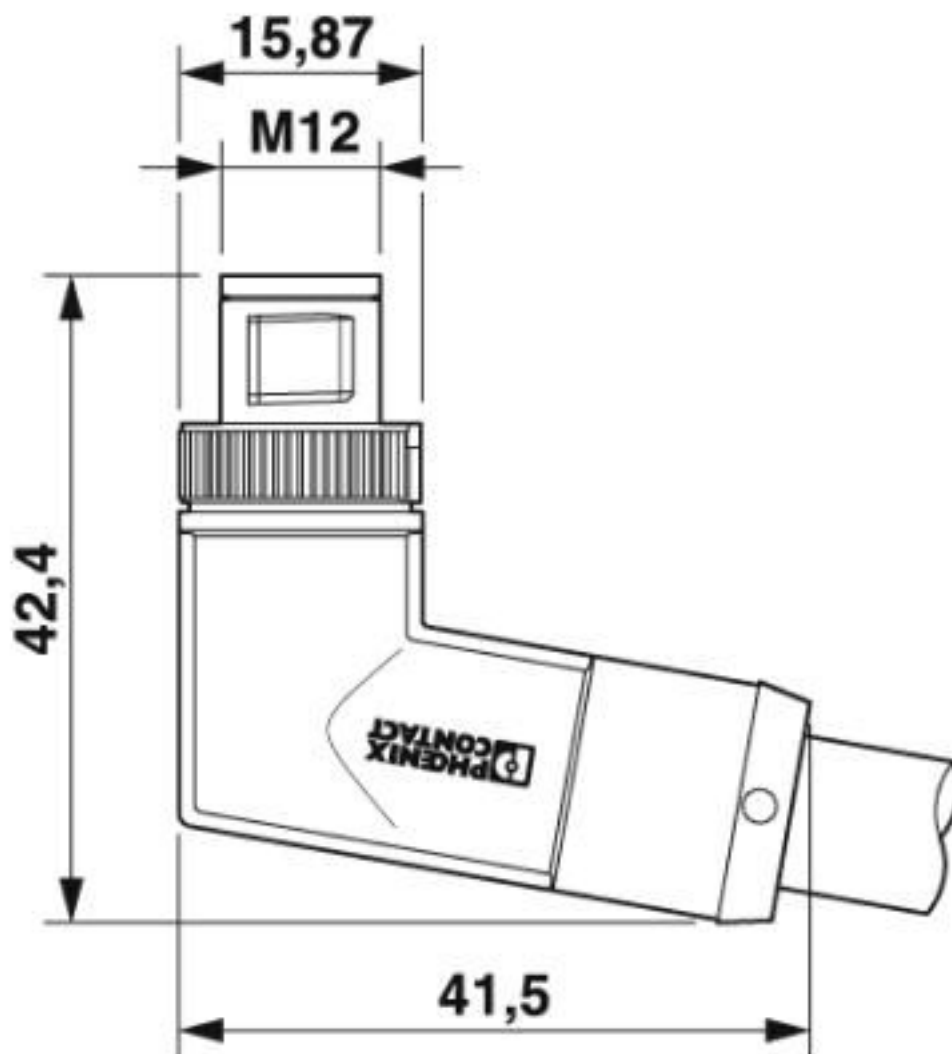

M12 x 1 male plug, angled

## Power cable - SAC-4P-M12MRL/10,0-105 - 1425032

Schematic diagram

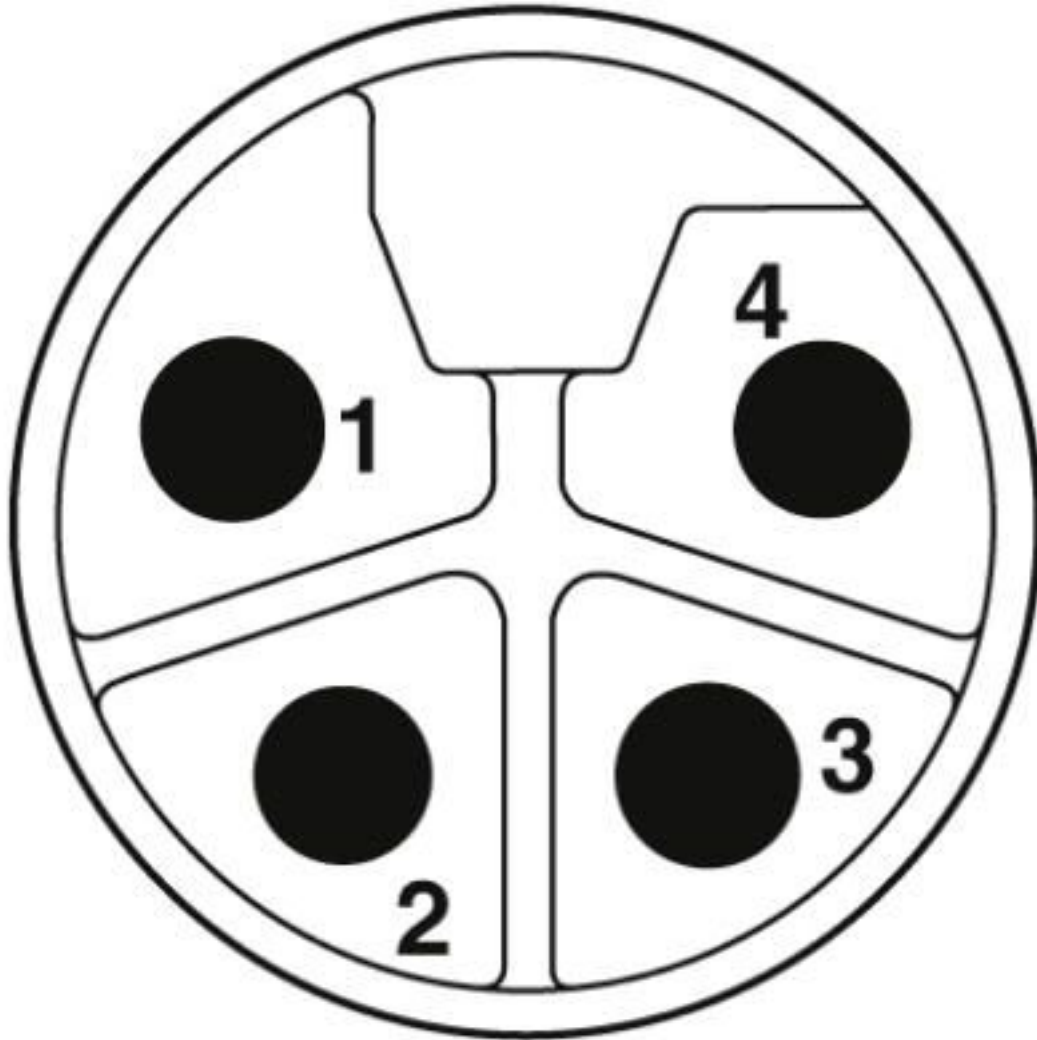

Pin assignment M12 male connector, 4-pos.

# Power cable - SAC-4P-M12MRL/10,0-105 - 1425032

Diagram

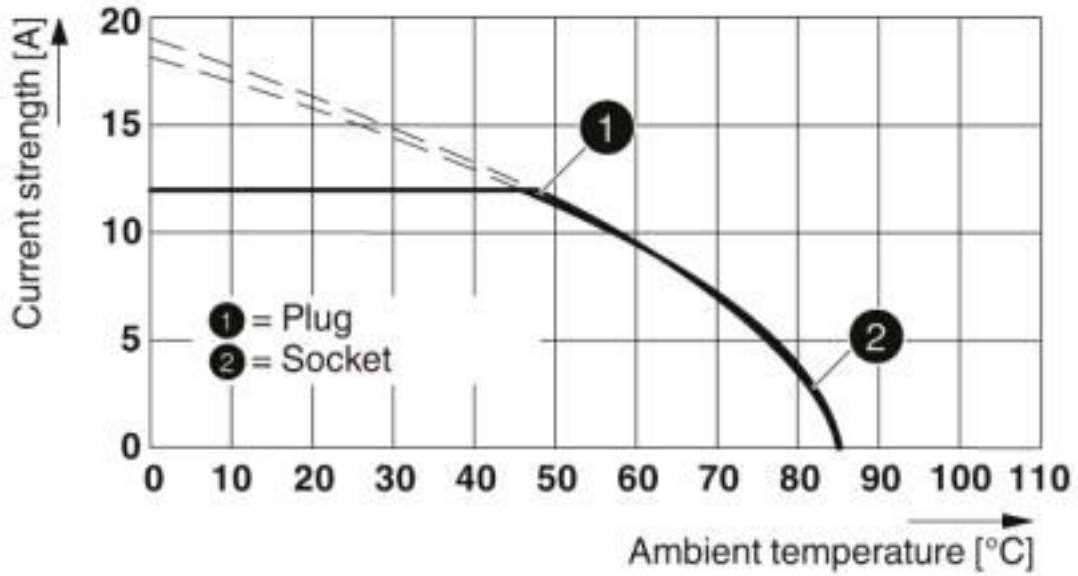

Circuit diagram

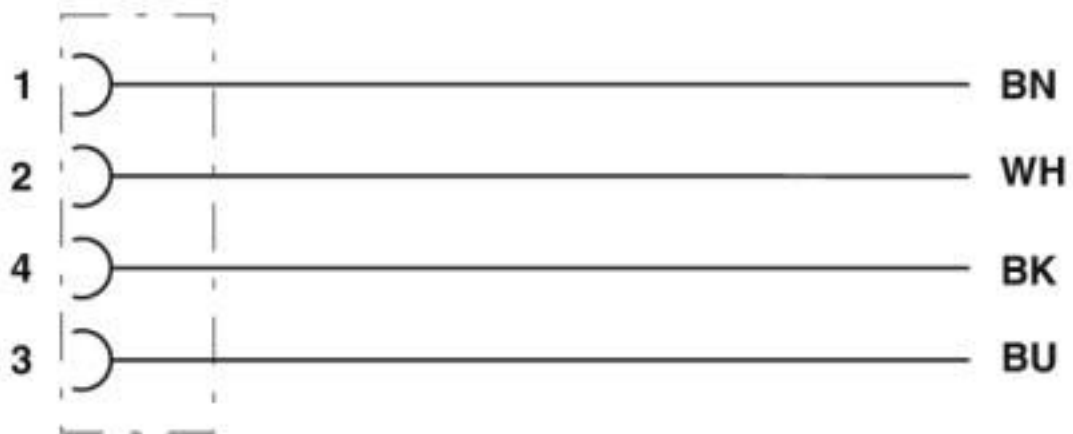

Contact assignment of the M12 plug

# Power cable - SAC-4P-M12MRL/10,0-105 - 1425032

Cable cross section

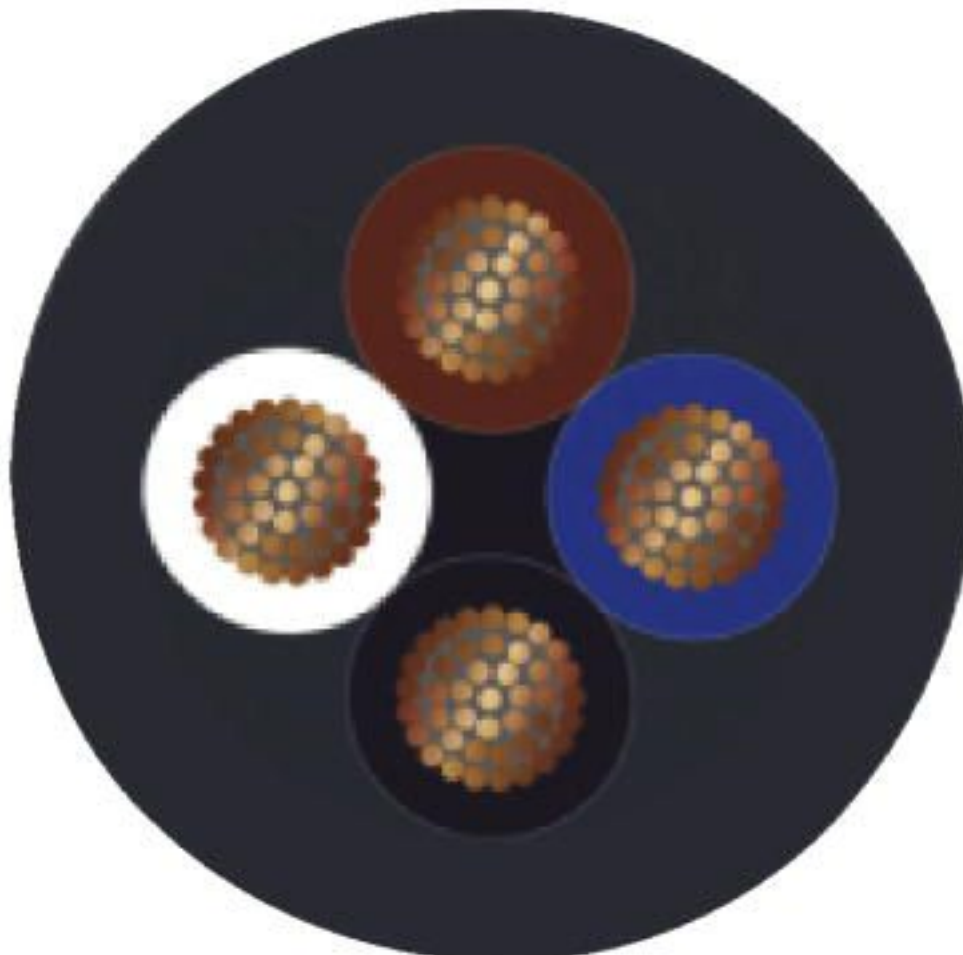

PUR halogen-free black [PUR]

## Classifications

eCl@ss

eCl@ss 10.0.1	27060311
eCl@ss 5.1	27061801
eCl@ss 6.0	27279200
eCl@ss 7.0	27279218
eCl@ss 9.0	27060311

ETIM

ETIM 5.0	EC001855
ETIM 6.0	EC001855
ETIM 7.0	EC001855

# Power cable - SAC-4P-M12MRL/10,0-105 - 1425032

## Approvals

### Approvals

#### Approvals

UL Listed / cUL Listed / EAC-RoHS / EAC / cULus Listed

#### Ex Approvals

### Approval details

UL Listed		<a href="http://database.ul.com/cgi-bin/XYV/template/LISEXT/1FRAME/index.htm">http://database.ul.com/cgi-bin/XYV/template/LISEXT/1FRAME/index.htm</a>	E468743
Nominal voltage UN	63 V		
Nominal current IN	16 A		
mm <sup>2</sup> /AWG/kcmil	14		

cUL Listed		<a href="http://database.ul.com/cgi-bin/XYV/template/LISEXT/1FRAME/index.htm">http://database.ul.com/cgi-bin/XYV/template/LISEXT/1FRAME/index.htm</a>	E468743
Nominal voltage UN	63 V		
Nominal current IN	16 A		
mm <sup>2</sup> /AWG/kcmil	14		

EAC-RoHS		RU D- DE.HB35.B.00387
----------	---	--------------------------

EAC		RU C- DE.BL08.B.00286
-----	---	--------------------------

cULus Listed		
--------------	---	--

## Accessories

### Accessories

Protective cap



## Power cable - SAC-4P-M12MRL/10,0-105 - 1425032

### Accessories

Sealing cap - PROT-M12 FS - 1560251



M12 sealing cap for unoccupied M12 plugs of the sensor/actuator cable, flush-type plugs and I/O devices in the field

---

### Screwdriver tools

Tool - SAC BIT M12-D16 - 1200305



Nut for assembling sensor/actuator cables with M12 connector and M12 connectors for assembly, knurl diameter: 16 mm, for 4 mm hexagonal drive

---

Phoenix Contact 2020 © - all rights reserved  
<http://www.phoenixcontact.com>

PHOENIX CONTACT GmbH & Co. KG  
Flachsmarktstr. 8  
32825 Blomberg  
Germany  
Tel. +49 5235 300  
Fax +49 5235 3 41200  
<http://www.phoenixcontact.com>

# Mouser Electronics

Authorized Distributor

Click to View Pricing, Inventory, Delivery & Lifecycle Information:

[Phoenix Contact:](#)

[1425032](#)