

Sensor/actuator cable - SAC-12P-MS/ 3,0-35T/FS SH SCO - 1402551

Please be informed that the data shown in this PDF Document is generated from our Online Catalog. Please find the complete data in the user's documentation. Our General Terms of Use for Downloads are valid (<http://phoenixcontact.com/download>)



Sensor/actuator cable, 12-position, PUR/PVC, black RAL 9005, shielded, Plug straight M12 SPEEDCON, coding: A, on Socket straight M12 SPEEDCON, coding: A, cable length: 3 m

Your advantages

- ✓ Easy and safe: 100% electrically tested plug-in components
- ✓ Save time, thanks to installation with SPEEDCON fast locking system
- ✓ Save space – with high-pos. connectors
- ✓ Reliable signal transmission – 360° shielding in environments with electromagnetic interference



Key Commercial Data

Packing unit	1 pc
GTIN	 4 046356 622615
GTIN	4046356622615

Technical data

Dimensions

Length of cable	3 m
Stripping length of the free conductor end	35 mm

Ambient conditions

Ambient temperature (operation)	-25 °C ... 85 °C (Plug / socket)
Degree of protection	IP65
	IP67

General

Rated current at 40°C	1.5 A
Rated voltage	30 V AC
	30 V DC
Number of positions	12

Sensor/actuator cable - SAC-12P-MS/ 3,0-35T/FS SH SCO - 1402551

Technical data

General

Insulation resistance	≥ 100 MΩ
Coding	A - standard
Status display	No
Protective circuit/component	unwired
Overvoltage category	II
Degree of pollution	3
Insertion/withdrawal cycles	≥ 100

Material

Flammability rating according to UL 94	V0
Contact material	CuZn
Contact surface material	Ni/Au
Contact carrier material	PA 6.6
Material of grip body	TPU, hardly inflammable, self-extinguishing
Material, knurls	Zinc die-cast, nickel-plated
Sealing material	NBR

Standards and Regulations

Flame resistance	DIN VDE 0472 part 804, test type B
Resistance to oil	DIN VDE 0472 Part 803, test type B
Other resistance	Hydrolysis and microbe resistant as per VDE 0282 section 10
Flammability rating according to UL 94	V0

Cable

Cable type	Black PUR/PVC twisted pair
Cable type (abbreviation)	35T
Cable abbreviation	LSPYwC11Y
UL AWM style	20233 / 1061 (80°C/300 V)
Conductor cross section	12x 0.14 mm ² (Signal line)
AWG signal line	26
Conductor structure signal line	18x 0.10 mm
Core diameter including insulation	1 mm ±0.05 mm (Signal line)
Wire colors	White-brown, green-yellow, gray-pink, blue-red, black-violet, gray/pink-red/blue
Twisted pairs	2 cores to the pair
Overall twist	Six pairs around the filler to the core
Shielding	Tinned copper braided shield
Optical shield covering	85 %
External sheath, color	black RAL 9005
External cable diameter D	8.5 mm ±0.2 mm
Minimum bending radius, fixed installation	5 x D
Minimum bending radius, flexible installation	10 x D
Number of bending cycles	2000000

Sensor/actuator cable - SAC-12P-MS/ 3,0-35T/FS SH SCO - 1402551

Technical data

Cable

Bending radius	85 mm
Traversing path	10 m
Traversing rate	3 m/s
Acceleration	10 m/s ²
Cable weight	87 kg/km
Outer sheath, material	PUR
Material, inner sheath	PVC
Material conductor insulation	PVC
Conductor material	Tin-plated Cu litz wires
Insulation resistance	≥ 10 MΩ*km (at 20 °C)
Conductor resistance	≤ 142 Ω/km (at 20 °C)
Nominal voltage, cable	42 V AC
Test voltage, cable	1500 V AC
Special properties	Flexible cable conduit capable
Flame resistance	According to DIN EN 60332-1-2
	According to VW-1
Resistance to oil	in accordance with DIN EN 60811-2-1
Other resistance	hydrolysis and microbe resistant according to EN 50396
Ambient temperature (operation)	-30 °C ... 80 °C (cable, fixed installation)
	-5 °C ... 80 °C (cable, flexible installation)

Environmental Product Compliance

REACH SVHC	Lead 7439-92-1
China RoHS	Environmentally Friendly Use Period = 50 years
	For details about hazardous substances go to tab "Downloads", Category "Manufacturer's declaration"

Drawings

Sensor/actuator cable - SAC-12P-MS/ 3,0-35T/FS SH SCO - 1402551

Schematic diagram

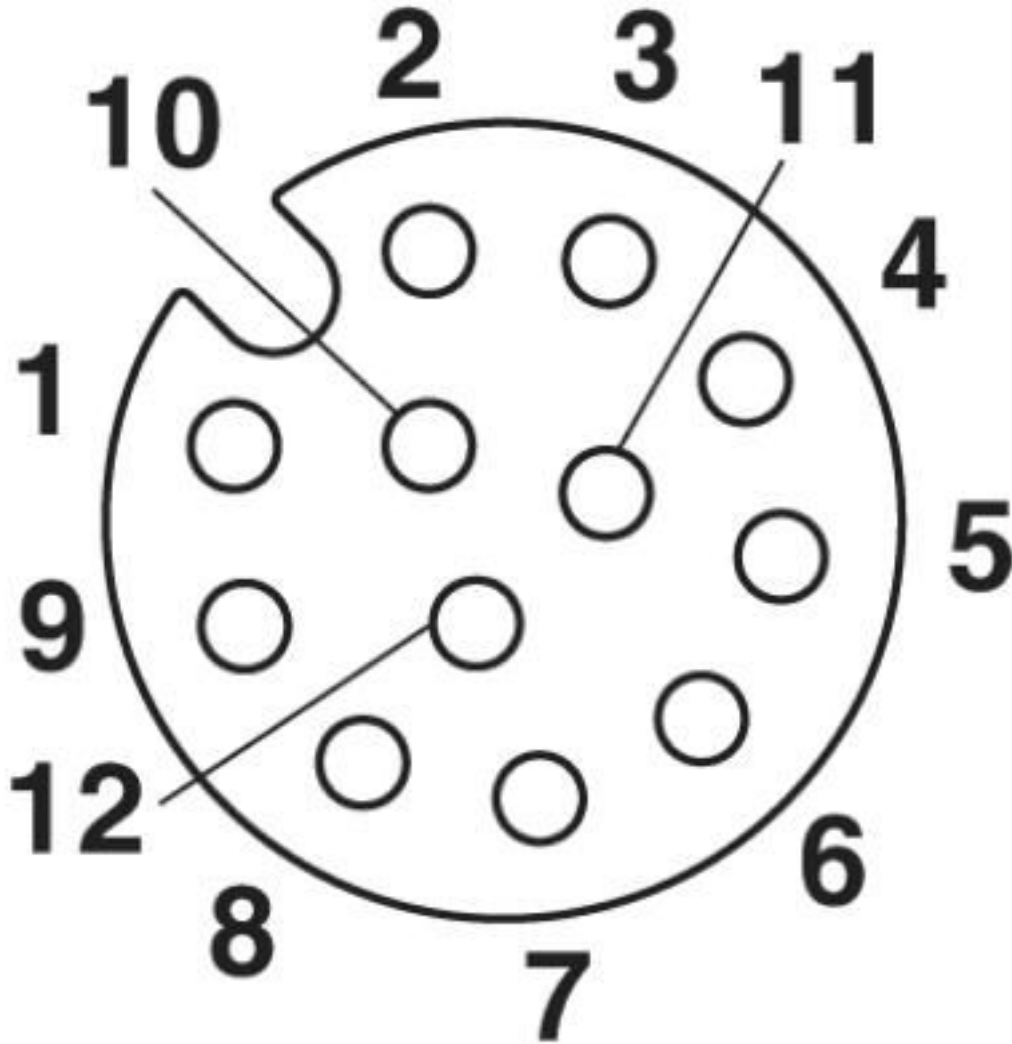

Pin assignment M12, 12-pos., female side view

Sensor/actuator cable - SAC-12P-MS/ 3,0-35T/FS SH SCO - 1402551

Schematic diagram

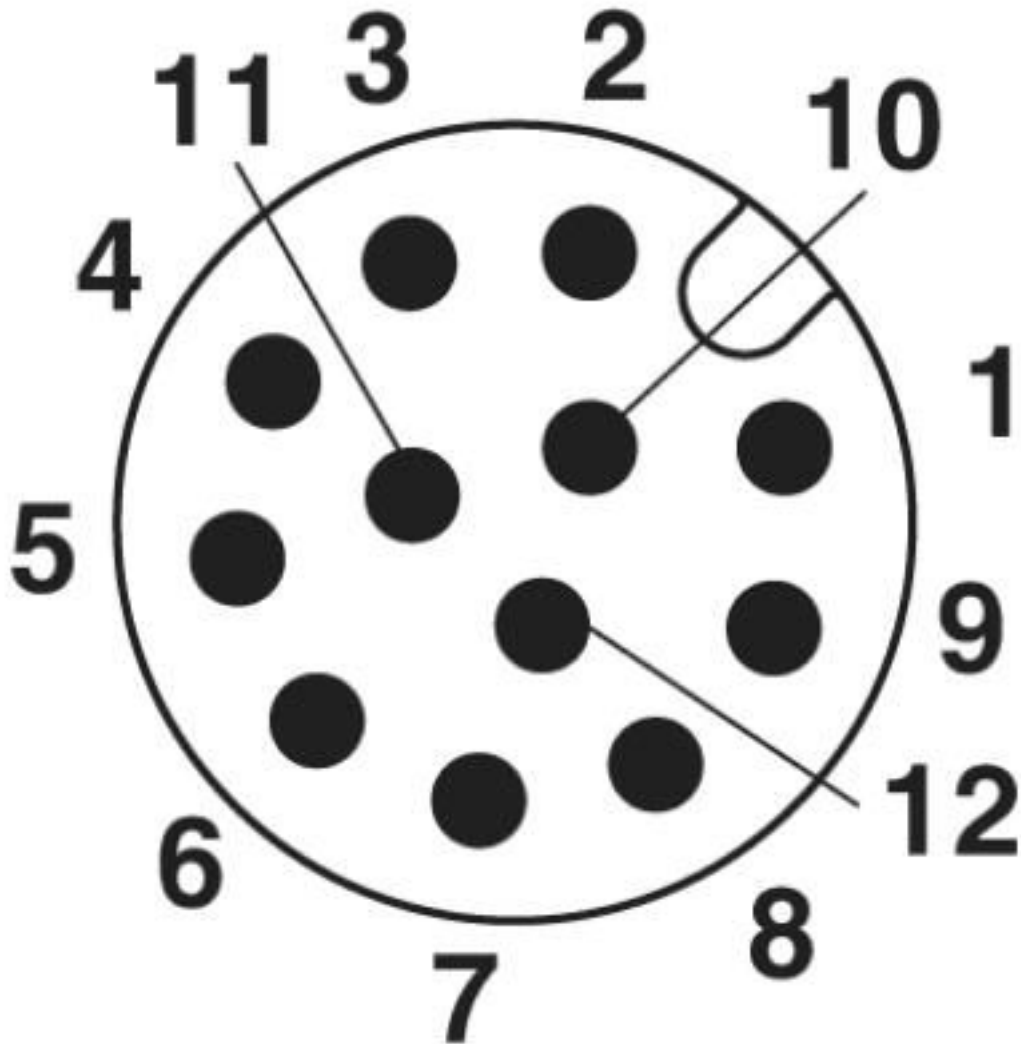

Pin assignment M12 male connector, 12-pos., male side view

Sensor/actuator cable - SAC-12P-MS/ 3,0-35T/FS SH SCO - 1402551

Dimensional drawing

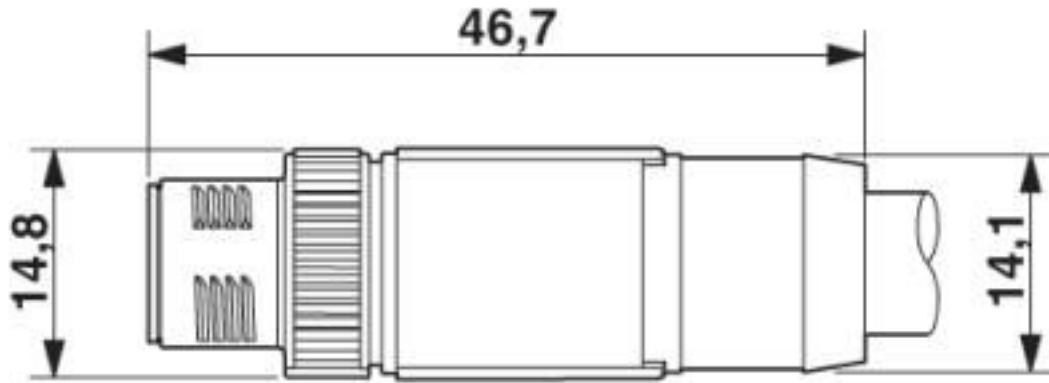

M12 SPEEDCON plug, straight, shielded

Dimensional drawing

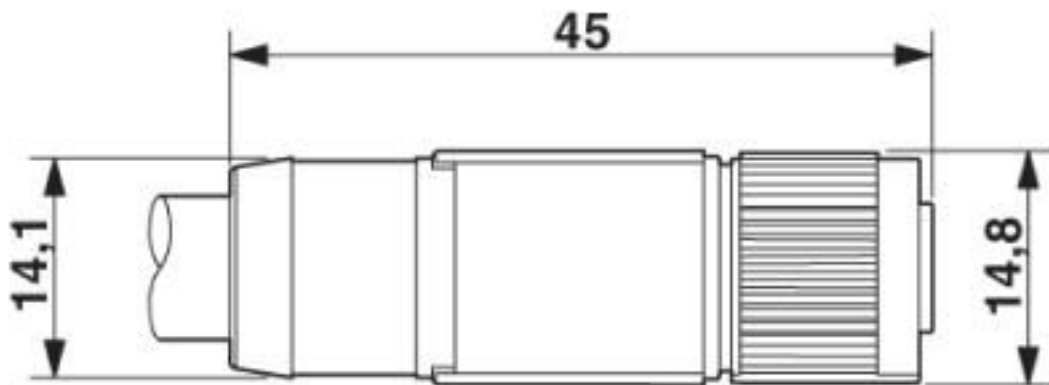

Socket M12-SPEEDCON, straight, shielded

Sensor/actuator cable - SAC-12P-MS/ 3,0-35T/FS SH SCO - 1402551

Circuit diagram

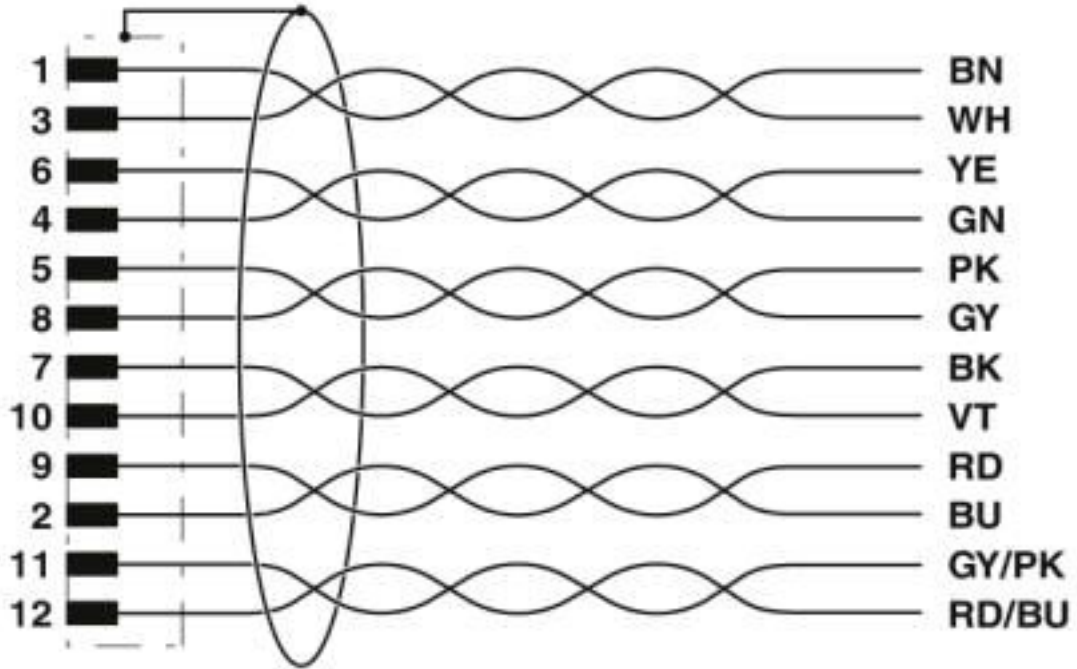

Contact assignment of the M12 plug

Sensor/actuator cable - SAC-12P-MS/ 3,0-35T/FS SH SCO - 1402551

Cable cross section



Black PUR/PVC twisted pair [35T]

Classifications

eCl@ss

eCl@ss 10.0.1	27060311
eCl@ss 4.0	27060300
eCl@ss 4.1	27060300
eCl@ss 5.0	27061800
eCl@ss 5.1	27061800
eCl@ss 6.0	27279200
eCl@ss 7.0	27279218
eCl@ss 8.0	27279218
eCl@ss 9.0	27060311

Sensor/actuator cable - SAC-12P-MS/ 3,0-35T/FS SH SCO - 1402551

Classifications

ETIM

ETIM 4.0	EC001855
ETIM 5.0	EC001855
ETIM 6.0	EC001855
ETIM 7.0	EC001855

UNSPSC

UNSPSC 6.01	31251501
UNSPSC 7.0901	31251501
UNSPSC 11	31251501
UNSPSC 12.01	31251501
UNSPSC 13.2	31251501
UNSPSC 19.0	31251501
UNSPSC 20.0	31251501
UNSPSC 21.0	31251501

Approvals

Approvals

Approvals

UL Listed / EAC-RoHS / EAC

Ex Approvals

Approval details

UL Listed		http://database.ul.com/cgi-bin/XYV/template/LISEXT/1FRAME/index.htm	FILE E 221474
Nominal voltage UN	30 V		
Nominal current IN	1 A		

EAC-RoHS		RU D- DE.HB35.B.00385
----------	---	--------------------------

EAC		RU C- DE.BL08.B.00286
-----	---	--------------------------

Sensor/actuator cable - SAC-12P-MS/ 3,0-35T/FS SH SCO - 1402551

Accessories

Accessories

Conductor marking

Insert label - PABA WH/23 - 1013779



Insert label, Strip, white, unlabeled, can be labeled with: CMS-P1-PLOTTER, mounting type: thread on, cable diameter range: 1.5 ... 35 mm, lettering field size: 23 x 4 mm, Number of individual labels: 20

Insert label - PABA YE/23 - 1013782



Insert label, Strip, yellow, unlabeled, can be labeled with: CMS-P1-PLOTTER, mounting type: thread on, cable diameter range: 1.5 ... 35 mm, lettering field size: 23 x 4 mm, Number of individual labels: 20

Marker pen

Marker pen - B-STIFT - 1051993



Marker pen, for manual labeling of unprinted Zack strips, smear-proof and waterproof, line thickness 0.5 mm

Plug for cable screw gland

Screw plug - PROT-M12 MS-PA-CHAIN - 1430899

M12 sealing cap with fixing band, for sensor cables, for free M12 sockets



Protective cap

Sealing cap - PROT-M12 FS-PA-CHAIN - 1430873

M12 sealing cap made of plastic with fixing band, for sensor cables, for free M12 plugs



Sensor/actuator cable - SAC-12P-MS/ 3,0-35T/FS SH SCO - 1402551

Accessories

Safety locking

Locking clip - SAC-M12-EXCLIP-M - 1558988



Locking clip for the pin side of sensor/actuator cables with M12 connector and M12 connectors for assembly, for knurl diameter: 15 mm or for Allen key with a wrench size of 14 mm, prevents the disconnection of plug-in connections without tools

Locking clip - SAC-M12-EXCLIP-F - 1558991



Locking clip for the socket side of sensor/actuator cables with M12 connector and M12 connectors for assembly, for knurl diameter: 15 mm or for Allen key with a wrench size of 14 mm, prevents the disconnection of plug-in connections without tools

Screwdriver tools

Adapter insert - TSD-M SAC-BIT ADAPTER - 1212600



Adapter bit for TSD-M...torque tools, E6.3-1/4" drive with 4 mm hexagon to accommodate SAC bits

Tool - SAC BIT M12-D15 - 1208432



Nut for assembling sensor/actuator cables with M12 connector and M12 connectors for assembly, with a knurl diameter of 15 mm, for 4 mm hexagonal drive

Torque tool

Torque screwdriver - TSD 04 SAC - 1208429



Torque screwdriver, with preset torque of 0.4 Nm and 4 mm hexagonal drive for M12 connectors

Sensor/actuator cable - SAC-12P-MS/ 3,0-35T/FS SH SCO - 1402551

Accessories

Torque screwdriver - TSD-M 1,2NM - 1212224



Torque screw driver, accuracy as per EN ISO 6789 standard, adjustable from 0.3 - 1.2 Nm

Phoenix Contact 2020 © - all rights reserved
<http://www.phoenixcontact.com>

PHOENIX CONTACT GmbH & Co. KG
Flachsmarktstr. 8
32825 Blomberg
Germany
Tel. +49 5235 300
Fax +49 5235 3 41200
<http://www.phoenixcontact.com>

Mouser Electronics

Authorized Distributor

Click to View Pricing, Inventory, Delivery & Lifecycle Information:

[Phoenix Contact:](#)

[1402551](#)