

Part Number:

Product Description:

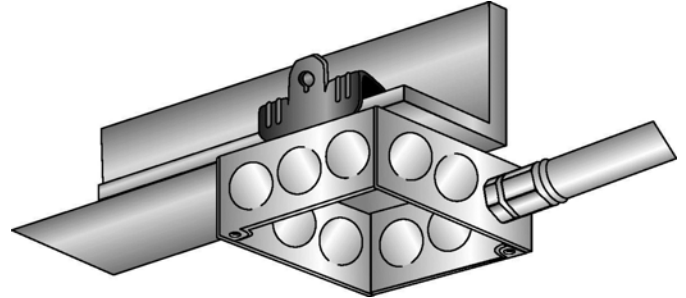
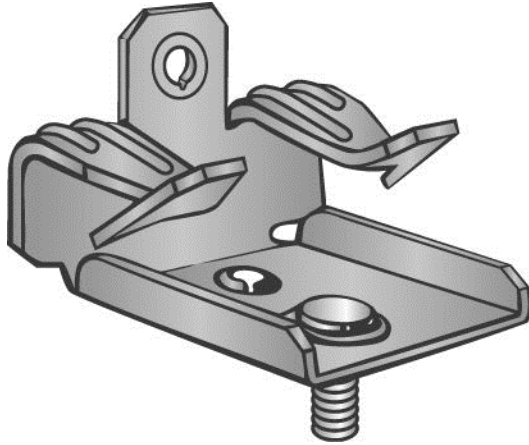

Material Specifications

Type:

Finish:

Color:

Function Specifications

Compatible Wires and Cables

AC/MC CABLE (OD):

Drop Wire:

Plain Rod (in):

Threaded Rods and Bolts

Tapped Holes:

Clearance Holes (in):

Threaded Rod Size (in):

Compatible Conduit

EMT Size (in):

Rigid/IMC (in):

Compatible Flanges and Studs

Flange Size (in):

Metal Stud Size (ins):

Static Load Rating

Vertical (lbs):

Horizontal (lbs):

Other

Codes and Regulatory

Regulatory Certifications:

Country of Origin:

Packaging

General Packaging:

Box Size:

Pieces per Package:

Other Box Features:

Document Information

Created By:

Checked By:

Approved By:

Customer Specification #:

Revision Level:

ECN #:

Date:

Mouser Electronics

Authorized Distributor

Click to View Pricing, Inventory, Delivery & Lifecycle Information:

[Panduit:](#)

[PM24S](#)