



HMHAA280

AC Input, Half Pitch Mini-Flat Package 4-Pin Optocoupler

Features

- Compact 4-pin package (2.4mm maximum standoff height)
- Half pitch leads for optimum board space savings
- Current Transfer Ratio: 50–600%
- Available in tape and reel quantities of 2500
- CSA (File #1201524), UL (File #E90700) and VDE (File #136480) certified

Description

The HMHAA280 series consists of two gallium arsenide infrared emitting diodes, connected in inverse parallel, driving a single silicon phototransistor in a compact 4-pin mini-flat package. The lead pitch is 1.27mm.

Applications

- AC line monitor
- Unknown polarity DC sensor
- Telephone line receiver

Package Dimensions

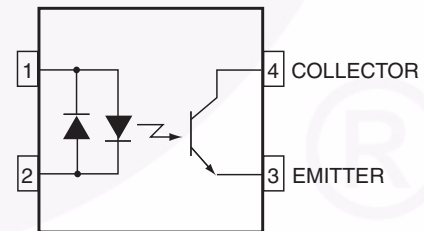
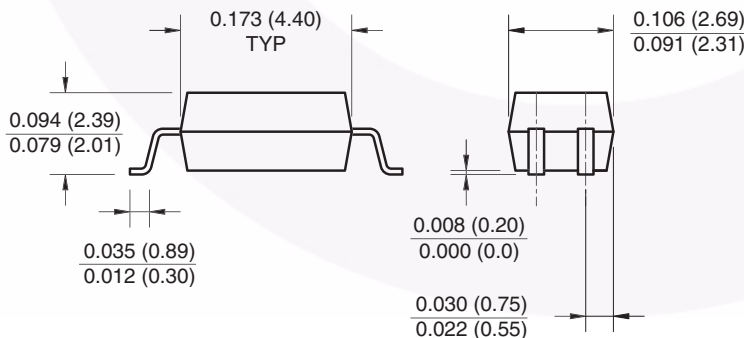
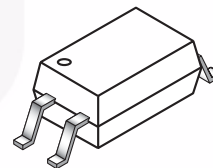
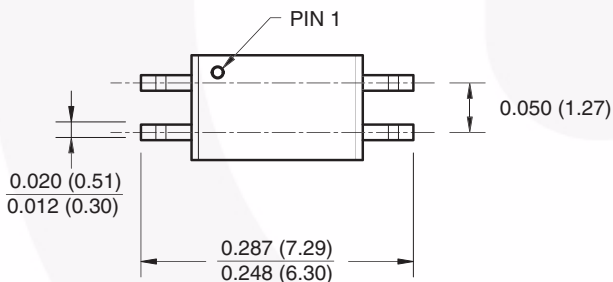

Equivalent Circuit

Note:

All dimensions are in inches (millimeters)

Absolute Maximum Ratings ($T_A = 25^\circ\text{C}$ unless otherwise specified)

Stresses exceeding the absolute maximum ratings may damage the device. The device may not function or be operable above the recommended operating conditions and stressing the parts to these levels is not recommended. In addition, extended exposure to stresses above the recommended operating conditions may affect device reliability. The absolute maximum ratings are stress ratings only.

Symbol	Parameter	Value	Units
TOTAL PACKAGE			
T_{STG}	Storage Temperature	-55 to +125	$^\circ\text{C}$
T_{OPR}	Operating Temperature	-55 to +100	$^\circ\text{C}$
EMITTER			
$I_{\text{F (avg)}}$	Continuous Forward Current	50	mA
$I_{\text{F (pk)}}$	Peak Forward Current (1 μs pulse, 300pps.)	1	A
V_{R}	Reverse Input Voltage	6	V
P_{D}	Power Dissipation	60	mW
	Derate linearly (above 25°C)	0.6	mW/ $^\circ\text{C}$
DETECTOR			
	Continuous Collector Current	50	mA
P_{D}	Power Dissipation	150	mW
	Derate linearly (above 25°C)	1.5	mW/ $^\circ\text{C}$
V_{CEO}	Collector-Emitter Voltage	80	V
V_{ECO}	Emitter-Collector Voltage	7	V

Electrical Characteristics ($T_A = 25^\circ\text{C}$)

Symbol	Parameter	Test Conditions	Min.	Typ.*	Max.	Unit
INDIVIDUAL COMPONENT CHARACTERISTICS						
Emitter						
V_F	Forward Voltage	$I_F = \pm 5\text{mA}$			1.4	V
I_R	Reverse Current	$V_R = 5\text{V}$			5	μA
Detector						
BV_{CEO}	Breakdown Voltage Collector to Emitter	$I_C = 0.5\text{mA}, I_F = 0$	80			V
BV_{ECO}	Emitter to Collector	$I_E = 100\mu\text{A}, I_F = 0$	7			
I_{CEO}	Collector Dark Current	$V_{CE} = 80\text{V}, I_F = 0$			100	nA
C_{CE}	Capacitance	$V_{CE} = 0\text{V}, f = 1\text{MHz}$		10		pF
TRANSFER CHARACTERISTICS						
CTR	DC Current Transfer Ratio	$I_F = \pm 5\text{mA}, V_{CE} = 5\text{V}$	50		600	%
	CTR Symmetry	$I_F = \pm 5\text{mA}, V_{CE} = 5\text{V}$	0.33		3.0	
$V_{CE(SAT)}$	Saturation Voltage	$I_F = \pm 8\text{mA}, I_C = 2.4\text{mA}$			0.4	V
t_r	Rise Time (Non-Saturated)	$I_C = 2\text{mA}, V_{CE} = 5\text{V}, R_L = 100\Omega$		3		μs
t_f	Fall Time (Non-Saturated)	$I_C = 2\text{mA}, V_{CE} = 5\text{V}, R_L = 100\Omega$		3		
ISOLATION CHARACTERISTICS						
V_{ISO}	Steady State Isolation Voltage	1 Minute	3750			VRMS

*All typicals at $T_A = 25^\circ\text{C}$

Typical Performance Characteristics

Fig. 1 Forward Current vs. Forward Voltage

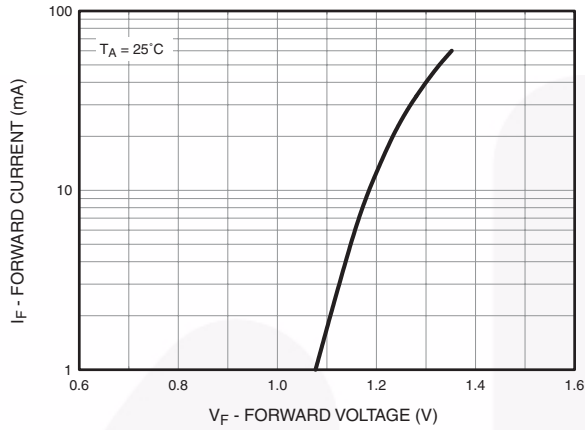

Fig. 2 Collector Current vs. Forward Current

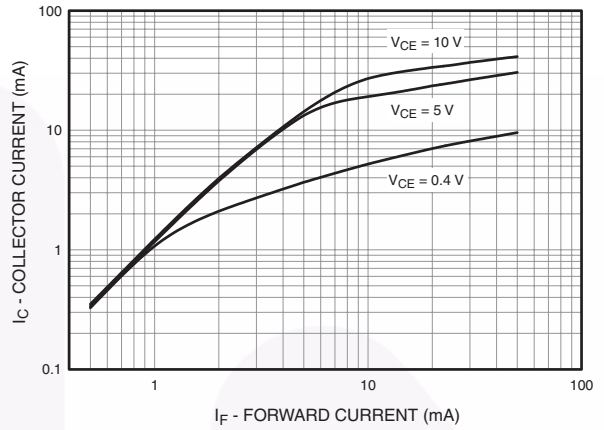

Fig. 3 Current Transfer Ratio vs. Forward Current

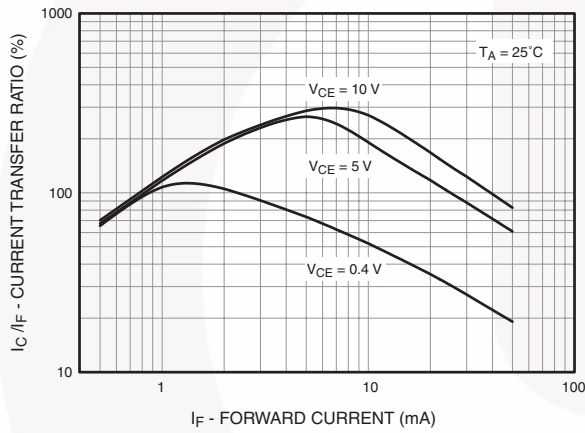

Fig. 4 Normalized CTR vs. Temperature

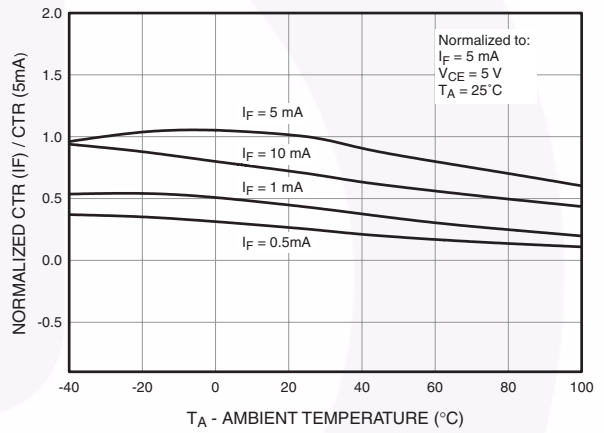
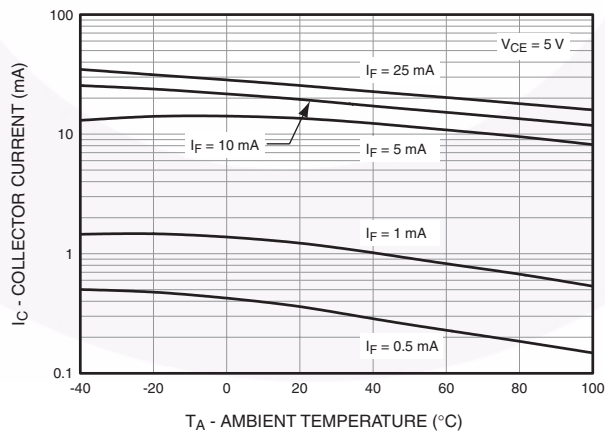

Fig. 5 Collector Current vs. Temperature



Typical Performance Characteristics (Continued)

Fig. 6 Collector Current vs. Collector-Emitter Voltage

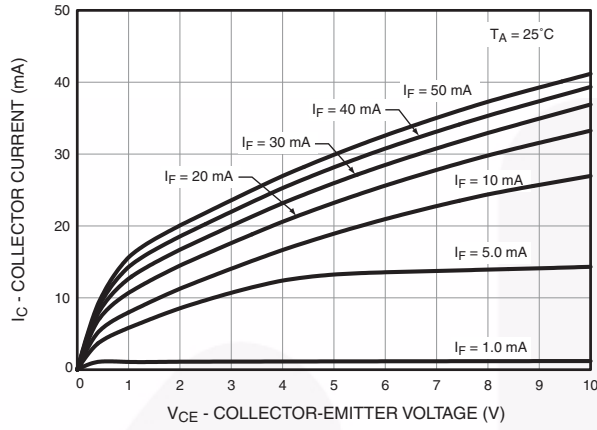

Fig. 7 Collector Current vs. Collector-Emitter Voltage

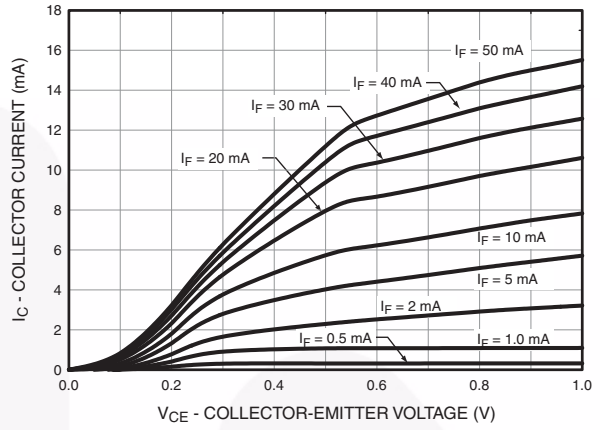

Fig. 8 Collector Dark Current vs. Temperature

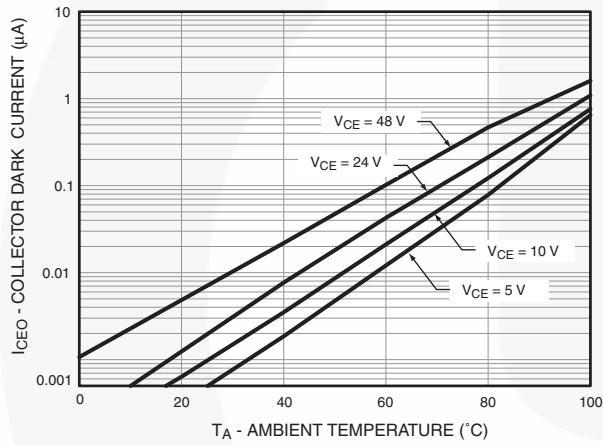

Fig. 9 Switching Time vs. Load Resistance

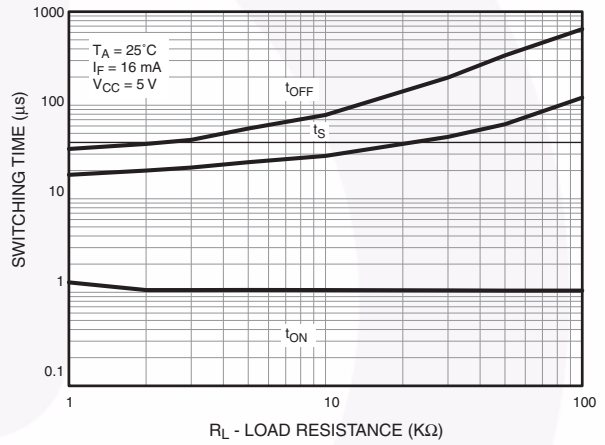
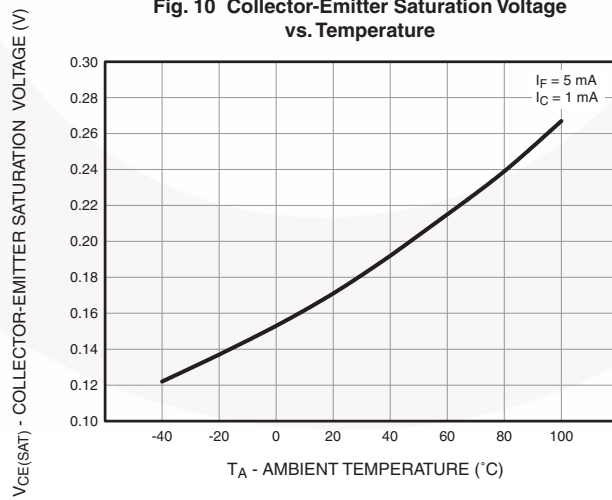

Fig. 10 Collector-Emitter Saturation Voltage vs. Temperature



Ordering Information

Option	Description
V	VDE Approved
R2	Tape and Reel (2500 units)
R2V	Tape and Reel (2500 units) and VDE Approved

Marking Information

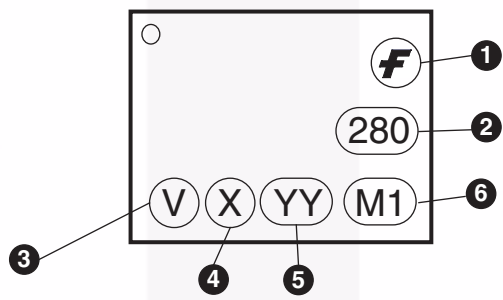

Definitions	
1	Fairchild logo
2	Device number
3	VDE mark (Note: Only appears on parts ordered with VDE option – See order entry table)
4	One digit year code
5	Two digit work week ranging from '01' to '53'
6	Assembly package code

Tape and Reel Dimensions

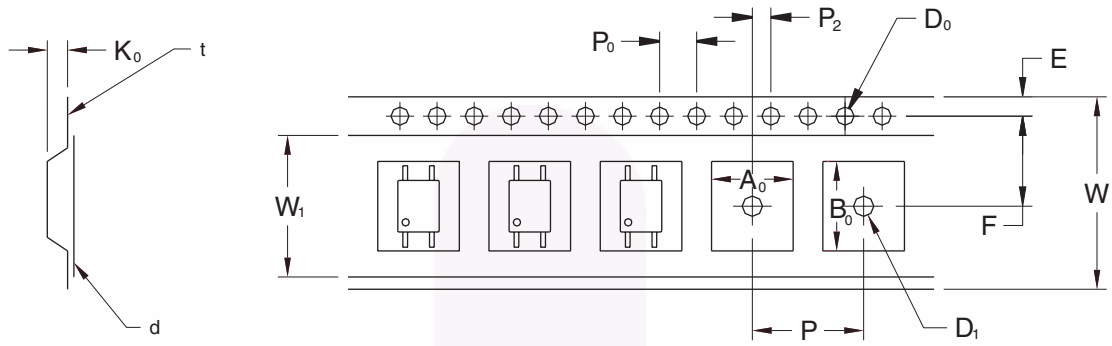

		1.27 Pitch
Description	Symbol	Dimensions (mm)
Tape Width	W	12.00 +0.30/-0.10
Tape Thickness	t	0.30 ±0.05
Sprocket Hole Pitch	P ₀	4.00 ±0.10
Sprocket Hole Diameter	D ₀	1.50 +0.10/-0.0
Sprocket Hole Location	E	1.75 ±0.10
Pocket Location	F	5.50 ±0.10
	P ₂	2.00 ±0.10
Pocket Pitch	P	8.00 ±0.10
Pocket Dimension	A ₀	2.80 ±0.10
	B ₀	7.30 ±0.10
	K ₀	2.30 ±0.10
Pocket Hole Diameter	D ₁	1.50 Min.
Cover Tape Width	W ₁	9.20
Cover Tape Thickness	d	0.065 ±0.010
Max. Component Rotation or Tilt		10° Max.
Devices Per Reel		2500
Reel Diameter		330mm (13")

Footprint Drawing for PCB Layout

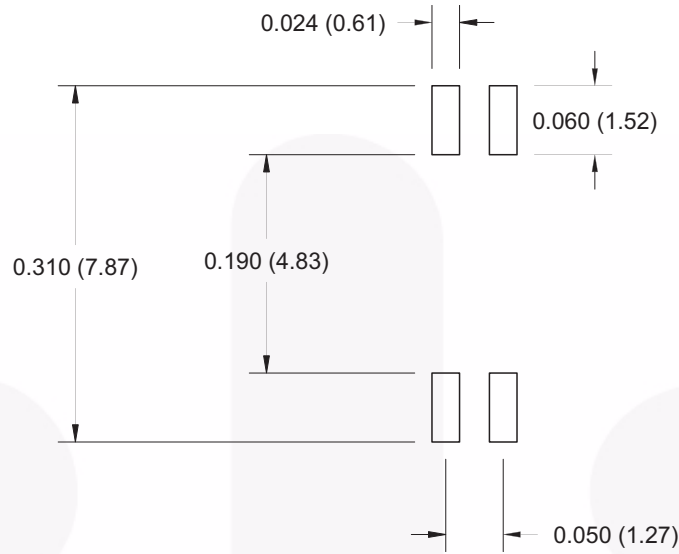

Reflow Profile0

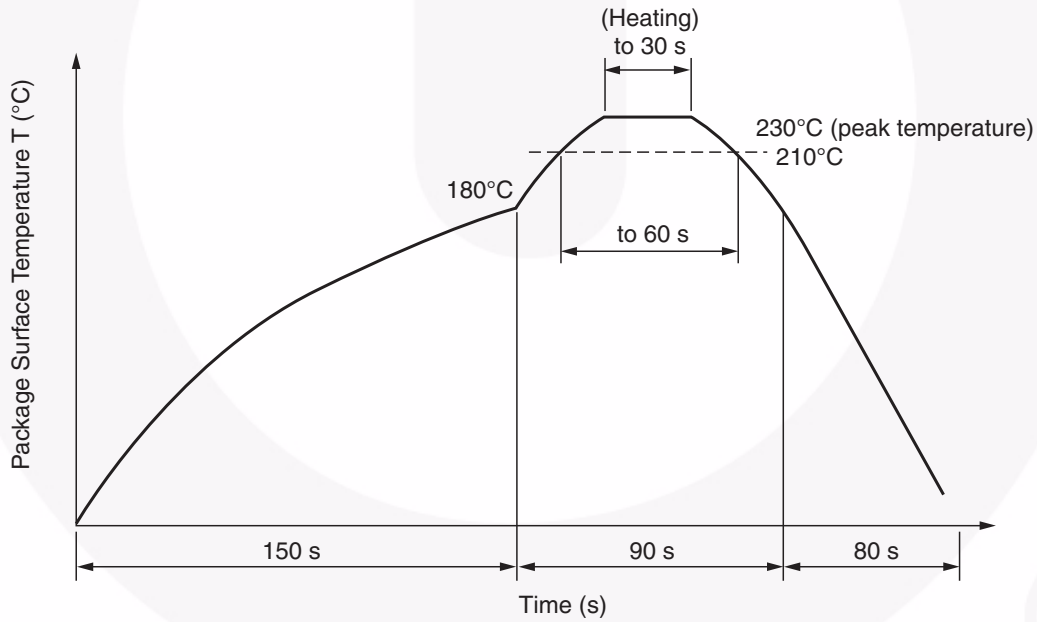





- Peak reflow temperature: 230°C (package surface temperature) for 30 seconds
- Time of temperature higher than 210°C: 60 seconds or less
- One time soldering reflow is recommended



TRADEMARKS

The following includes registered and unregistered trademarks and service marks, owned by Fairchild Semiconductor and/or its global subsidiaries, and is not intended to be an exhaustive list of all such trademarks.

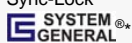
AccuPower™	FPS™	Power-SPM™	The Power Franchise®
Auto-SPM™	F-PFS™	PowerTrench®	The Right Technology for Your Success™
AX-CAP™*	FRFET®	PowerXS™	the
BitSiC®	Global Power Resource SM	Programmable Active Droop™	power
Build it Now™	Green FPS™	QFET®	franchise
CorePLUS™	Green FPS™ e-Series™	QS™	TinyBoost™
CorePOWER™	Gmax™	Quiet Series™	TinyBuck™
CROSSVOL™	GTO™	RapidConfigure™	TinyCalc™
CTL™	IntelliMAX™	 ™	TinyLogic®
Current Transfer Logic™	ISOPLANAR™	Saving our world, 1mW/W/kW at a time™	TINYOPTO™
DEUXPEED®	MegaBuck™	SignalWise™	TinyPower™
Dual Cool™	MICROCOUPLER™	SmartMax™	TinyPWM™
EcoSPARK®	MicroFET™	SMART START™	TinyWire™
EfficientMax™	MicroPak™	SPM®	TranSiC®
ESBC™	MicroPak2™	STEALTH™	TriFault Detect™
 Fairchild®	MillerDrive™	SuperFET®	TRUECURRENT®*
Fairchild Semiconductor®	MotionMax™	SuperSOT™-3	µSerDes™
FACT Quiet Series™	Motion-SPM™	SuperSOT™-6	 SerDes®
FACT®	mWSaver™	SuperSOT™-8	UHC®
FAST®	OptoHiT™	SupreMOS®	Ultra FRFET™
FastvCore™	OPTOLOGIC®	SyncFET™	UniFET™
FETBench™	OPTOPLANAR®	Sync-Lock™	VCX™
FlashWriter®*	 PDP SPM™	 SYSTEM GENERAL®*	VisualMax™
			XS™

* Trademarks of System General Corporation, used under license by Fairchild Semiconductor.

DISCLAIMER

FAIRCHILD SEMICONDUCTOR RESERVES THE RIGHT TO MAKE CHANGES WITHOUT FURTHER NOTICE TO ANY PRODUCTS HEREIN TO IMPROVE RELIABILITY, FUNCTION, OR DESIGN. FAIRCHILD DOES NOT ASSUME ANY LIABILITY ARISING OUT OF THE APPLICATION OR USE OF ANY PRODUCT OR CIRCUIT DESCRIBED HEREIN; NEITHER DOES IT CONVEY ANY LICENSE UNDER ITS PATENT RIGHTS, NOR THE RIGHTS OF OTHERS. THESE SPECIFICATIONS DO NOT EXPAND THE TERMS OF FAIRCHILD'S WORLDWIDE TERMS AND CONDITIONS, SPECIFICALLY THE WARRANTY THEREIN, WHICH COVERS THESE PRODUCTS.

LIFE SUPPORT POLICY

FAIRCHILD'S PRODUCTS ARE NOT AUTHORIZED FOR USE AS CRITICAL COMPONENTS IN LIFE SUPPORT DEVICES OR SYSTEMS WITHOUT THE EXPRESS WRITTEN APPROVAL OF FAIRCHILD SEMICONDUCTOR CORPORATION.

As used herein:

1. Life support devices or systems are devices or systems which, (a) are intended for surgical implant into the body or (b) support or sustain life, and (c) whose failure to perform when properly used in accordance with instructions for use provided in the labeling, can be reasonably expected to result in a significant injury of the user.
2. A critical component in any component of a life support, device, or system whose failure to perform can be reasonably expected to cause the failure of the life support device or system, or to affect its safety or effectiveness.

ANTI-COUNTERFEITING POLICY

Fairchild Semiconductor Corporation's Anti-Counterfeiting Policy. Fairchild's Anti-Counterfeiting Policy is also stated on our external website, www.fairchildsemi.com, under Sales Support.

Counterfeiting of semiconductor parts is a growing problem in the industry. All manufacturers of semiconductor products are experiencing counterfeiting of their parts. Customers who inadvertently purchase counterfeit parts experience many problems such as loss of brand reputation, substandard performance, failed applications, and increased cost of production and manufacturing delays. Fairchild is taking strong measures to protect ourselves and our customers from the proliferation of counterfeit parts. Fairchild strongly encourages customers to purchase Fairchild parts either directly from Fairchild or from Authorized Fairchild Distributors who are listed by country on our web page cited above. Products customers buy either from Fairchild directly or from Authorized Fairchild Distributors are genuine parts, have full traceability, meet Fairchild's quality standards for handling and storage and provide access to Fairchild's full range of up-to-date technical and product information. Fairchild and our Authorized Distributors will stand behind all warranties and will appropriately address any warranty issues that may arise. Fairchild will not provide any warranty coverage or other assistance for parts bought from Unauthorized Sources. Fairchild is committed to combat this global problem and encourage our customers to do their part in stopping this practice by buying direct or from authorized distributors.

PRODUCT STATUS DEFINITIONS

Definition of Terms

Datasheet Identification	Product Status	Definition
Advance Information	Formative / In Design	Datasheet contains the design specifications for product development. Specifications may change in any manner without notice.
Preliminary	First Production	Datasheet contains preliminary data; supplementary data will be published at a later date. Fairchild Semiconductor reserves the right to make changes at any time without notice to improve design.
No Identification Needed	Full Production	Datasheet contains final specifications. Fairchild Semiconductor reserves the right to make changes at any time without notice to improve the design.
Obsolete	Not In Production	Datasheet contains specifications on a product that is discontinued by Fairchild Semiconductor. The datasheet is for reference information only.

Mouser Electronics

Authorized Distributor

Click to View Pricing, Inventory, Delivery & Lifecycle Information:

[onsemi:](#)

[HMHAA280R1V](#) [HMHAA280R1](#) [HMHAA280R4V](#) [HMHAA280R3V](#) [HMHAA280_Q](#) [HMHAA280R4](#)