

# NSS1C200L, NSV1C200L

## 100 V, 2.0 A, Low $V_{CE(sat)}$ PNP Transistor

ON Semiconductor's e<sup>2</sup>PowerEdge family of low  $V_{CE(sat)}$  transistors are miniature surface mount devices featuring ultra low saturation voltage ( $V_{CE(sat)}$ ) and high current gain capability. These are designed for use in low voltage, high speed switching applications where affordable efficient energy control is important.

Typical applications are DC-DC converters and power management in portable and battery powered products such as cellular and cordless phones, PDAs, computers, printers, digital cameras and MP3 players. Other applications are low voltage motor controls in mass storage products such as disc drives and tape drives. In the automotive industry they can be used in air bag deployment and in the instrument cluster. The high current gain allows e<sup>2</sup>PowerEdge devices to be driven directly from PMU's control outputs, and the Linear Gain (Beta) makes them ideal components in analog amplifiers.

### Features

- NSV Prefix for Automotive and Other Applications Requiring Unique Site and Control Change Requirements; AEC-Q101 Qualified and PPAP Capable
- These Devices are Pb-Free, Halogen Free/BFR Free and are RoHS Compliant

### MAXIMUM RATINGS ( $T_A = 25^\circ\text{C}$ )

| Rating                         | Symbol    | Max  | Unit |
|--------------------------------|-----------|------|------|
| Collector-Emitter Voltage      | $V_{CEO}$ | -100 | Vdc  |
| Collector-Base Voltage         | $V_{CBO}$ | -140 | Vdc  |
| Emitter-Base Voltage           | $V_{EBO}$ | -7.0 | Vdc  |
| Collector Current - Continuous | $I_C$     | -2.0 | A    |
| Collector Current - Peak       | $I_{CM}$  | -3.0 | A    |

### THERMAL CHARACTERISTICS

| Characteristic  | Symbol                   | Max            | Unit                      |
|---|--------------------------|----------------|---------------------------|
| Total Device Dissipation<br>$T_A = 25^\circ\text{C}$<br>Derate above $25^\circ\text{C}$ | $P_D$ (Note 1)           | 490            | mW                        |
| Thermal Resistance,<br>Junction-to-Ambient  | $R_{\theta JA}$ (Note 1) | 255            | $^\circ\text{C}/\text{W}$ |
| Total Device Dissipation<br>$T_A = 25^\circ\text{C}$<br>Derate above $25^\circ\text{C}$ | $P_D$ (Note 2)           | 710            | mW                        |
| Thermal Resistance,<br>Junction-to-Ambient  | $R_{\theta JA}$ (Note 2) | 176            | $^\circ\text{C}/\text{W}$ |
| Junction and Storage<br>Temperature Range   | $T_J, T_{stg}$           | -55 to<br>+150 | $^\circ\text{C}$          |

Stresses exceeding those listed in the Maximum Ratings table may damage the device. If any of these limits are exceeded, device functionality should not be assumed, damage may occur and reliability may be affected.

1. FR-4 @ 100 mm<sup>2</sup>, 1 oz. copper traces.
2. FR-4 @ 500 mm<sup>2</sup>, 1 oz. copper traces.



ON Semiconductor®

[www.onsemi.com](http://www.onsemi.com)

## -100 VOLTS, 2.0 AMPS PNP LOW $V_{CE(sat)}$ TRANSISTOR

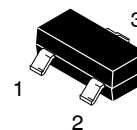
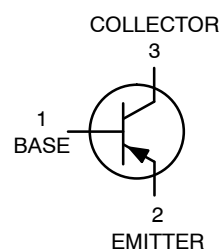

SOT-23 (TO-236)  
CASE 318  
STYLE 6

### MARKING DIAGRAM

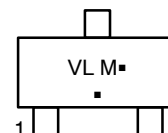

VL = Specific Device Code  
M = Date Code\*  
■ = Pb-Free Package

(Note: Microdot may be in either location)

\*Date Code orientation and/or overbar may vary depending upon manufacturing location.

### ORDERING INFORMATION

| Device                        | Package             | Shipping†        |
|-------------------------------|---------------------|------------------|
| NSS1C200LT1G,<br>NSV1C200LT1G | SOT-23<br>(Pb-Free) | 3000/Tape & Reel |

†For information on tape and reel specifications, including part orientation and tape sizes, please refer to our Tape and Reel Packaging Specification Brochure, BRD8011/D.

# NSS1C200L, NSV1C200L

## ELECTRICAL CHARACTERISTICS ( $T_A = 25^\circ\text{C}$ unless otherwise noted)

| Characteristic   | Symbol        | Min  | Typ | Max  | Unit |
|--|---------------|------|-----|------|------|
| <b>OFF CHARACTERISTICS</b>   |               |      |     |      |      |
| Collector – Emitter Breakdown Voltage<br>( $I_C = -10\text{ mA}$ , $I_B = 0$ ) | $V_{(BR)CEO}$ | -100 |     |      | Vdc  |
| Collector – Base Breakdown Voltage<br>( $I_C = -0.1\text{ mA}$ , $I_E = 0$ )   | $V_{(BR)CBO}$ | -140 |     |      | Vdc  |
| Emitter – Base Breakdown Voltage<br>( $I_E = -0.1\text{ mA}$ , $I_C = 0$ )     | $V_{(BR)EBO}$ | -7.0 |     |      | Vdc  |
| Collector Cutoff Current<br>( $V_{CB} = -140\text{ Vdc}$ , $I_E = 0$ )         | $I_{CBO}$     |      |     | -100 | nAdc |
| Emitter Cutoff Current<br>( $V_{EB} = -6.0\text{ Vdc}$ )                       | $I_{EBO}$     |      |     | -50  | nAdc |

## ON CHARACTERISTICS

|   |               |                        |     |                                      |     |
|---|---------------|------------------------|-----|--------------------------------------|-----|
| DC Current Gain (Note 3)<br>( $I_C = -10\text{ mA}$ , $V_{CE} = -2.0\text{ V}$ )<br>( $I_C = -500\text{ mA}$ , $V_{CE} = -2.0\text{ V}$ )<br>( $I_C = -1.0\text{ A}$ , $V_{CE} = -2.0\text{ V}$ )<br>( $I_C = -2.0\text{ A}$ , $V_{CE} = -2.0\text{ V}$ )                 | $h_{FE}$      | 150<br>120<br>80<br>50 | 240 | 360                                  |     |
| Collector – Emitter Saturation Voltage (Note 3)<br>( $I_C = -0.1\text{ A}$ , $I_B = -0.01\text{ A}$ )<br>( $I_C = -0.5\text{ A}$ , $I_B = -0.05\text{ A}$ )<br>( $I_C = -1.0\text{ A}$ , $I_B = -0.100\text{ A}$ )<br>( $I_C = -2.0\text{ A}$ , $I_B = -0.200\text{ A}$ ) | $V_{CE(sat)}$ |                        |     | -0.040<br>-0.080<br>-0.115<br>-0.250 | V   |
| Base – Emitter Saturation Voltage (Note 3)<br>( $I_C = -1.0\text{ A}$ , $I_B = -0.100\text{ A}$ )   | $V_{BE(sat)}$ |                        |     | -0.950                               | V   |
| Base – Emitter Turn-on Voltage (Note 3)<br>( $I_C = -1.0\text{ A}$ , $V_{CE} = -2.0\text{ V}$ )   | $V_{BE(on)}$  |                        |     | -0.850                               | V   |
| Cutoff Frequency<br>( $I_C = -100\text{ mA}$ , $V_{CE} = -5.0\text{ V}$ , $f = 100\text{ MHz}$ )  | $f_T$         |                        | 120 |                                      | MHz |
| Input Capacitance ( $V_{EB} = 2.0\text{ V}$ , $f = 1.0\text{ MHz}$ )  | $C_{ibo}$     |                        | 200 |                                      | pF  |
| Output Capacitance ( $V_{CB} = 10\text{ V}$ , $f = 1.0\text{ MHz}$ )  | $C_{obo}$     |                        | 22  |                                      | pF  |

Product parametric performance is indicated in the Electrical Characteristics for the listed test conditions, unless otherwise noted. Product performance may not be indicated by the Electrical Characteristics if operated under different conditions.

3. Pulsed Condition: Pulse Width = 300 msec, Duty Cycle  $\leq 2\%$ .

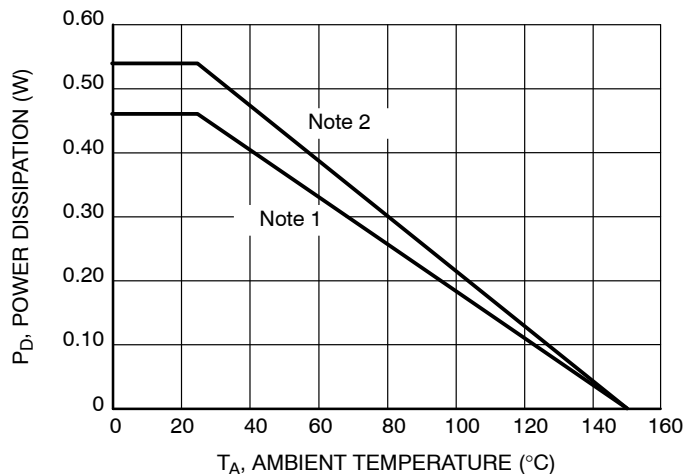

**Figure 1. Power Derating**

# NSS1C200L, NSV1C200L

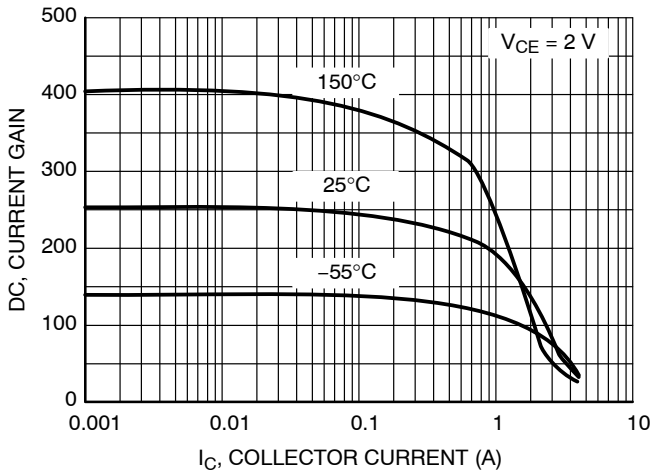

Figure 2. DC Current Gain

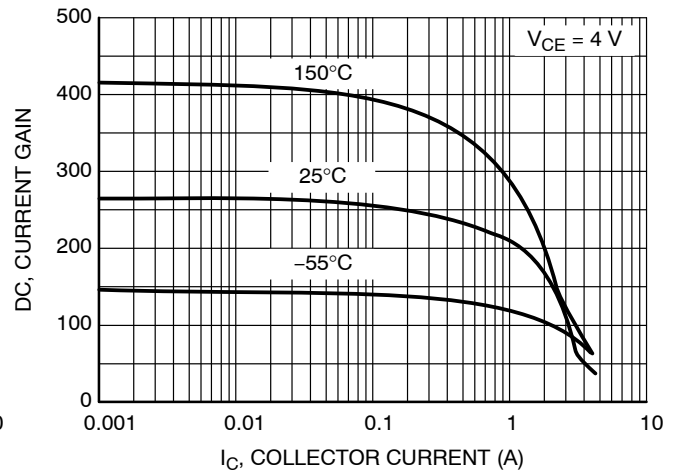

Figure 3. DC Current Gain

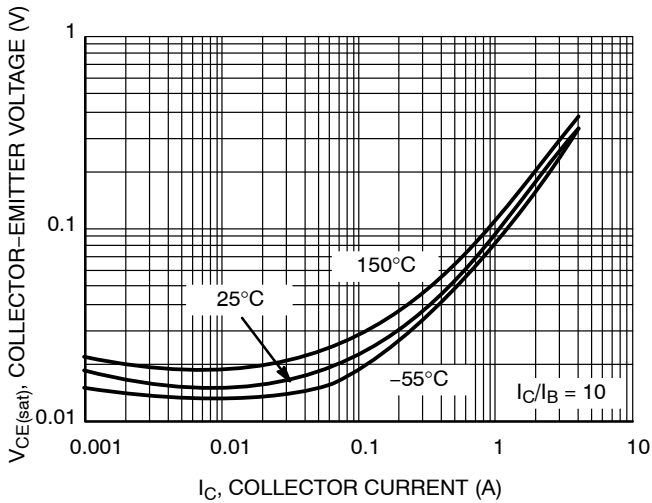

Figure 4. Collector-Emitter Saturation Voltage

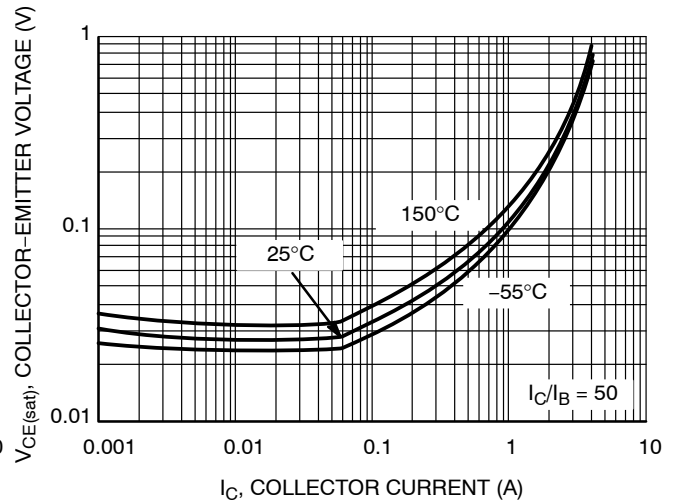

Figure 5. Collector-Emitter Saturation Voltage

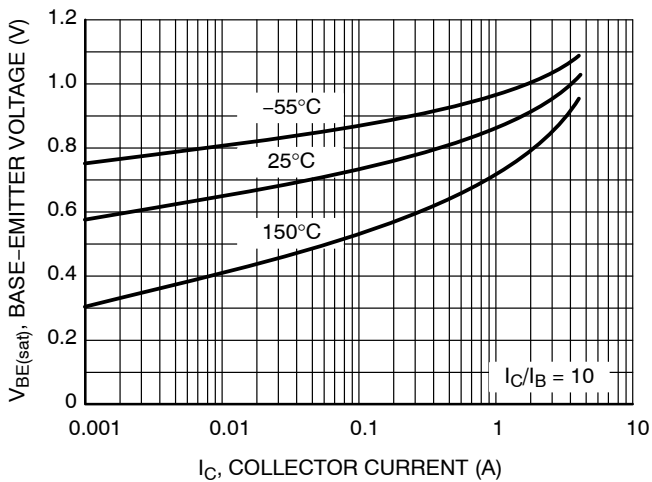

Figure 6. Base-Emitter Saturation Voltage

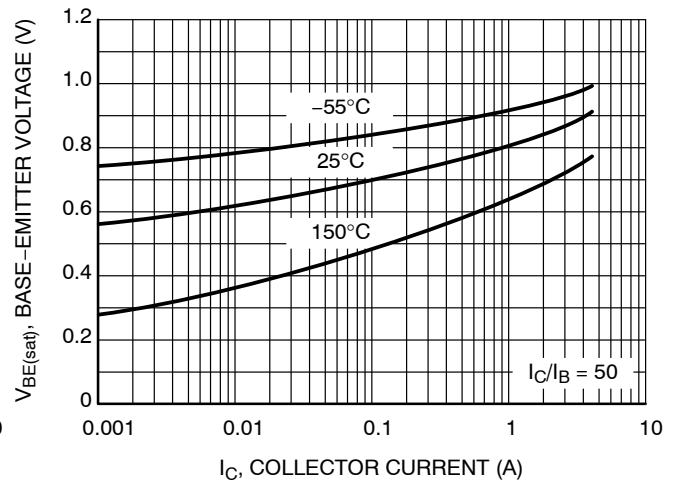
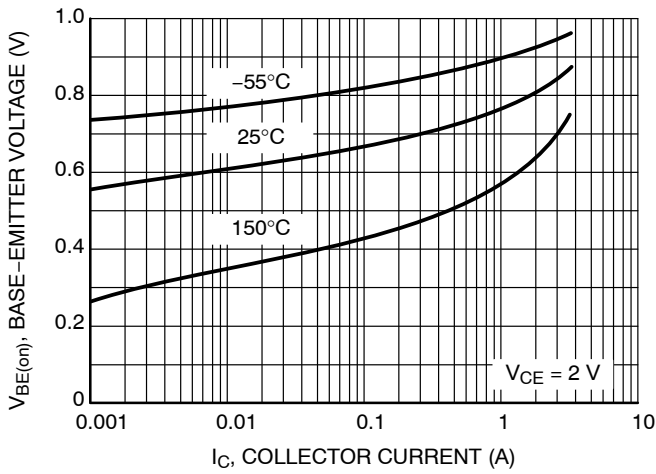
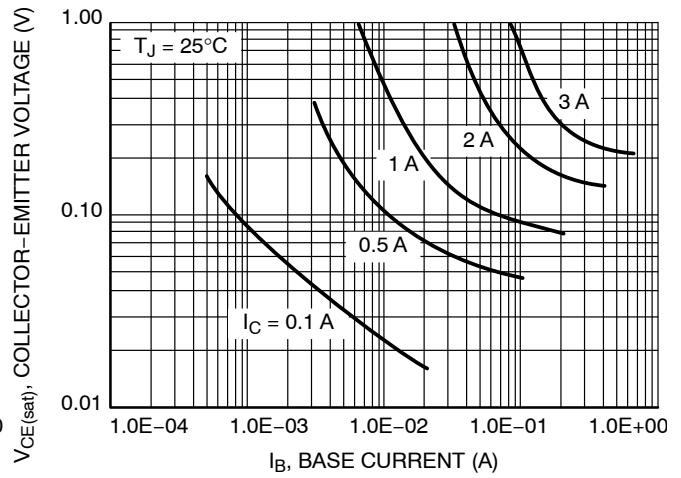

Figure 7. Base-Emitter Saturation Voltage

# NSS1C200L, NSV1C200L



**Figure 8. Base-Emitter Saturation Voltage**



**Figure 9. Collector Saturation Region**

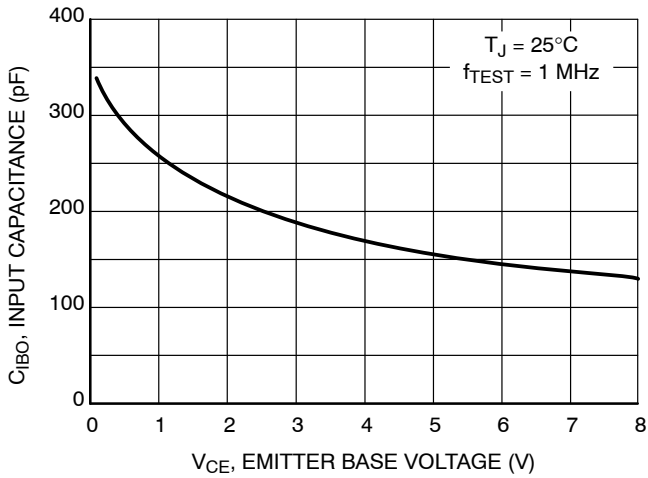

**Figure 10. Input Capacitance**

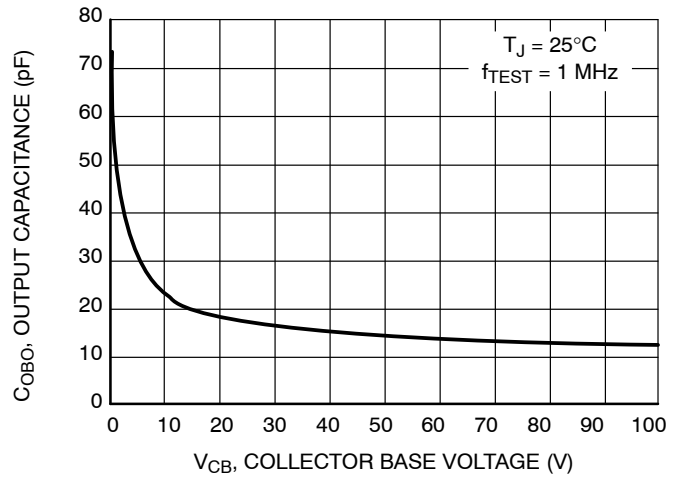

**Figure 11. Output Capacitance**

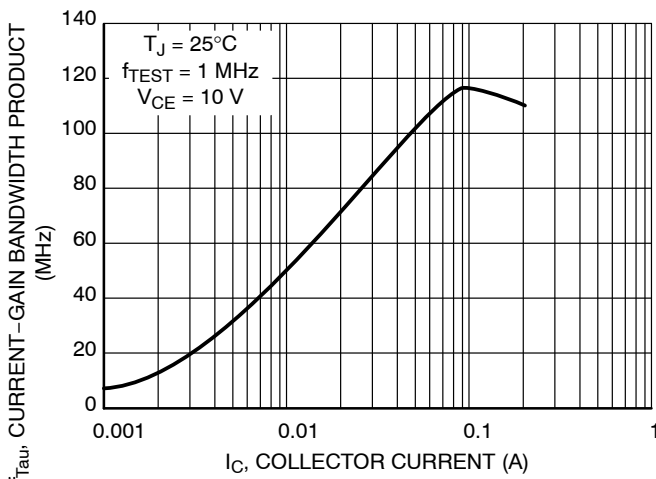

**Figure 12. Current-Gain Bandwidth Product**

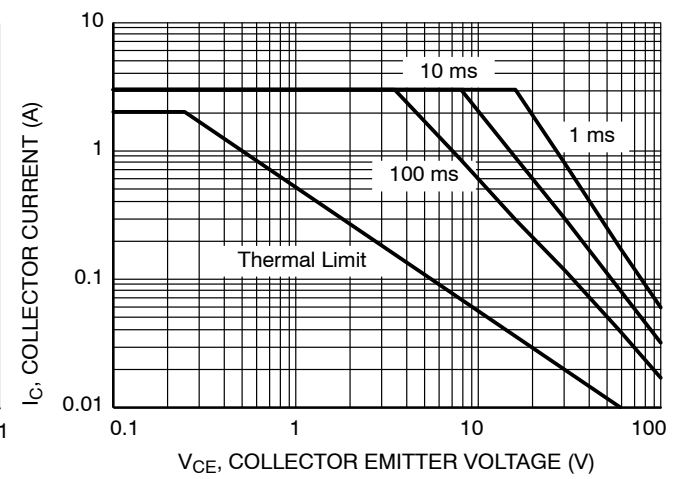

**Figure 13.**

# NSS1C200L, NSV1C200L

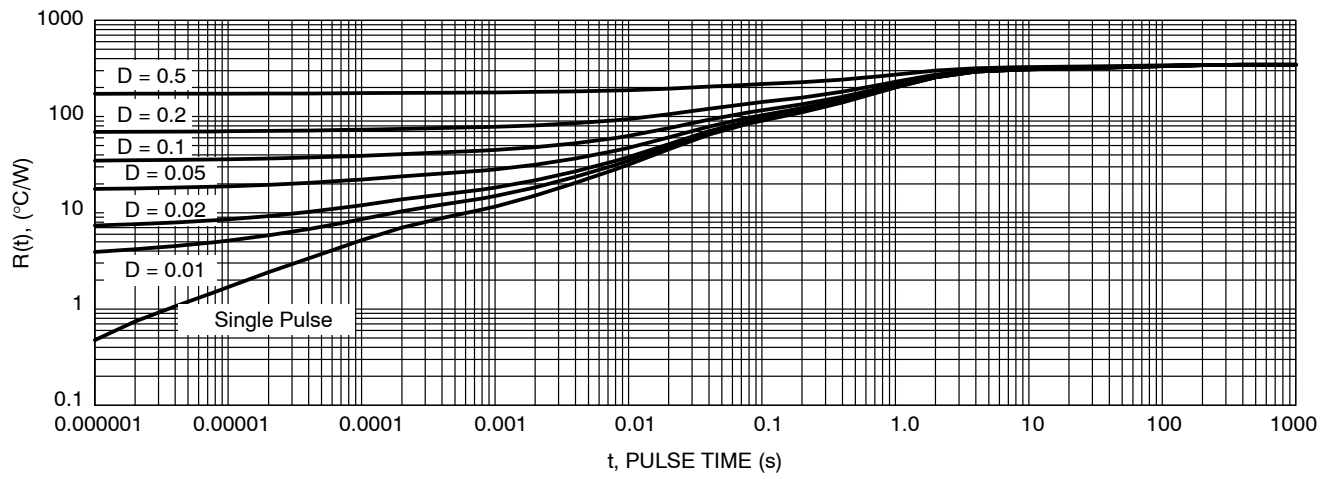
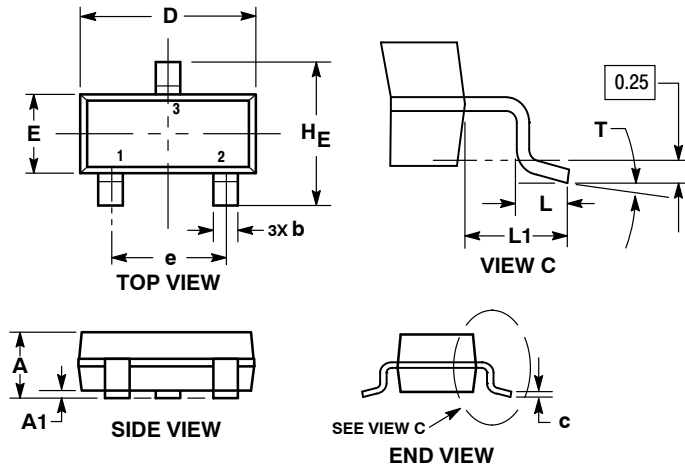

Figure 14. Transient Thermal Resistance

# NSS1C200L, NSV1C200L

## PACKAGE DIMENSIONS

SOT-23 (TO-236)  
CASE 318-08  
ISSUE AR



**NOTES:**

1. DIMENSIONING AND TOLERANCING PER ASME Y14.5M, 1994.
2. CONTROLLING DIMENSION: MILLIMETERS.
3. MAXIMUM LEAD THICKNESS INCLUDES LEAD FINISH. MINIMUM LEAD THICKNESS IS THE MINIMUM THICKNESS OF THE BASE MATERIAL.
4. DIMENSIONS D AND E DO NOT INCLUDE MOLD FLASH, PROTRUSIONS, OR GATE BURRS.

| DIM | MILLIMETERS |      |      | INCHES |       |       |
|-----|-------------|------|------|--------|-------|-------|
|     | MIN         | NOM  | MAX  | MIN    | NOM   | MAX   |
| A   | 0.89        | 1.00 | 1.11 | 0.035  | 0.039 | 0.044 |
| A1  | 0.01        | 0.06 | 0.10 | 0.000  | 0.002 | 0.004 |
| b   | 0.37        | 0.44 | 0.50 | 0.015  | 0.017 | 0.020 |
| c   | 0.08        | 0.14 | 0.20 | 0.003  | 0.006 | 0.008 |
| D   | 2.80        | 2.90 | 3.04 | 0.110  | 0.114 | 0.120 |
| E   | 1.20        | 1.30 | 1.40 | 0.047  | 0.051 | 0.055 |
| e   | 1.78        | 1.90 | 2.04 | 0.070  | 0.075 | 0.080 |
| L   | 0.30        | 0.43 | 0.55 | 0.012  | 0.017 | 0.022 |
| L1  | 0.35        | 0.54 | 0.69 | 0.014  | 0.021 | 0.027 |
| HE  | 2.10        | 2.40 | 2.64 | 0.083  | 0.094 | 0.104 |
| T   | 0°          | ---  | 10°  | 0°     | ---   | 10°   |

**STYLE 6:**

1. BASE
2. EMITTER
3. COLLECTOR

### RECOMMENDED SOLDERING FOOTPRINT\*

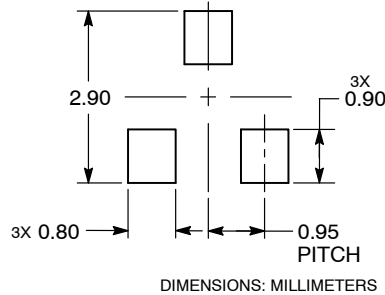

\*For additional information on our Pb-Free strategy and soldering details, please download the ON Semiconductor Soldering and Mounting Techniques Reference Manual, SOLDERRM/D.

ON Semiconductor and are trademarks of Semiconductor Components Industries, LLC dba ON Semiconductor or its subsidiaries in the United States and/or other countries. ON Semiconductor owns the rights to a number of patents, trademarks, copyrights, trade secrets, and other intellectual property. A listing of ON Semiconductor's product/patent coverage may be accessed at [www.onsemi.com/site/pdf/Patent-Marking.pdf](http://www.onsemi.com/site/pdf/Patent-Marking.pdf). ON Semiconductor reserves the right to make changes without further notice to any products herein. ON Semiconductor makes no warranty, representation or guarantee regarding the suitability of its products for any particular purpose, nor does ON Semiconductor assume any liability arising out of the application or use of any product or circuit, and specifically disclaims any and all liability, including without limitation special, consequential or incidental damages. Buyer is responsible for its products and applications using ON Semiconductor products, including compliance with all laws, regulations and safety requirements or standards, regardless of any support or applications information provided by ON Semiconductor. "Typical" parameters which may be provided in ON Semiconductor data sheets and/or specifications can and do vary in different applications and actual performance may vary over time. All operating parameters, including "Typicals" must be validated for each customer application by customer's technical experts. ON Semiconductor does not convey any license under its patent rights nor the rights of others. ON Semiconductor products are not designed, intended, or authorized for use as a critical component in life support systems or any FDA Class 3 medical devices or medical devices with a same or similar classification in a foreign jurisdiction or any devices intended for implantation in the human body. Should Buyer purchase or use ON Semiconductor products for any such unintended or unauthorized application, Buyer shall indemnify and hold ON Semiconductor and its officers, employees, subsidiaries, affiliates, and distributors harmless against all claims, costs, damages, and expenses, and reasonable attorney fees arising out of, directly or indirectly, any claim of personal injury or death associated with such unintended or unauthorized use, even if such claim alleges that ON Semiconductor was negligent regarding the design or manufacture of the part. ON Semiconductor is an Equal Opportunity/Affirmative Action Employer. This literature is subject to all applicable copyright laws and is not for resale in any manner.

### PUBLICATION ORDERING INFORMATION

**LITERATURE FULFILLMENT:**  
Literature Distribution Center for ON Semiconductor  
19521 E. 32nd Pkwy, Aurora, Colorado 80011 USA  
**Phone:** 303-675-2175 or 800-344-3860 Toll Free USA/Canada  
**Fax:** 303-675-2176 or 800-344-3867 Toll Free USA/Canada  
**Email:** [orderlit@onsemi.com](mailto:orderlit@onsemi.com)

**N. American Technical Support:** 800-282-9855 Toll Free  
USA/Canada  
**Europe, Middle East and Africa Technical Support:**  
Phone: 421 33 790 2910  
**Japan Customer Focus Center**  
Phone: 81-3-5817-1050

**ON Semiconductor Website:** [www.onsemi.com](http://www.onsemi.com)  
**Order Literature:** <http://www.onsemi.com/orderlit>

For additional information, please contact your local Sales Representative

# Mouser Electronics

Authorized Distributor

Click to View Pricing, Inventory, Delivery & Lifecycle Information:

[ON Semiconductor:](#)

[NSS1C200LT1G](#) [NSV1C200LT1G](#)