

# CAT3649

## 6-Channel LED Driver with 32 Dimming Levels & PWM

### Description

The CAT3649 is a high efficiency fractional charge pump that can drive up to six LEDs. The inclusion of a 1.33x fractional charge pump mode increases the device efficiency by up to 10% over traditional 1.5x charge pumps with no added external capacitors.

Low noise input ripple is achieved by operating at a constant switching frequency which allows the use of small external ceramic capacitors. The multi-fractional charge pump supports a wide range of input voltages from 2.4 V to 5.5 V.

The LED current can be adjusted in different ways. The full-scale LED current is set to 25 mA once the device is enabled. Analog dimming in 32 linear steps is achieved via a 1-wire pulse-dimming input (ADIM). Further adjustment of the LED current can be done by applying a pulse width modulation (PWM) signal on the PWM input. The PWM dimming control is compatible with content adaptive brightness control (CABC) for a wide range of PWM signal frequency up to 200 kHz.

The CAT3649 can be shut down by holding the ADIM or PWM input in a logic low condition for greater than 30 ms.

ON Semiconductor's 1.33x charge pump switching architecture is patented.

### Features

- High Efficiency 1.33x Charge Pump
- Charge Pump: 1x, 1.33x, 1.5x, 2x
- Drives up to 6 LEDs at 25 mA Each
- PWM Dimming 100 Hz to 200 kHz for CABC
- 1-wire EZDim 32 Linear Steps (ADIM)
- Power Efficiency up to 92%
- Low Noise Input Ripple in All Modes
- "Zero" Current Shutdown Mode
- Soft Start and Current Limiting
- Short Circuit Protection
- Thermal Shutdown Protection
- 3 mm x 3 mm, 16-pad TQFN Package
- This Device is Pb-Free, Halogen Free/BFR Free and is RoHS Compliant

### Typical Applications (Note 1)

- LCD Display Backlight
- Cellular Phones
- Digital Still Cameras
- Handheld Devices

1. Typical application circuit with external components is shown in Figure 1.



ON Semiconductor®

<http://onsemi.com>



TQFN-16  
HV3 SUFFIX  
CASE 510AD

### PIN CONNECTIONS

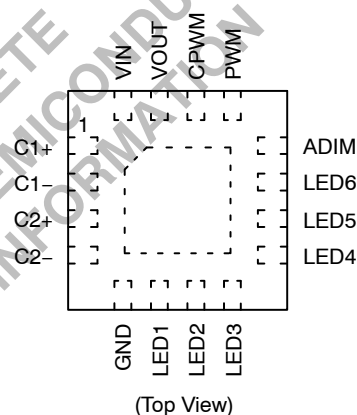

### MARKING DIAGRAM

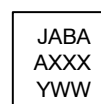

JABA = CAT3649HV3-GT2

A = Assembly Location

XXX = Last Three Digits of Assembly Lot Number

Y = Production Year (Last Digit)

WW = Production Week (Two Digits)

### ORDERING INFORMATION

Device	Package	Shipping†
CAT3649HV3-GT2	TQFN-16 (Pb-Free)	2000 / Tape & Reel

†For information on tape and reel specifications, including part orientation and tape sizes, please refer to our Tape and Reel Packaging Specification Brochure, BRD8011/D.

# CAT3649

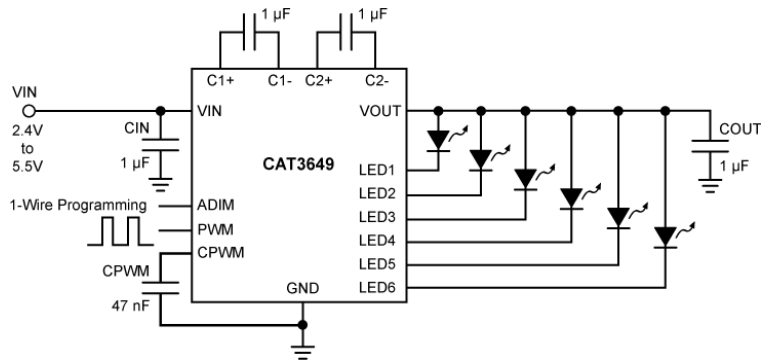

Figure 1. Typical Application Circuit

Table 1. ABSOLUTE MAXIMUM RATINGS

Parameter	Rating	Unit
VIN, LEDx, C1±, C2±, PWM, ADIM, CPWM voltage	GND–0.3 to 6	V
VOUT	GND–0.3 to 7	V
Storage Temperature Range	–65 to +160	°C
Junction Temperature Range	–40 to +150	°C

Stresses exceeding those listed in the Maximum Ratings table may damage the device. If any of these limits are exceeded, device functionality should not be assumed, damage may occur and reliability may be affected.

Table 2. RECOMMENDED OPERATING CONDITIONS

Parameter	Rating	Unit
VIN	2.4 to 5.5	V
Ambient Temperature Range	–40 to +85	°C
LED pin Current range	0 to 25	mA

Functional operation above the stresses listed in the Recommended Operating Ranges is not implied. Extended exposure to stresses beyond the Recommended Operating Ranges limits may affect device reliability.

Table 3. RECOMMENDED ADIM, PWM TIMING (For  $2.4\text{ V} \leq V_{IN} \leq 5.5\text{ V}$ , over full ambient temperature range  $-40^\circ\text{C}$  to  $+85^\circ\text{C}$ .)

Parameter	Symbol	Conditions	Min	Typ	Max	Units
ADIM program low time	$T_{LO}$		0.2		2000	$\mu\text{s}$
ADIM program high time	$T_{HI}$		0.2			$\mu\text{s}$
ADIM to LED current settling time	$T_{LED}$	No CPWM capacitor		40		$\mu\text{s}$
ADIM or PWM low time to shutdown	$T_{PWRDWN}$		12.5	20	30	ms
PWM to VOUT delay time	$T_{PWM\ VOUT}$			40		$\mu\text{s}$
PWM maximum frequency	$F_{PWM\ MAX}$			200		kHz
PWM minimum duty cycle	$DC_{PWM\ MIN}$	100 kHz PWM frequency		1		%

# CAT3649

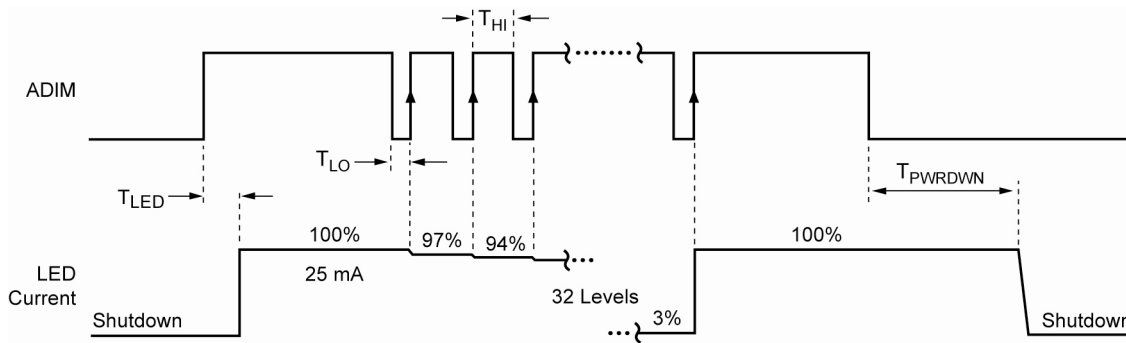

Figure 2. ADIM Dimming Timing Diagram (no CPWM, PWM high)

Table 4. ELECTRICAL OPERATING CHARACTERISTICS (Notes 2 and 3)

Parameter	Symbol	Conditions	Min	Typ	Max	Unit
Quiescent Current (excluding load)	$I_Q$	1x mode 1.33x mode, $V_{IN} = 3V$ 1.5x mode, $V_{IN} = 2.8V$ 2x mode, $V_{IN} = 2.6V$		1.4 2.2 2.7 2.8	2 4 4 4	mA
Shutdown Current	$I_{QSHDN}$	$V_{ADIM} = 0V$			1	$\mu A$
LED Current Setting	$I_{LED-SET}$	After ADIM is first enabled (full scale LED current)		25		mA
LED Current Accuracy	$I_{LED-ACC}$	$(I_{LEDx} - I_{NOMINAL}) / I_{NOMINAL}$ 25 mA $I_{LED}$ setting	-10	$\pm 2$	+10	%
LED Channel Matching	$I_{LED-DEV}$	$(I_{LED} - I_{LEDAVG}) / I_{LEDAVG}$ 25 mA $I_{LED}$ setting	-5	$\pm 1.5$	+5	%
CPWM Pin Regulated Voltage	$V_{CPWM}$	$V_{PWM} = V_{IN}$		0.6		V
Output Resistance (open loop)	$R_{OUT}$	1x mode 1.33x mode, $V_{IN} = 3V$ 1.5x mode, $V_{IN} = 2.7V$ 2x mode, $V_{IN} = 2.4V$		0.8 5 5 10		$\Omega$
Charge Pump Frequency	$F_{OSC}$	1.33x and 2x mode 1.5x mode	0.8 1	1 1.3	1.3 1.6	MHz
Output short circuit Current Limit	$I_{SC\_MAX}$	$V_{OUT} < 0.5V$		50		mA
Input Current Limit	$I_{IN\_MAX}$	$V_{OUT} > 1V$ , 1x mode		250		mA
1x to 1.33x Transition Thresholds at any LED pin	$V_{LEDTH}$	25 mA LED current per channel		100		mV
ADIM and PWM Pins - Pull-down resistance - Logic High Level - Logic Low Level	$R_{PD}$ $V_{HI}$ $V_{LO}$		1.3	20	0.4	$M\Omega$ V V
Thermal Shutdown	$T_{SD}$			150		$^{\circ}C$
Thermal Hysteresis	$T_{HYS}$			20		$^{\circ}C$
Undervoltage lockout (UVLO) threshold	$V_{UVLO}$			2.0		V

Product parametric performance is indicated in the Electrical Characteristics for the listed test conditions, unless otherwise noted. Product performance may not be indicated by the Electrical Characteristics if operated under different conditions.

2. Typical values are at  $V_{IN} = 3.6V$ , PWM = ADIM = High,  $T_{AMB} = 25^{\circ}C$ .

3. Min and Max values are over recommended operating conditions unless specified otherwise.

# CAT3649

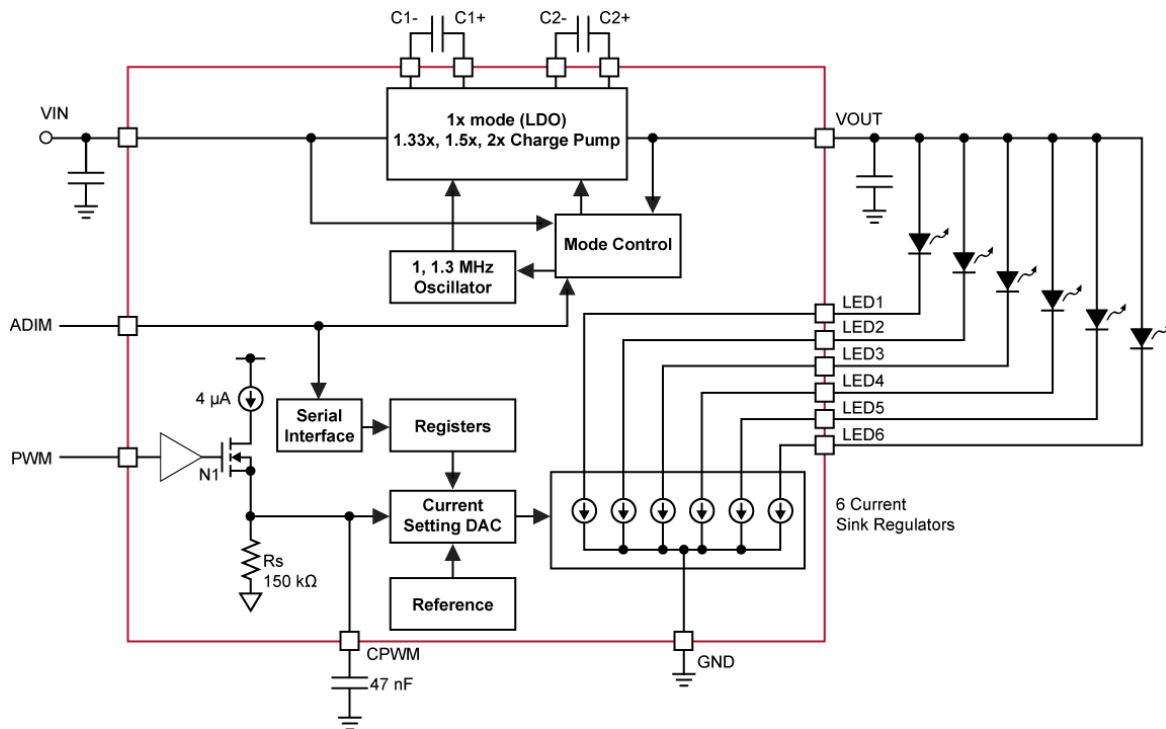

Figure 3. Functional Block Diagram

## Basic Operation

At power-up, the CAT3649 starts operating in 1x mode where the output will be approximately equal to the input supply voltage (less any internal voltage losses). If the output voltage is sufficient to regulate all LED currents, the device remains in 1x operating mode.

If the input voltage is insufficient or falls to a level where the regulated currents cannot be maintained, the device automatically switches into 1.33x mode. In 1.33x mode, the output voltage is approximately equal to 1.33 times the input supply voltage (less any internal voltage losses).

This sequence repeats in the 1.33x and 1.5x mode until the driver enters the 2x mode. In 1.5x mode, the output voltage is approximately equal to 1.5 times the input supply voltage. While in 2x mode, the output is approximately equal to 2 times the input supply voltage.

If the device detects a sufficient input voltage is present to drive all LED currents in 1x mode, it will change automatically back to 1x mode. This only applies for changing back to the 1x mode. The difference between the input voltage when exiting 1x mode and returning to 1x mode is called the 1x mode transition hysteresis ( $V_{HYS}$ ) and is about 300 mV.

TYPICAL PERFORMANCE CHARACTERISTICS

( $V_{IN} = 3.6\text{ V}$ ,  $PWM = V_{IN}$ ,  $I_{OUT} = 120\text{ mA}$  (6 LEDs at 20 mA),  $C_{IN} = C_{OUT} = C_1 = C_2 = 1\ \mu\text{F}$ ,  $C_{PWM} = 47\text{ nF}$ ,  $T_{AMB} = 25^\circ\text{C}$  unless otherwise specified.)

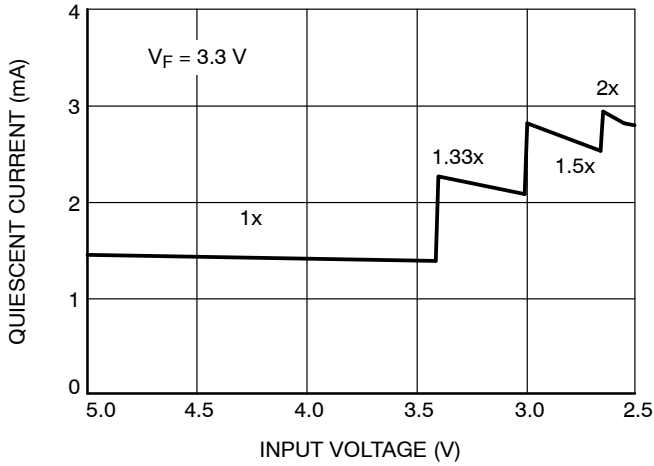

Figure 4. Quiescent Current vs. Input Voltage

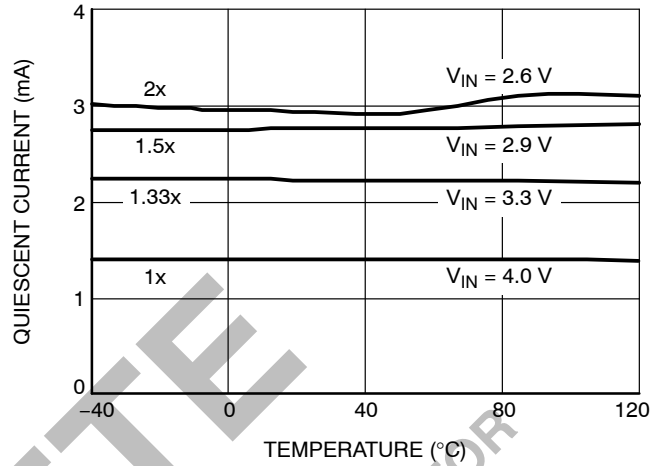

Figure 5. Quiescent Current vs. Temperature

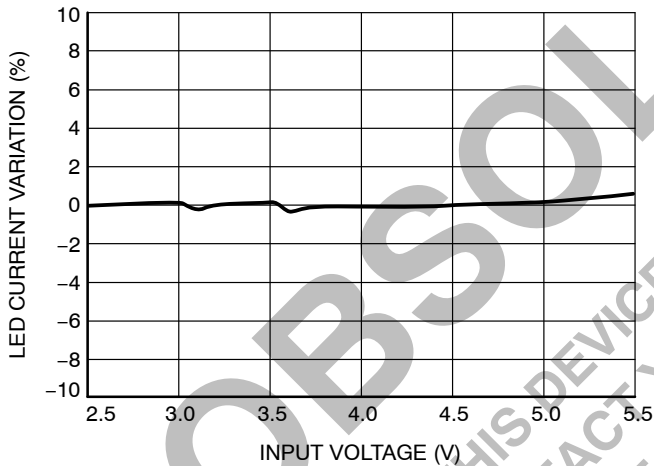

Figure 6. LED Current Change vs. Input Voltage

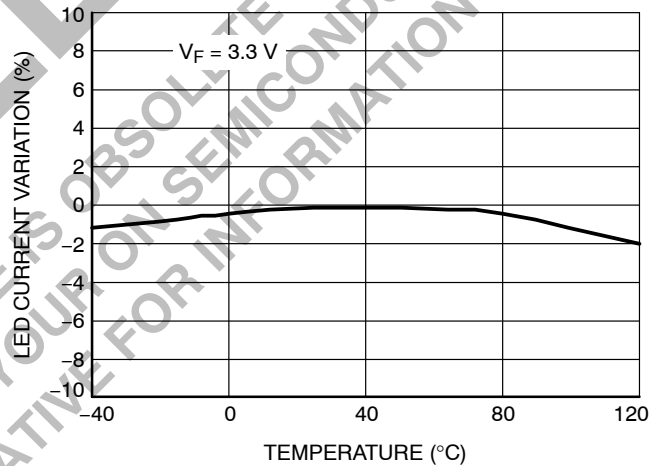

Figure 7. LED Current Change vs. Temperature

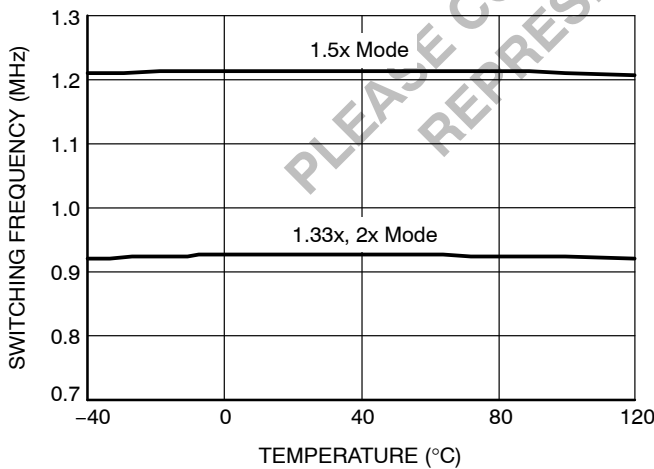

Figure 8. Switching Frequency vs. Temperature

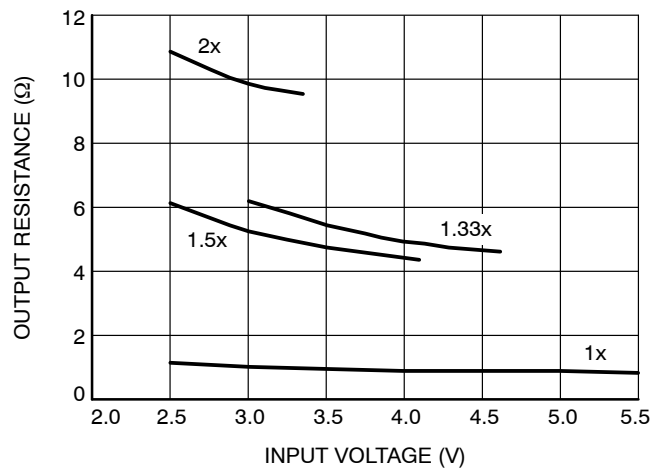

Figure 9. Output Resistance vs. Input Voltage

TYPICAL PERFORMANCE CHARACTERISTICS

( $V_{IN} = 3.6\text{ V}$ ,  $PWM = V_{IN}$ ,  $I_{OUT} = 120\text{ mA}$  (6 LEDs at 20 mA),  $C_{IN} = C_{OUT} = C_1 = C_2 = 1\text{ }\mu\text{F}$ ,  $C_{PWM} = 47\text{ nF}$ ,  $T_{AMB} = 25^\circ\text{C}$  unless otherwise specified.)

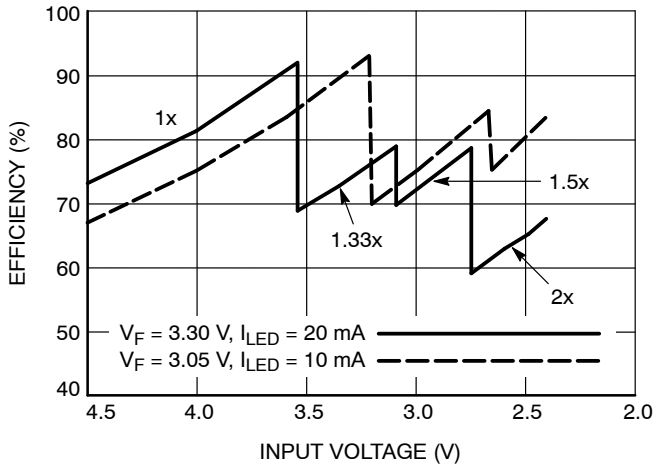

Figure 10. Efficiency vs. Input Voltage

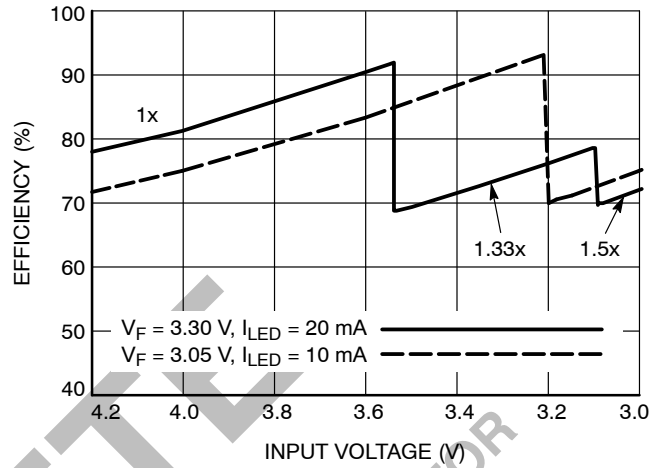

Figure 11. Efficiency vs. Li-Ion Voltage

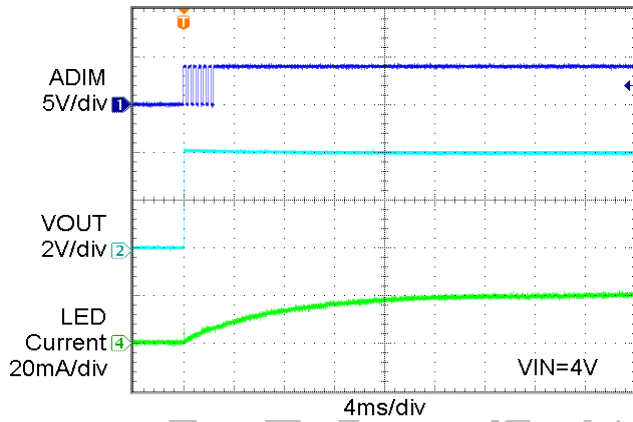

Figure 12. Power Up in 1x Mode

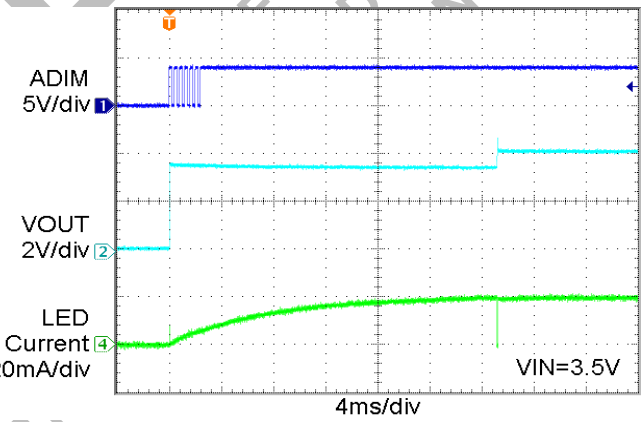

Figure 13. Power Up in 1.33x Mode

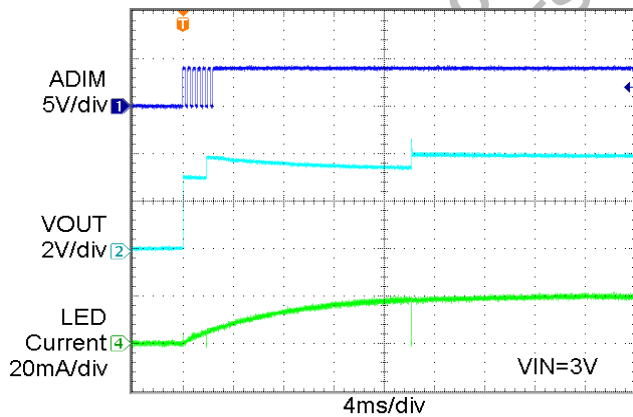

Figure 14. Power Up in 1.5x Mode

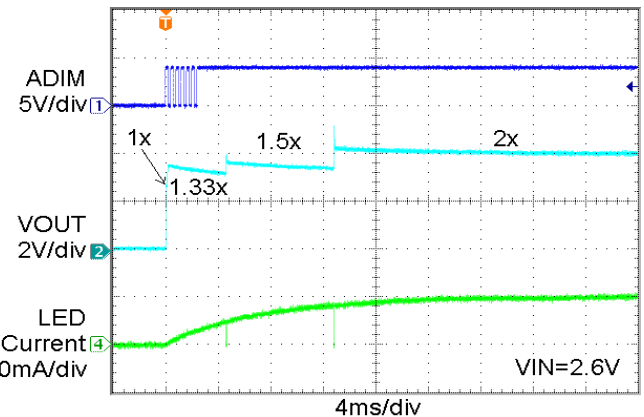

Figure 15. Power Up in 2x Mode

TYPICAL PERFORMANCE CHARACTERISTICS

( $V_{IN} = 3.6\text{ V}$ ,  $PWM = V_{IN}$ ,  $I_{OUT} = 120\text{ mA}$  (6 LEDs at 20 mA),  $C_{IN} = C_{OUT} = C_1 = C_2 = 1\ \mu\text{F}$ ,  $C_{PWM} = 47\text{ nF}$ ,  $T_{AMB} = 25^\circ\text{C}$  unless otherwise specified.)

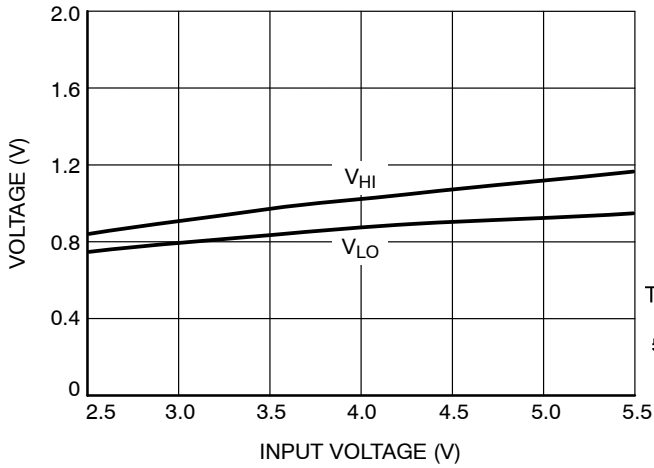

Figure 16. ADIM, PWM  $V_{HI}$   $V_{LO}$  vs.  $V_{IN}$

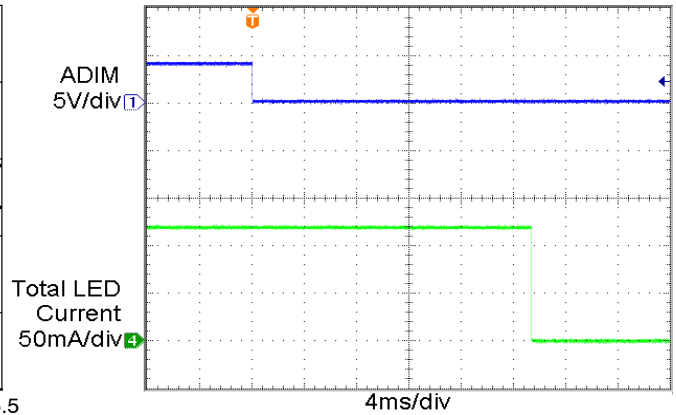

Figure 17. Power Down Delay (1x Mode)

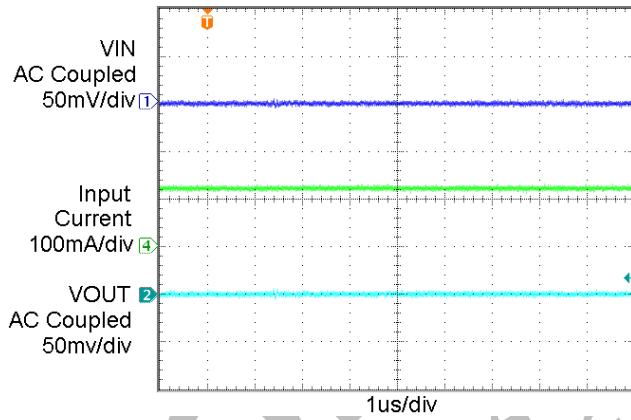

Figure 18. Operating Waveforms in 1x Mode

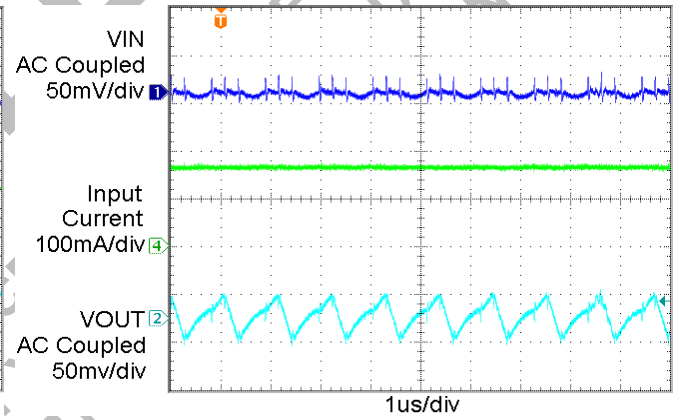

Figure 19. Switching Waveforms in 1.33x Mode

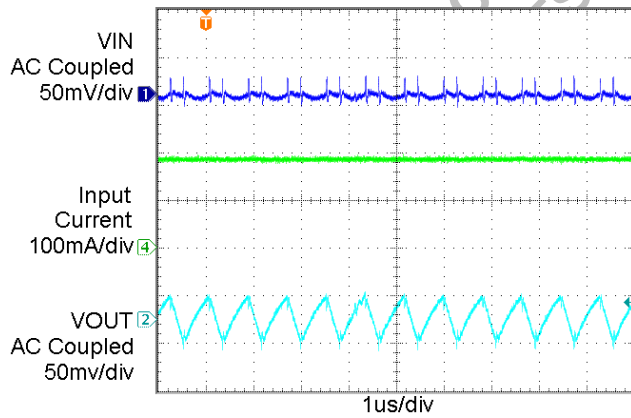

Figure 20. Switching Waveforms in 1.5x Mode

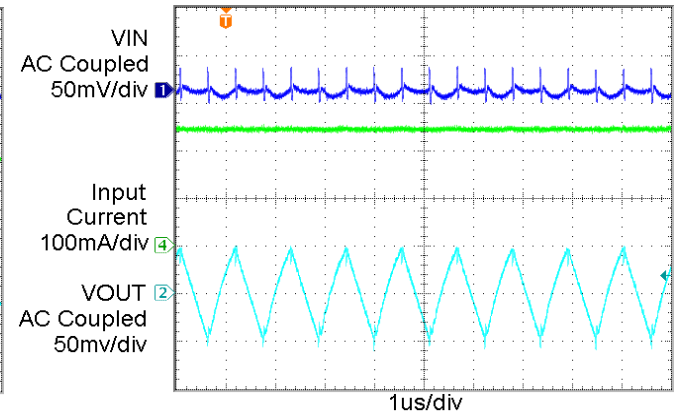

Figure 21. Switching Waveforms in 2x Mode

TYPICAL PERFORMANCE CHARACTERISTICS

( $V_{IN} = 3.6\text{ V}$ ,  $PWM = V_{IN}$ ,  $I_{OUT} = 120\text{ mA}$  (6 LEDs at 20 mA),  $C_{IN} = C_{OUT} = C_1 = C_2 = 1\ \mu\text{F}$ ,  $C_{PWM} = 47\text{ nF}$ ,  $T_{AMB} = 25^\circ\text{C}$  unless otherwise specified.)

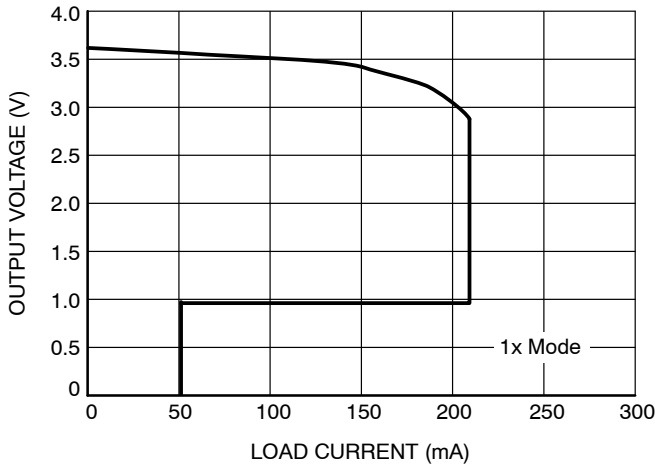

Figure 22. Foldback Current Limit

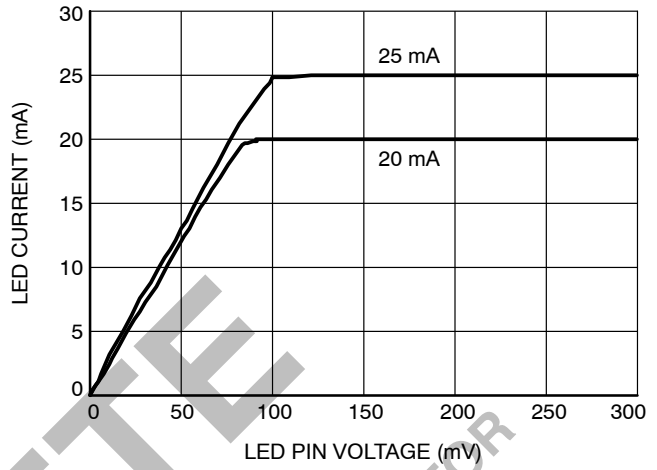

Figure 23. LED Current vs. LED Pin Voltage

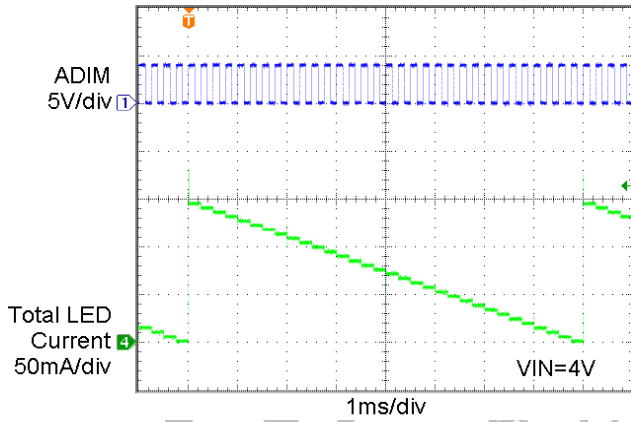

Figure 24. Dimming Waveform

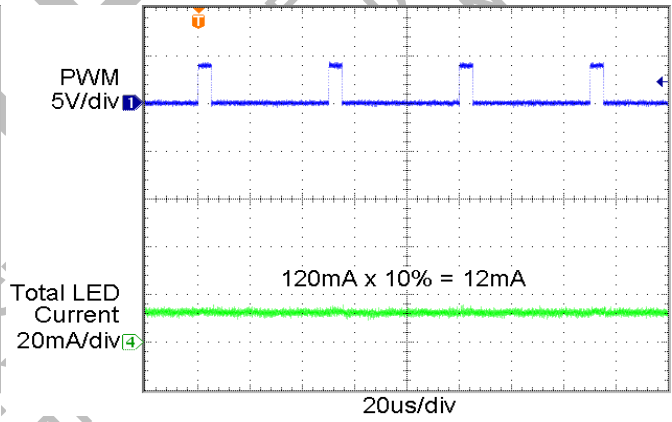

Figure 25. 20 kHz PWM Dimming, 10% Duty Cycle

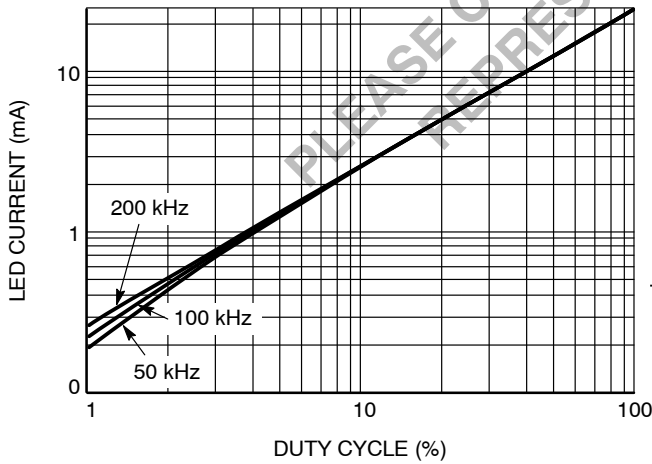

Figure 26. LED Current vs. PWM Duty Cycles

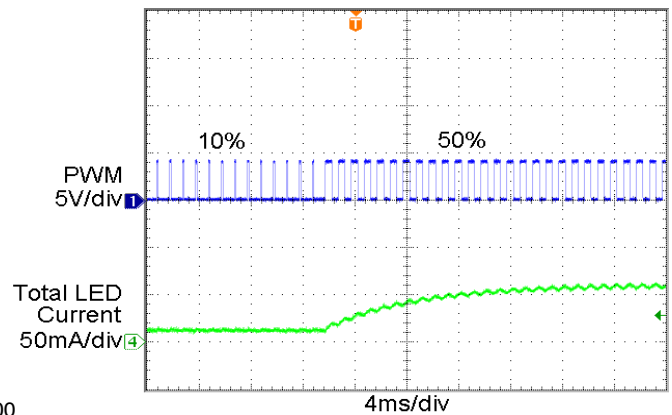

Figure 27. 1 kHz PWM Duty Cycle Increasing 10% to 50%



Table 5. PIN DESCRIPTION

Pin No	Name	Function
1	C1+	Bucket capacitor 1 Positive terminal
2	C1-	Bucket capacitor 1 Negative terminal
3	C2+	Bucket capacitor 2 Positive terminal
4	C2-	Bucket capacitor 2 Negative terminal
5	GND	Ground Reference
6	LED1	LED1 cathode terminal.
7	LED2	LED2 cathode terminal.
8	LED3	LED3 cathode terminal.
9	LED4	LED4 cathode terminal.
10	LED5	LED5 cathode terminal.
11	LED6	LED6 cathode terminal.
12	ADIM	Analog Dimming Control (Active high).
13	PWM	Pulse width modulation 'PWM' (Active high).
14	CPWM	Connect a capacitor for filtering the PWM signal.
15	VOUT	Charge pump output connected to the LED anodes.
16	VIN	Charge pump input, connect to battery or supply.
TAB	GND	Connect to GND on the PCB.

**PIN FUNCTION**

**VIN** is the supply pin for the charge pump. A small 1  $\mu$ F ceramic bypass capacitor is required between the VIN pin and ground near the device. The operating input voltage range is from 2.4 V to 5.5 V. Whenever the input supply falls below the under-voltage threshold (1.8 V), all the LED channels are disabled and the device enters shutdown mode.

**ADIM** is the one wire dimming input for all LED channels. Levels of logic high and logic low are set at 1.3 V and 0.4 V respectively. When ADIM first transitions from low to high, each LED channel current is set to 25 mA. Each subsequent pulse will decrement the current by about 3% from the full scale.

**PWM** is the pulse width modulation input pin. When in logic high condition, the LED current in all six channels equals the programmed level set via ADIM. When PWM is low, the LED current is set to 0 mA. This allows the average LED current to be programmed by the PWM duty cycle. To place the device into “zero current” shutdown mode, the ADIM or PWM pin must be held low for 20 ms typical.

**VOUT** is the charge pump output that is connected to the LED anodes. A small 1  $\mu$ F ceramic bypass capacitor is required between the VOUT pin and ground near the device.

**GND** is the ground reference for the charge pump. The pin must be connected to the ground plane on the PCB.

**C1+, C1-** are connected to each side of the ceramic bucket capacitor C<sub>1</sub>.

**C2+, C2-** are connected to each side of the ceramic bucket capacitor C<sub>2</sub>.

**LED1 to LED6** provide the internal regulated current source for each of the LED cathodes. These pins enter high-impedance zero current state whenever the device is placed in shutdown mode.

**TAB** is the exposed pad underneath the package. For best thermal performance, the tab should be soldered to the PCB and connected to the ground plane.

**CPWM** is the pin for connecting an external capacitor used to filter the PWM signal inside the CAT3649.

**Current Selection**

After power-up and once enabled, the LED current is set initially to the full scale of 25 mA. The number of pulses (n) on the ADIM input decreases the current value as follows:

$$\text{LED current [mA]} = 25 \times \left( \frac{32 - n}{32} \right) \quad (\text{eq. 1})$$

The full scale current is calculated from the above formula with n equal to zero.

The ADIM pin has two primary functions. One function enables and disables the device. The other function is LED current dimming with 32 different levels by pulsing the input signal, as shown on Figure 28. On each consecutive pulse rising edge, the LED current is decreased by about 3.1% (1/32<sup>th</sup> of the full scale value). After 31 pulses, the LED current is 3.1% of the full scale current (lowest level). On the following pulse, the LED current goes back to full scale.

Each pulse width should be between 200 ns and 100 μs. Pulses faster than the minimum T<sub>LO</sub> may be ignored and filtered by the device. Pulses longer than the maximum T<sub>LO</sub> may shutdown the device. By pulsing the ADIM signal at high frequency, the LED current can quickly be set to zero.

The LED driver enters a “zero current” shutdown mode if ADIM is held low for longer than 30 ms.

The dimming level is set by the number of pulses on the ADIM after the power-up, as shown in Table 6.

**Table 6. DIMMING LEVELS**

LED Current (Typical) [mA]	Dimming Pulses [n]
25.0	0
24.2	1
23.4	2
22.6	3
21.8	4
21.0	5
20.2	6
19.4	7
18.6	8
17.8	9
17.0	10
16.2	11
15.3	12
14.6	13
13.8	14
13.0	15
12.3	16
11.5	17
10.7	18
9.9	19
9.1	20
8.3	21
7.5	22
6.7	23
5.9	24
5.1	25
4.3	26
3.6	27
2.7	28
2.0	29
1.2	30
0.4	31
25	32

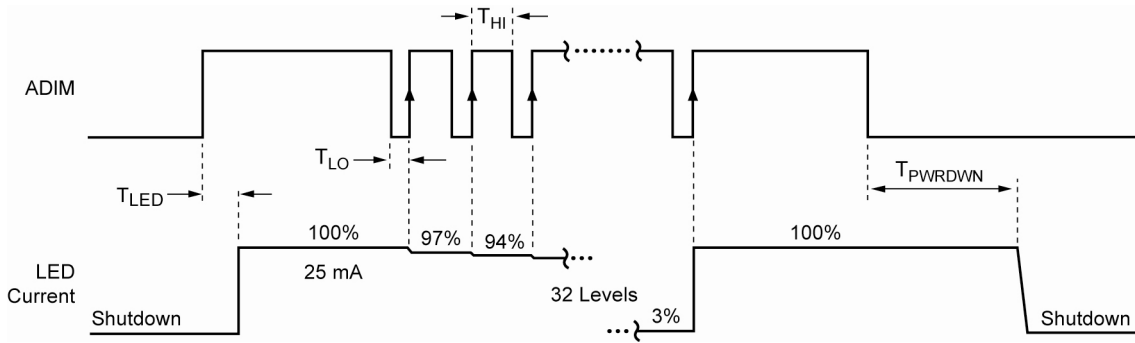

Figure 28. ADIM Dimming Timing Diagram (no  $C_{PWM}$ , PWM high)

**$C_{PWM}$  Filtering Capacitor**

The PWM input signal controls the LED current proportionally to its duty cycle. When the LED driver operates in PWM dimming mode, the  $C_{PWM}$  capacitor minimizes the LED current ripple. This prevents audio noise from the LED driver output capacitors as the PWM signal is converted into a near DC current internally. The PWM input is a logic input and the amplitude of the PWM signal does not affect the LED current. An internal  $4 \mu A$  current source is charging the  $C_{PWM}$  capacitor when the PWM input is high until it reaches a maximum voltage; see Figure 29 block diagram. The internal resistor  $R$  ( $150 \text{ k}\Omega$ ) and external capacitor  $C_{PWM}$  act as a low pass filter with a cut-off frequency  $f_C = 1/2\pi R C_{PWM}$ .

To minimize the ripple current, we recommend the PWM frequency  $f_{PWM}$  to be at least 40 times greater than the cut-off frequency  $f_C$ :

$$f_{PWM} \geq 40 \times f_C \text{ or} \tag{eq. 2}$$

$$C_{PWM} \geq \frac{40}{(2\pi R f_{PWM})} \tag{eq. 3}$$

For example for  $f_{PWM} = 1 \text{ kHz}$ , the capacitor value is:

$$C_{PWM} \geq \frac{40}{(2\pi \times 150 \times 10^3 \times 10^3)} = 42 \text{ nF} \tag{eq. 4}$$

We recommend a  $47 \text{ nF}$  capacitor  $C_{PWM}$  compatible for any PWM frequency between  $1 \text{ kHz}$  and  $200 \text{ kHz}$ . For PWM frequency below  $1 \text{ kHz}$ , the above formula will provide the recommended capacitor value.

The  $C_{PWM}$  capacitor affects the power-up time which is the time to reach the nominal LED current. The power-up time ( $t_{PU}$ ) is proportional to the  $C_{PWM}$  capacitor value and can be calculated as follows.

$$t_{PU} \approx C_{PWM} \times 3 \times 10^5 \tag{eq. 5}$$

For example, for  $C_{PWM} = 47 \text{ nF}$ ,  $t_{PU}$  is about  $15 \text{ ms}$ .

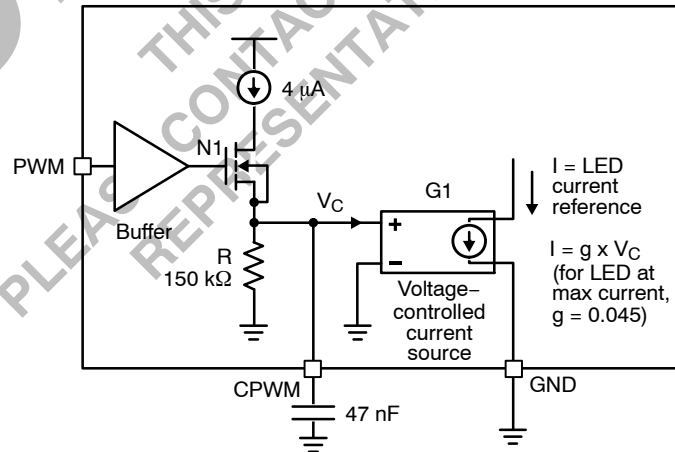
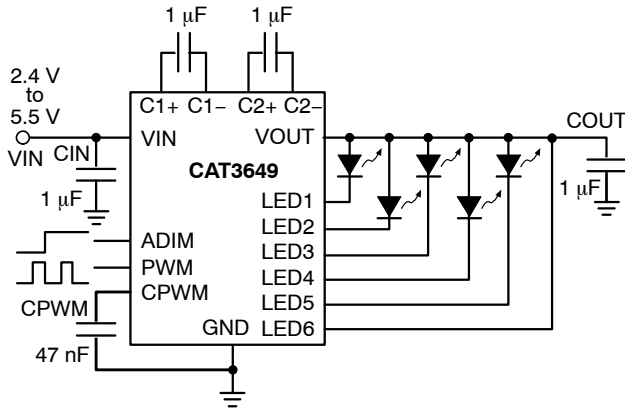

Figure 29. PWM Circuit Block Diagram

**Unused LED Channels**

For applications with five LEDs or less, it is required to tie the unused LED pin(s) directly to VOUT (see Figure 30).



**Figure 30. Application with 5 LEDs**

**Protection Modes**

As soon as the output voltage (V<sub>OUT</sub>) exceeds about 6 V, the driver resets itself and re-evaluates the mode.

The driver supports automatic LED detection for both Open LED and Short LED conditions. This feature disables any unused channels (by connecting the LED pins to VOUT) or during an LED Short condition. The LED detection is always active, during power-up and in normal operation.

**OPEN LED Detection**

When an LED channel becomes open-circuit, the device will go into charge pump mode and drive the output (VOUT) above 4.5 V. If that channel is still not working at VOUT greater than 4.5 V, the channel is locked out from signaling a charge pump mode change and the device returns to normal operation like a 5-channel device. If an Open LED condition is removed, the device will resume normal operation.

**SHORT LED Detection**

If the LED forward voltage (V<sub>F</sub> = V<sub>OUT</sub> - LED pin voltage) is less than 1 V, the channel is disabled and removed from signaling charge pump mode changes. A 5 µA (typical) test current is placed in the (shorted) channel. In case the LED short goes away and V<sub>F</sub> is higher than 1 V, the channel resumes normal operation.

**Thermal Protection**

If the die temperature exceeds +150°C, the driver will enter a thermal protection shutdown mode. When the device temperature drops by about 20°C, the device will resume normal operation.

**LED Selection**

LEDs with forward voltages (V<sub>F</sub>) ranging from 1.3 V to 3.8 V may be used. Selecting LEDs with lower V<sub>F</sub> is recommended in order to keep the driver in 1x mode longer as the battery voltage decreases. For example, if a white LED with a 3.3 V V<sub>F</sub> is selected over one with 3.5 V V<sub>F</sub>, the driver will stay in 1x mode for lower supply voltage of 0.2 V. This extends battery life.

**External Components**

The driver requires four external 1 µF ceramic capacitors for decoupling input, output, and for the charge pump. Both capacitors type X5R and X7R are recommended for the LED driver application. In all charge pump modes, the input current ripple is kept very low by design and an input bypass capacitor of 1 µF is sufficient.

In 1x mode, the device operates in linear mode and does not introduce switching noise back onto the supply.

**Recommended Layout**

In charge pump mode, the driver switches internally at a high frequency. It is recommended to minimize trace length to all four capacitors. A ground plane should cover the area under the driver IC as well as the bypass capacitors. Short connection to ground on capacitors C<sub>IN</sub> and C<sub>OUT</sub> can be implemented with the use of multiple via. A copper area matching the TQFN exposed pad (TAB) must be connected to the ground plane underneath. The use of multiple via improves the package heat dissipation.

# CAT3649

## PACKAGE DIMENSIONS

TQFN16, 3x3  
CASE 510AD  
ISSUE A

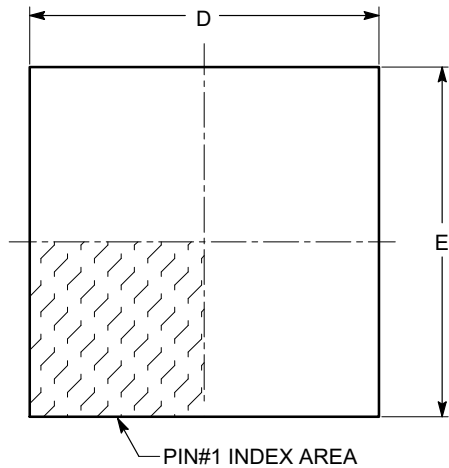

TOP VIEW

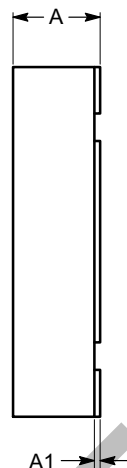

SIDE VIEW

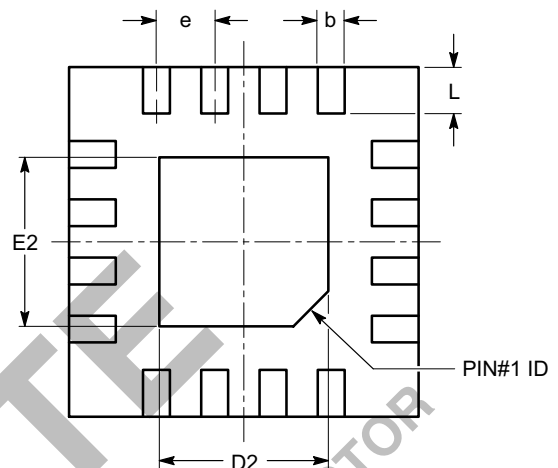

BOTTOM VIEW

SYMBOL	MIN	NOM	MAX
A	0.70	0.75	0.80
A1	0.00	0.02	0.05
A3	0.20 REF		
b	0.18	0.25	0.30
D	2.90	3.00	3.10
D2	1.40	---	1.80
E	2.90	3.00	3.10
E2	1.40	---	1.80
e	0.50 BSC		
L	0.30	0.40	0.50

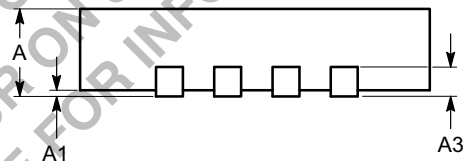

FRONT VIEW

**Notes:**

- (1) All dimensions are in millimeters.
- (2) Complies with JEDEC MO-220.
4. All packages are RoHS-compliant (Lead-free, Halogen-free).
5. The standard lead finish is NiPdAu.
6. For additional package and temperature options, please contact your nearest ON Semiconductor Sales office.

ON Semiconductor and the are registered trademarks of Semiconductor Components Industries, LLC (SCILLC) or its subsidiaries in the United States and/or other countries. SCILLC owns the rights to a number of patents, trademarks, copyrights, trade secrets, and other intellectual property. A listing of SCILLC's product/patent coverage may be accessed at [www.onsemi.com/site/pdf/Patent-Marking.pdf](http://www.onsemi.com/site/pdf/Patent-Marking.pdf). SCILLC reserves the right to make changes without further notice to any products herein. SCILLC makes no warranty, representation or guarantee regarding the suitability of its products for any particular purpose, nor does SCILLC assume any liability arising out of the application or use of any product or circuit, and specifically disclaims any and all liability, including without limitation special, consequential or incidental damages. "Typical" parameters which may be provided in SCILLC data sheets and/or specifications can and do vary in different applications and actual performance may vary over time. All operating parameters, including "Typicals" must be validated for each customer application by customer's technical experts. SCILLC does not convey any license under its patent rights nor the rights of others. SCILLC products are not designed, intended, or authorized for use as components in systems intended for surgical implant into the body, or other applications intended to support or sustain life, or for any other application in which the failure of the SCILLC product could create a situation where personal injury or death may occur. Should Buyer purchase or use SCILLC products for any such unintended or unauthorized application, Buyer shall indemnify and hold SCILLC and its officers, employees, subsidiaries, affiliates, and distributors harmless against all claims, costs, damages, and expenses, and reasonable attorney fees arising out of, directly or indirectly, any claim of personal injury or death associated with such unintended or unauthorized use, even if such claim alleges that SCILLC was negligent regarding the design or manufacture of the part. SCILLC is an Equal Opportunity/Affirmative Action Employer. This literature is subject to all applicable copyright laws and is not for resale in any manner.

**PUBLICATION ORDERING INFORMATION**

**LITERATURE FULFILLMENT:**  
Literature Distribution Center for ON Semiconductor  
P.O. Box 5163, Denver, Colorado 80217 USA  
**Phone:** 303-675-2175 or 800-344-3860 Toll Free USA/Canada  
**Fax:** 303-675-2176 or 800-344-3867 Toll Free USA/Canada  
**Email:** [orderlit@onsemi.com](mailto:orderlit@onsemi.com)

**N. American Technical Support:** 800-282-9855 Toll Free USA/Canada  
**Europe, Middle East and Africa Technical Support:**  
Phone: 421 33 790 2910  
**Japan Customer Focus Center**  
Phone: 81-3-5817-1050

**ON Semiconductor Website:** [www.onsemi.com](http://www.onsemi.com)  
**Order Literature:** <http://www.onsemi.com/orderlit>  
For additional information, please contact your local Sales Representative

# Mouser Electronics

Authorized Distributor

Click to View Pricing, Inventory, Delivery & Lifecycle Information:

[onsemi:](#)

[CAT3649HV3-GT2](#)