



Is Now Part of



**ON Semiconductor®**

To learn more about ON Semiconductor, please visit our website at  
[www.onsemi.com](http://www.onsemi.com)

Please note: As part of the Fairchild Semiconductor integration, some of the Fairchild orderable part numbers will need to change in order to meet ON Semiconductor's system requirements. Since the ON Semiconductor product management systems do not have the ability to manage part nomenclature that utilizes an underscore (\_), the underscore (\_) in the Fairchild part numbers will be changed to a dash (-). This document may contain device numbers with an underscore (\_). Please check the ON Semiconductor website to verify the updated device numbers. The most current and up-to-date ordering information can be found at [www.onsemi.com](http://www.onsemi.com). Please email any questions regarding the system integration to [Fairchild\\_questions@onsemi.com](mailto:Fairchild_questions@onsemi.com).

ON Semiconductor and the ON Semiconductor logo are trademarks of Semiconductor Components Industries, LLC dba ON Semiconductor or its subsidiaries in the United States and/or other countries. ON Semiconductor owns the rights to a number of patents, trademarks, copyrights, trade secrets, and other intellectual property. A listing of ON Semiconductor's product/patent coverage may be accessed at [www.onsemi.com/site/pdf/Patent-Marking.pdf](http://www.onsemi.com/site/pdf/Patent-Marking.pdf). ON Semiconductor reserves the right to make changes without further notice to any products herein. ON Semiconductor makes no warranty, representation or guarantee regarding the suitability of its products for any particular purpose, nor does ON Semiconductor assume any liability arising out of the application or use of any product or circuit, and specifically disclaims any and all liability, including without limitation special, consequential or incidental damages. Buyer is responsible for its products and applications using ON Semiconductor products, including compliance with all laws, regulations and safety requirements or standards, regardless of any support or applications information provided by ON Semiconductor. "Typical" parameters which may be provided in ON Semiconductor data sheets and/or specifications can and do vary in different applications and actual performance may vary over time. All operating parameters, including "Typicals" must be validated for each customer application by customer's technical experts. ON Semiconductor does not convey any license under its patent rights nor the rights of others. ON Semiconductor products are not designed, intended, or authorized for use as a critical component in life support systems or any FDA Class 3 medical devices or medical devices with a same or similar classification in a foreign jurisdiction or any devices intended for implantation in the human body. Should Buyer purchase or use ON Semiconductor products for any such unintended or unauthorized application, Buyer shall indemnify and hold ON Semiconductor and its officers, employees, subsidiaries, affiliates, and distributors harmless against all claims, costs, damages, and expenses, and reasonable attorney fees arising out of, directly or indirectly, any claim of personal injury or death associated with such unintended or unauthorized use, even if such claim alleges that ON Semiconductor was negligent regarding the design or manufacture of the part. ON Semiconductor is an Equal Opportunity/Affirmative Action Employer. This literature is subject to all applicable copyright laws and is not for resale in any manner.

# FSDM0465RB

## Green Mode Fairchild Power Switch (FPS™)

### Features

- Internal Avalanche Rugged SenseFET
- Advanced Burst-Mode Operation Consumes Under One W at 240VAC & 0.5W Load
- Precision Fixed Operating Frequency (66kHz)
- Internal Start-up Circuit
- Improved Pulse by Pulse Current Limiting
- Over Voltage Protection (OVP) : Auto-Restart
- Over Load Protection (OLP): Auto-Restart
- Internal Thermal Shutdown (TSD) : Auto-Restart
- Under Voltage Lock Out (UVLO) with Hysteresis
- Low Operating Current (2.5mA)
- Built-in Soft Start

### Application

- SMPS for LCD monitor and STB
- Adapter

### Related Application Notes

- **AN4137** - Design Guidelines for Off-line Flyback Converters Using Fairchild Power Switch (FPS)
- **AN4140** - Transformer Design Consideration for Off-line Flyback Converters Using Fairchild Power Switch
- **AN4141** - Troubleshooting and Design Tips for Fairchild Power Switch Flyback Applications
- **AN4148** - Audible Noise Reduction Techniques for FPS Applications

### Description

The FSDM0465RB is an integrated Pulse Width Modulator (PWM) and SenseFET specifically designed for high performance offline Switch Mode Power Supplies (SMPS) with minimal external components. This device is an integrated high voltage power switching regulator which combines a rugged avalanche, SenseFET with a current mode PWM control block. The PWM controller includes integrated fixed frequency oscillator, under voltage lockout, leading edge blanking (LEB), optimized gate driver, internal soft start, temperature compensated precise current sources for a loop compensation and self protection circuitry. Compared with a discrete MOSFET and PWM controller solution, the PWM/FSDMRB can reduce total cost, component count, size and weigh, while simultaneously increasing efficiency, productivity, and system reliability. This device provides a basic platform well suited for cost-effective designs of flyback converters.

OUTPUT POWER TABLE (4)				
PRODUCT	230VAC ±15% <sup>(3)</sup>		85-265VAC	
	Adapt-er <sup>(1)</sup>	Open Frame <sup>(2)</sup>	Adapt-er <sup>(1)</sup>	Open Frame <sup>(2)</sup>
FSDM0465RB	48W	56W	40W	48W
FSDM0565RB	60W	70W	50W	60W
FSDM07652RB	70W	80W	60W	70W
FSDM12652RB	90W	110W	80W	90W

**Table 1. Maximum Output Power**

#### Notes:

1. Typical continuous power in a non-ventilated enclosed adapter measured at 50°C ambient.
2. Maximum practical continuous power in an open frame design at 50°C ambient.
3. 230 VAC or 100/115 VAC with doubler.
4. The junction temperature can limit the maximum output power.

### Typical Circuit

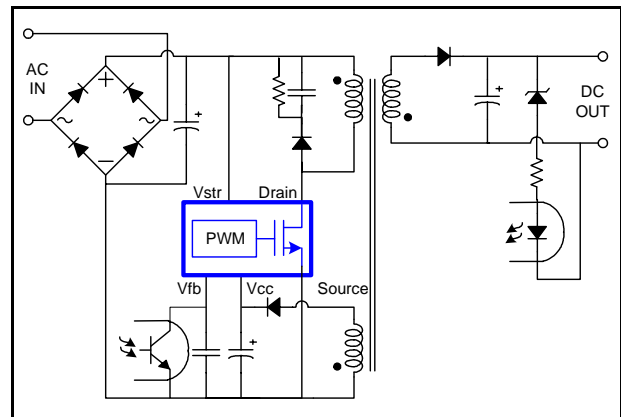

**Figure 1. Typical Flyback Application**



## Pin Description

Pin Number	Pin Name	Pin Function Description
1	Drain	This pin is the high voltage power SenseFET drain. It is designed to drive the transformer directly.
2	GND	This pin is the control ground and the SenseFET source.
3	Vcc	This pin is the positive supply voltage input. During start up, the power is supplied by an internal high voltage current source that is connected to the Vstr pin. When Vcc reaches 12V, the internal high voltage current source is disabled and the power is supplied from the auxiliary transformer winding.
4	Vfb	This pin is internally connected to the inverting input of the PWM comparator. The collector of an opto-coupler is typically tied to this pin. For stable operation, a capacitor should be placed between this pin and GND. If the voltage of this pin reaches 6.0V, the over load protection is activated resulting in shutdown of the FPS™.
5	N.C	-
6	Vstr	This pin is connected directly to the high voltage DC link. At startup, the internal high voltage current source supplies internal bias and charges the external capacitor that is connected to the Vcc pin. Once Vcc reaches 12V, the internal current source is disabled.

## Pin Assignments

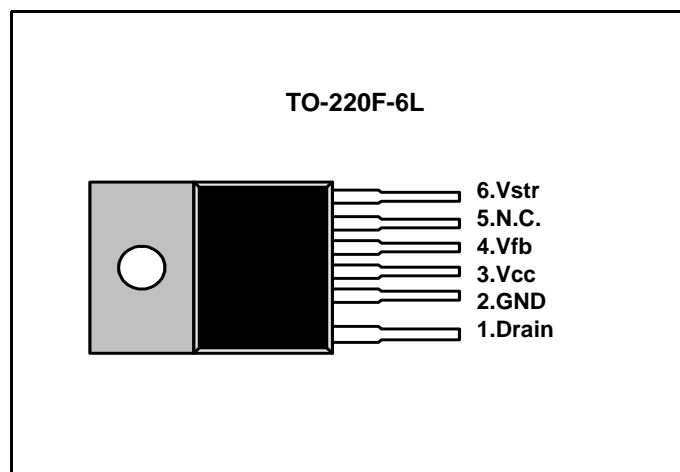

Figure 3. Pin Configuration (Top View)

## Absolute Maximum Ratings

(Ta=25°C, unless otherwise specified)

Parameter	Symbol	Value	Unit
Drain-source Voltage	V <sub>DSS</sub>	650	V
V <sub>str</sub> Max Voltage	V <sub>STR</sub>	650	V
Pulsed Drain Current (T <sub>c</sub> =25°C) <sup>(1)</sup>	I <sub>DM</sub>	9.6	A
Continuous Drain Current (T <sub>c</sub> =25°C) <sup>(2)</sup>	I <sub>D</sub>	2.2	A (rms)
Continuous Drain Current (T <sub>c</sub> =100°C) <sup>(2)</sup>		1.4	A (rms)
Continuous Drain Current* (T <sub>DL</sub> =25°C) <sup>(3)</sup>	I <sub>D</sub> *	4	A (rms)
Single Pulsed Avalanche Energy <sup>(4)</sup>	E <sub>AS</sub>	-	mJ
Supply Voltage	V <sub>CC</sub>	20	V
Input Voltage Range	V <sub>FB</sub>	-0.3 to V <sub>CC</sub>	V
Total Power Dissipation (T <sub>c</sub> =25°C) <sup>(2)</sup>	P <sub>D</sub>	33	W
Operating Junction Temperature	T <sub>j</sub>	Internally limited	°C
Operating Ambient Temperature	T <sub>A</sub>	-25 to +85	°C
Storage Temperature Range	T <sub>STG</sub>	-55 to +150	°C
ESD Capability, HBM Model (All pins except V <sub>str</sub> and V <sub>fb</sub> )	-	2.0 (GND-V <sub>str</sub> /V <sub>fb</sub> =1.5kV)	kV
ESD Capability, Machine Model (All pins except V <sub>str</sub> and V <sub>fb</sub> )	-	300 (GND-V <sub>str</sub> /V <sub>fb</sub> =225V)	V

### Notes:

1. Repetitive Rating: Pulse width limited by maximum junction temperature
2. T<sub>c</sub>: Case Back Surface Temperature (With infinite heat sink)
3. T<sub>DL</sub>: Drain Lead Temperature (With infinite heat sink)
4. L=14mH, starting T<sub>j</sub>=25°C. L=14mH, starting T<sub>j</sub>=25°C

## Thermal Impedance

Parameter	Symbol	Value	Unit
Junction-to-Ambient Thermal	θ <sub>JA</sub>	-	°C/W
Junction-to-Case Thermal	θ <sub>JC</sub> <sup>(1)</sup>	3.78	°C/W

### Notes:

1. Infinite cooling condition - refer to the SEMI G30-88.

## Electrical Characteristics

(Ta = 25°C unless otherwise specified)

Parameter	Symbol	Condition	Min.	Typ.	Max.	Unit
<b>SenseFET SECTION</b>						
Drain Source Breakdown Voltage	BVDSS	VGS = 0V, ID = 250μA	650	-	-	V
Zero Gate Voltage Drain Current	IDSS	VDS = 650V, VGS = 0V	-	-	250	μA
		VDS = 520V VGS = 0V, TC = 125°C	-	-	250	μA
Static Drain Source On Resistance <sup>(1)</sup>	RDS(ON)	VGS = 10V, ID = 2.5A	-	2.2	2.6	Ω
Output Capacitance	COSS	VGS = 0V, VDS = 25V, f = 1MHz	-	60	-	pF
Turn On Delay Time	TD(ON)	VDD = 325V, ID = 3.2A	-	23	-	ns
Rise Time	TR		-	20	-	
Turn Off Delay Time	TD(OFF)		-	65	-	
Fall Time	TF		-	27	-	
<b>CONTROL SECTION</b>						
Initial Frequency	FOSC	VFB = 3V	60	66	72	kHz
Voltage Stability	FSTABLE	13V ≤ VCC ≤ 18V	0	1	3	%
Temperature Stability <sup>(2)</sup>	ΔFOSC	-25°C ≤ Ta ≤ 85°C	0	±5	±10	%
Maximum Duty Cycle	DMAX	-	77	82	87	%
Minimum Duty Cycle	DMIN	-	-	-	0	%
Start Threshold Voltage	VSTART	VFB=GND	11	12	13	V
Stop Threshold Voltage	VSTOP	VFB=GND	7	8	9	V
Feedback Source Current	IFB	VFB=GND	0.7	0.9	1.1	mA
Soft-start Time	TS	Vfb=3	-	10	15	ms
Leading Edge Blanking Time	TLEB	-	-	250	-	ns
<b>BURST MODE SECTION</b>						
Burst Mode Voltages	VBURH	VCC=14V	-	0.7	-	V
	VBURL	VCC=14V	-	0.5	-	V

**Electrical Characteristics** (Continued)

(Ta = 25°C unless otherwise specified)

Parameter	Symbol	Condition	Min.	Typ.	Max.	Unit
<b>PROTECTION SECTION</b>						
Peak Current Limit <sup>(3)</sup>	I <sub>OVER</sub>	V <sub>FB</sub> =5V, V <sub>CC</sub> =14V	1.6	1.8	2.0	A
Over Voltage Protection	V <sub>OVP</sub>	-	18	19	20	V
Thermal Shutdown Temperature <sup>(2)</sup>	T <sub>SD</sub>	-	130	145	160	°C
Shutdown Feedback Voltage	V <sub>SD</sub>	V <sub>FB</sub> ≥ 5.5V	5.5	6.0	6.5	V
Shutdown Delay Current	I <sub>DELAY</sub>	V <sub>FB</sub> =5V	2.8	3.5	4.2	μA
<b>TOTAL DEVICE SECTION</b>						
Startup Current <sup>(4)</sup>	I <sub>start</sub>	V <sub>FB</sub> =GND, V <sub>CC</sub> =11V	-	1	1.3	mA
Operating Supply Current <sup>(4)</sup>	I <sub>OP</sub>	V <sub>FB</sub> =GND, V <sub>CC</sub> =14V	-	2.5	5	mA
	I <sub>OP(MIN)</sub>	V <sub>FB</sub> =GND, V <sub>CC</sub> =10V				
	I <sub>OP(MAX)</sub>	V <sub>FB</sub> =GND, V <sub>CC</sub> =18V				

**Notes:**

1. Pulse test: Pulse width ≤ 300μS, duty ≤ 2%
2. These parameters, although guaranteed at the design, are not tested in mass production.
3. These parameters indicate the inductor current.
4. This parameter is the current flowing into the control IC.

## Typical Performance Characteristics

(These Characteristic Graphs are Normalized at Ta= 25°C)

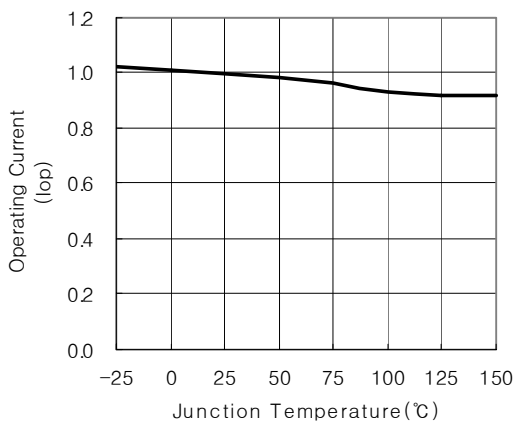

**Operating Current vs. Temp**

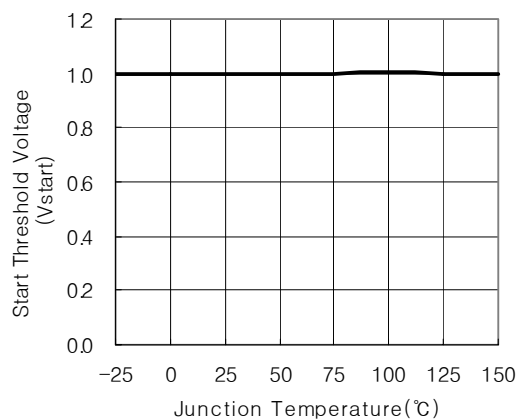

**Start Threshold Voltage vs. Temp**

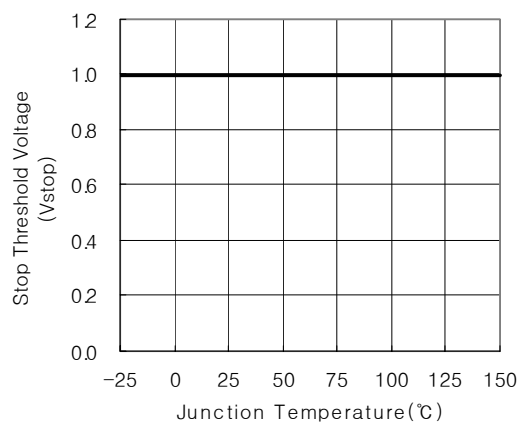

**Stop Threshold Voltage vs. Temp**

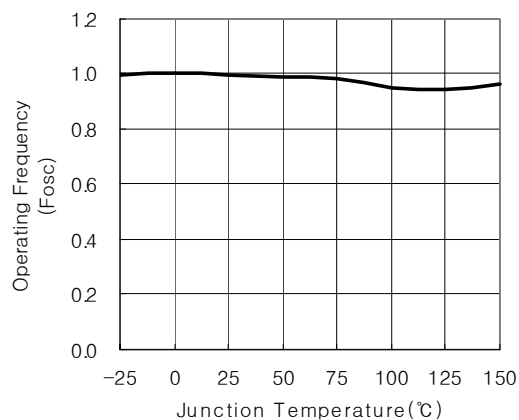

**Operating Frequency vs. Temp**

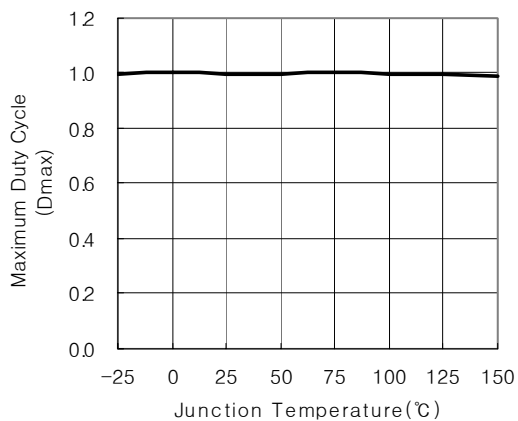

**Maximum Duty vs. Temp**

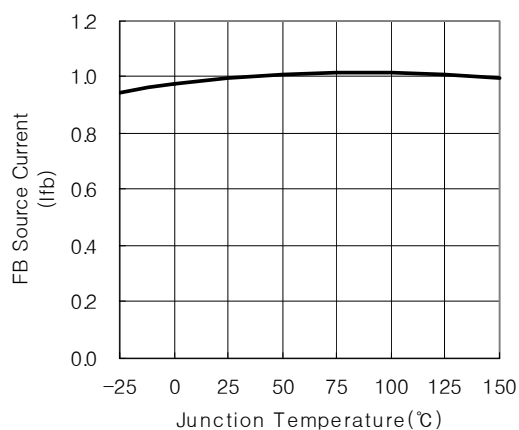

**Feedback Source Current vs. Temp**



## Typical Performance Characteristics (Continued)

(These Characteristic Graphs are Normalized at Ta= 25°C)

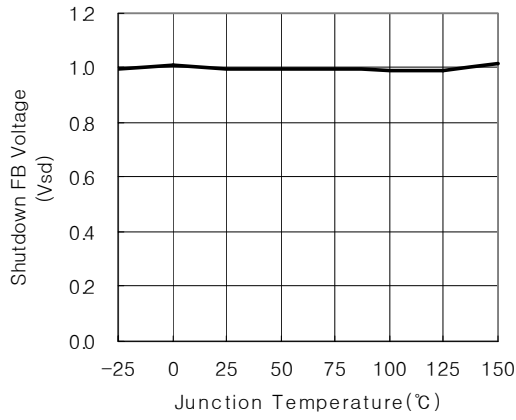

Shutdown Feedback Voltage vs. Temp

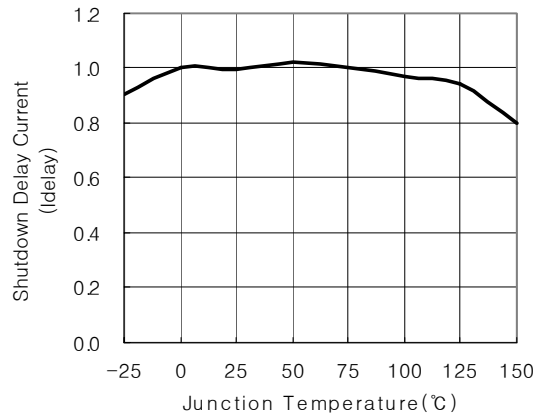

Shutdown Delay Current vs. Temp

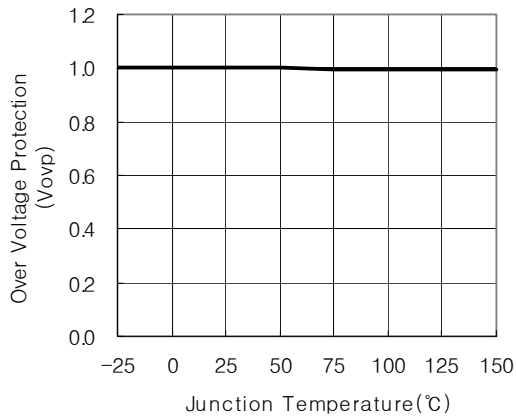

Over Voltage Protection vs. Temp

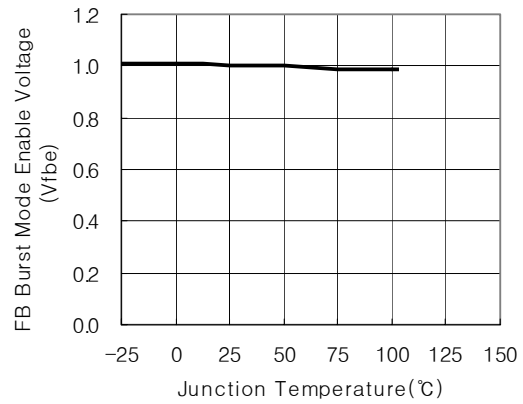

Burst Mode Enable Voltage vs. Temp

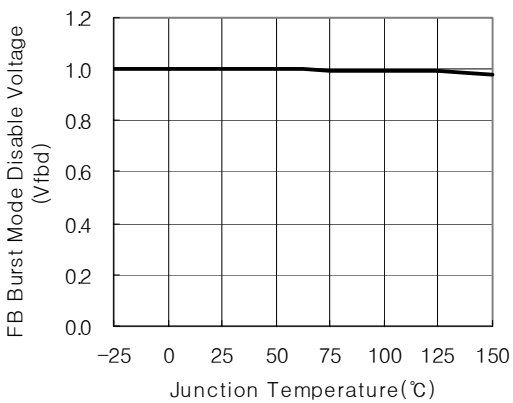

Burst Mode Disable Voltage vs. Temp

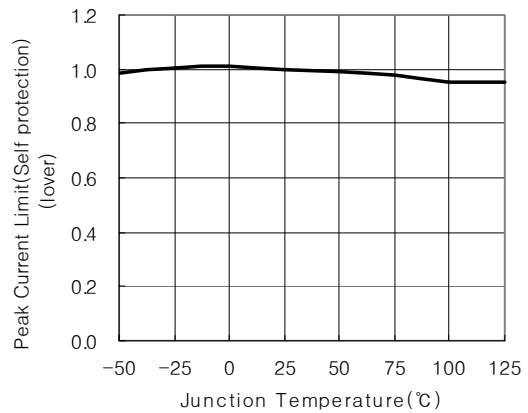

Current Limit vs. Temp

## Typical Performance Characteristics (Continued)

(These Characteristic Graphs are Normalized at Ta= 25°C)

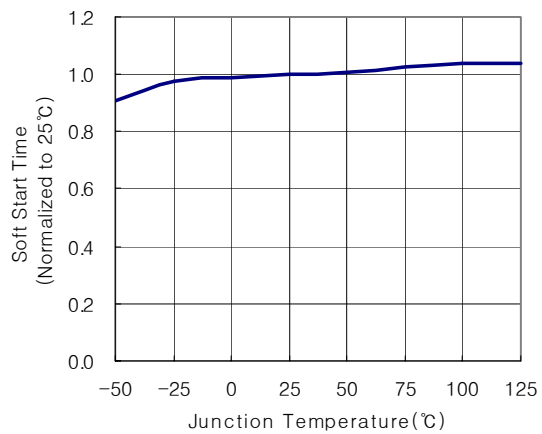

**Soft Start Time vs. Temp**



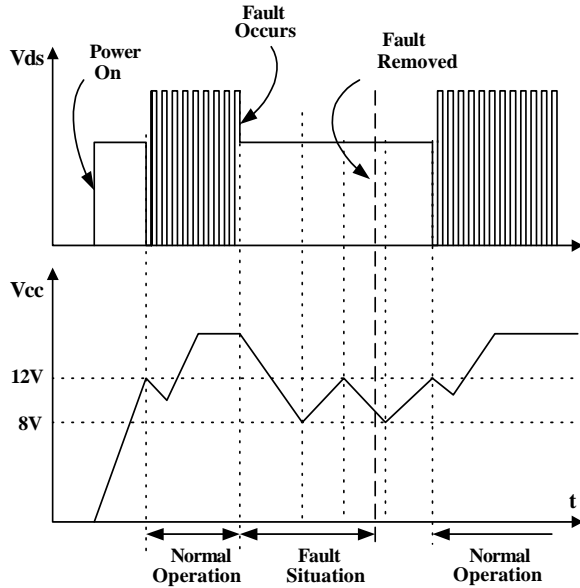

Figure 6. Auto Restart Operation

**3.1 Over Load Protection (OLP):** Overload is defined as the load current exceeding a pre-set level due to an unexpected event. In this situation, the protection circuit should be activated to protect the SMPS.

However, even when the SMPS is operation normally, the over load protection circuit can be activated during the load transition. To avoid this undesired operation, the over load protection circuit is designed to be activated after a specified time to determine whether it is a transient situation or an overload situation.

Because of the pulse-by-pulse current limit capability, the maximum peak current through the SenseFET is limited, and therefore the maximum input power is restricted with a given input voltage. If the output consumes beyond this maximum power, the output voltage ( $V_o$ ) decreases below the set voltage. This reduces the current through the opto-coupler LED, which also reduces the opto-coupler transistor current, thus increasing the feedback voltage ( $V_{fb}$ ).

If  $V_{fb}$  exceeds 2.5V, D1 is blocked and the 3.5uA current source starts to charge  $C_B$  slowly up to  $V_{cc}$ .

In this condition,  $V_{fb}$  continues increasing until it reaches 6V, when the switching operation is terminated as shown in Figure 7. The delay time for shutdown is the time required to charge  $C_B$  from 2.5V to 6.0V with 3.5uA.

In general, a 10 ~ 50 ms delay time is typical for most applications.

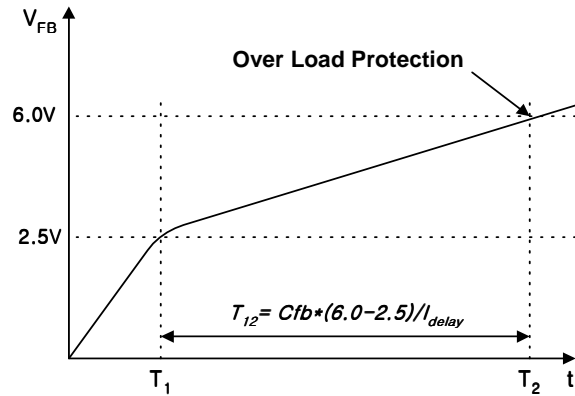

Figure 7. Over Load Protection

**3.2 Over Voltage Protection (OVP):** If the secondary side feedback circuit malfunction or a solder defect caused an open in the feedback path, the current through the opto-coupler transistor becomes almost zero. Then,  $V_{fb}$  climbs up in a similar manner to the over load situation, forcing the preset maximum current to be supplied to the SMPS until the over load protection is activated. Because more energy than required is provided to the output, the output voltage may exceed the rated voltage before the over load protection is activated, resulting in the breakdown of the devices in the secondary side. To prevent this situation, an OVP circuit is employed. In general,  $V_{cc}$  is proportional to the output voltage and the FSDM0465RB uses  $V_{cc}$  instead of directly monitoring the output voltage. If  $V_{cc}$  exceeds 19V, an OVP circuit is activated resulting in the termination of the switching operation. To avoid undesired activation of OVP during normal operation,  $V_{cc}$  should be designed to be below 19V.

**3.3 Thermal Shutdown (TSD):** The SenseFET and the control IC are built in one package. This makes it easy for the control IC to detect the heat generation from the Sense FET. When the temperature exceeds approximately 150°C, the thermal shutdown is activated.

**4. Soft Start:** The FSDM0465RB's internal soft-start circuit slowly increases the PWM comparator's inverting input voltage along with the SenseFET current after it starts up. The typical soft-start time is 10msec. The pulse width to the power switching device is progressively increased to establish the correct working conditions for transformers, inductors, and capacitors. The voltage on the output capacitors is progressively increased with the intention of smoothly establishing the required output voltage. It also helps to prevent transformer saturation and reduce the stress on the secondary diode during startup.

**5. Burst Operation:** To minimize power dissipation in standby mode, the FSDM0465RB enters burst mode operation. As the load decreases, the feedback voltage decreases. As shown in Figure 8, the device automatically enters burst mode when the feedback voltage drops below  $V_{BURL}$ (500mV). At this point switching stops and the output voltages start to drop at a rate dependent on the standby current load. This causes the feedback voltage to rise. Once it passes  $V_{BURH}$ (700mV), switching resumes. The feedback voltage then falls and the process repeats. Burst mode operation alternately enables and disables switching of the power SenseFET thereby reducing switching loss in Standby mode.

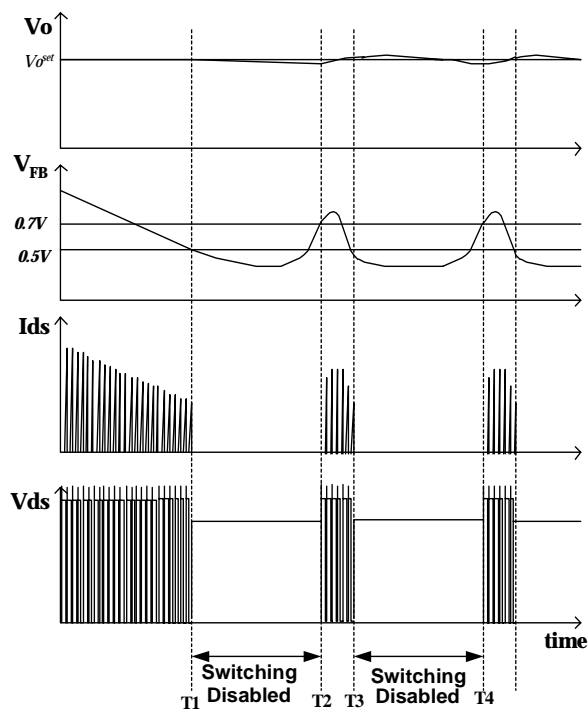

Figure 8. Waveforms of Burst Operation

## Typical application circuit

Application	Output Power	Input Voltage	Output Voltage (Max Current)
LCD Monitor	34W	Universal Input (85-265Vac)	5V (2.0A) 12V (2.0A)

### Features

- High efficiency (>81% at 85Vac input)
- Low zero load power consumption (<300mW at 240Vac input)
- Low standby mode power consumption (<800mW at 240Vac input and 0.3W load)
- Low component count
- Enhanced system reliability through various protection functions
- Internal soft-start (10ms)

### Key Design Notes

- Resistors R102 and R105 are employed to prevent start-up at low input voltage. After startup, there is no power loss in these resistors since the startup pin is internally disconnected after startup.
- The delay time for over load protection is designed to be about 50ms with C106 of 47nF. If a faster triggering of OLP is required, C106 can be reduced to 10nF.
- Zener diode ZD102 is used for a safety test such as UL. When the drain pin and feedback pin are shorted, the zener diode fails and remains short, which causes the fuse (F1) to blow and prevents explosion of the opto-coupler (IC301). This zener diode also increases the immunity against line surges.

### 1. Schematic

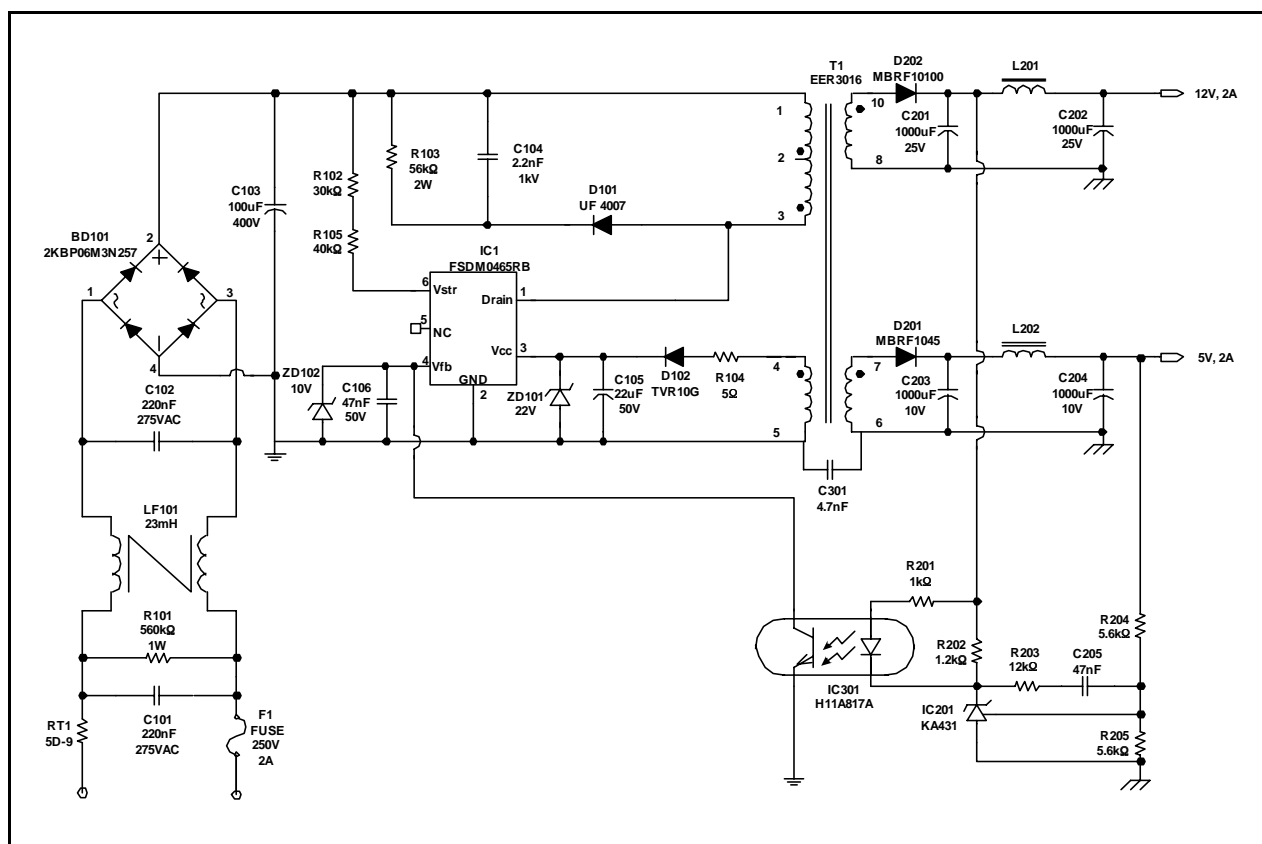

## 2. Transformer Schematic Diagram

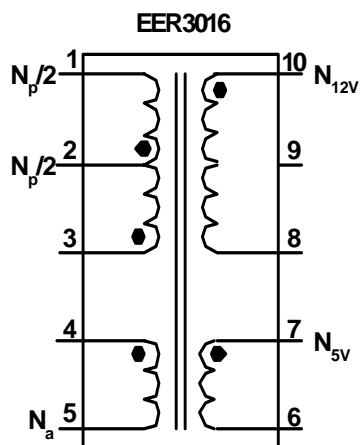

## 3. Winding Specification

No	Pin (s→f)	Wire	Turns	Winding Method
Na	4 → 5	0.2 <sup>φ</sup> × 1	8	Center Winding
Insulation: Polyester Tape t = 0.050mm, 2Layers				
Np/2	2 → 1	0.4 <sup>φ</sup> × 1	18	Solenoid Winding
Insulation: Polyester Tape t = 0.050mm, 2Layers				
N12V	10 → 8	0.3 <sup>φ</sup> × 3	7	Center Winding
Insulation: Polyester Tape t = 0.050mm, 2Layers				
N5V	7 → 6	0.3 <sup>φ</sup> × 3	3	Center Winding
Insulation: Polyester Tape t = 0.050mm, 2Layers				
Np/2	3 → 2	0.4 <sup>φ</sup> × 1	18	Solenoid Winding
Outer Insulation: Polyester Tape t = 0.050mm, 2Layers				

## 4. Electrical Characteristics

	Pin	Specification	Remarks
Inductance	1 - 3	650uH ± 10%	100kHz, 1V
Leakage Inductance	1 - 3	10uH Max	2 <sup>nd</sup> All Short

## 5. Core & Bobbin

Core: EER 3016

Bobbin: EER3016

Ae(mm<sup>2</sup>): 96

## 6.Demo Circuit Part List

Part	Value	Note	Part	Value	Note
<b>Fuse</b>			C301	4.7nF	Polyester Film Cap.
F101	2A/250V				
<b>NTC</b>			<b>Inductor</b>		
RT101	5D-9		L201	5uH	Wire 1.2mm
<b>Resistor</b>			L202	5uH	Wire 1.2mm
R101	560K	1W			
R102	30K	1/4W			
R103	56K	2W			
R104	5	1/4W	<b>Diode</b>		
R105	40K	1/4W	D101	UF4007	
R201	1K	1/4W	D102	TVR10G	
R202	1.2K	1/4W	D201	MBRF1045	
R203	12K	1/4W	D202	MBRF10100	
R204	5.6K	1/4W	ZD101	Zener Diode	22V
R205	5.6K	1/4W	ZD102	Zener Diode	10V
			<b>Bridge Diode</b>		
			BD101	2KBP06M 3N257	Bridge Diode
<b>Capacitor</b>			<b>Line Filter</b>		
C101	220nF/275VAC	Box Capacitor			
C102	220nF/275VAC	Box Capacitor	LF101	23mH	Wire 0.4mm
C103	100uF/400V	Electrolytic Capacitor	<b>IC</b>		
C104	2.2nF/1kV	Ceramic Capacitor	IC101	FSDM0465RB	FPS™(4A,650V)
C105	22uF/50V	Electrolytic Capacitor	IC201	KA431(TL431)	Voltage Reference
C106	47nF/50V	Ceramic Capacitor	IC301	H11A817A	Opto-Coupler
C201	1000uF/25V	Electrolytic Capacitor			
C202	1000uF/25V	Electrolytic Capacitor			
C203	1000uF/10V	Electrolytic Capacitor			
C204	1000uF/10V	Electrolytic Capacitor			
C205	47nF/50V	Ceramic Capacitor			



## 7. Layout

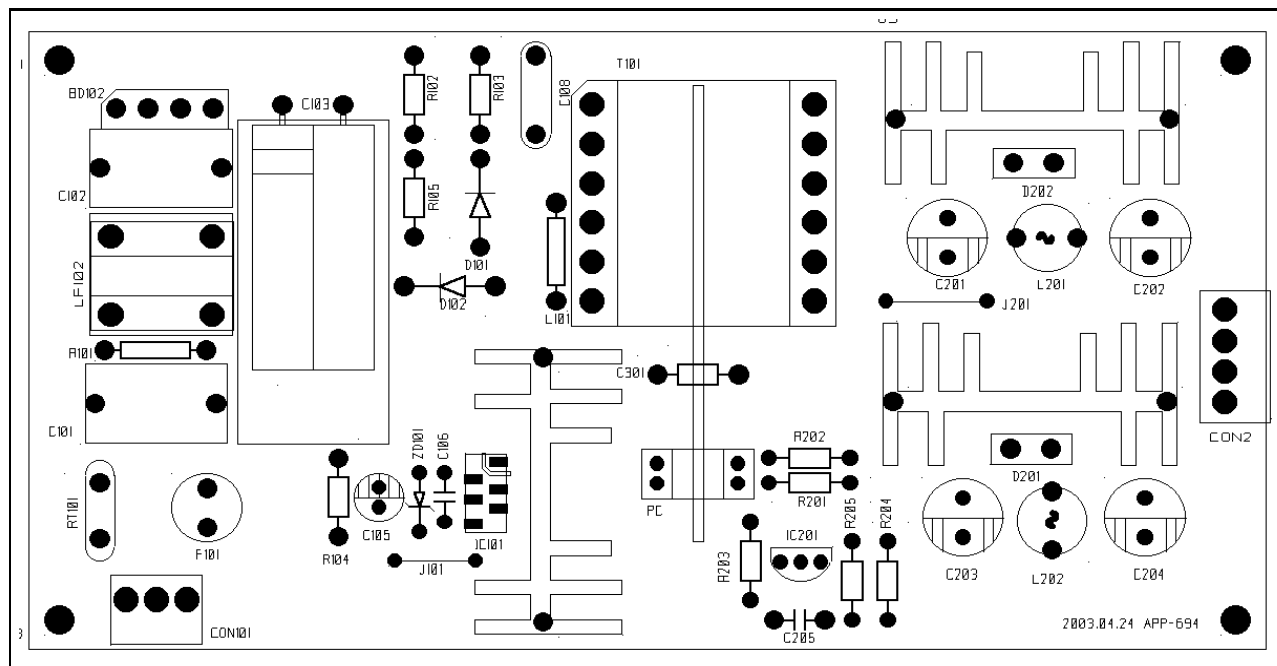

Figure 9. PCB Top Layout Considerations for FSDM0465RB

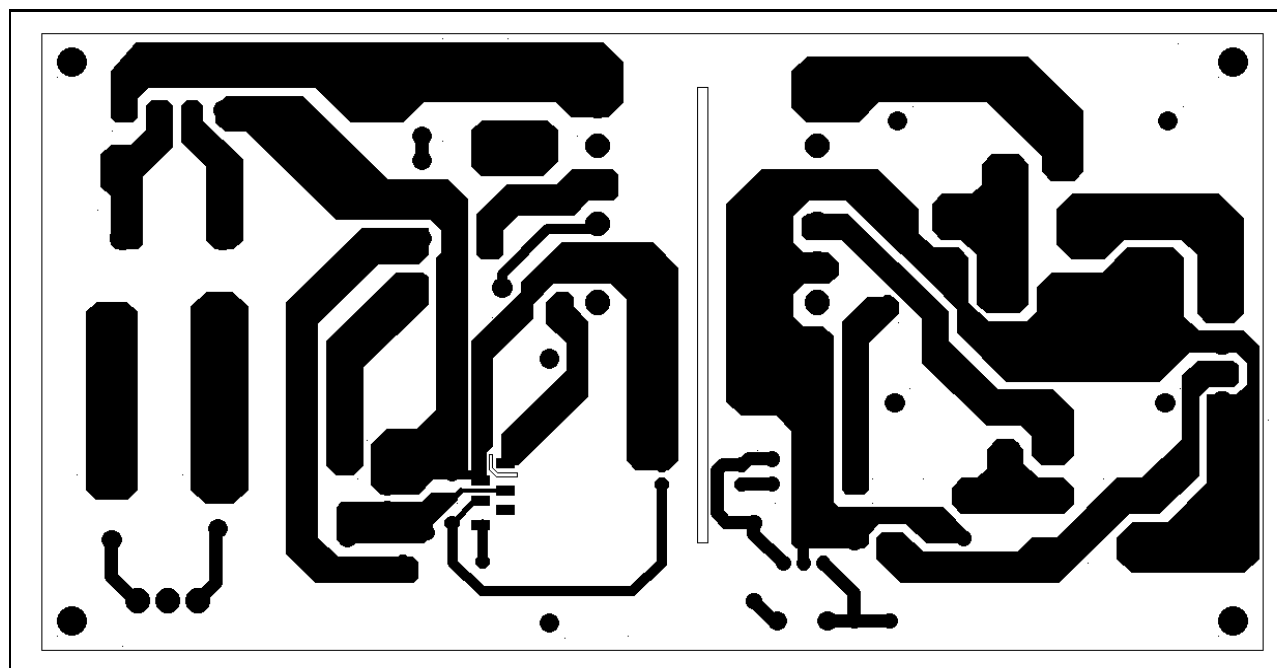

Figure 10. PCB Bottom Layout Considerations for FSDM0465RB



## Ordering Information

Product Number	Package	Marking Code	BVdss	Rds(on) Max.
FSDM0465RBWDTU	TO-220F-6L(Forming)	DM0465R	650V	2.6 $\Omega$

WDTU: Forming Type

### DISCLAIMER

FAIRCHILD SEMICONDUCTOR RESERVES THE RIGHT TO MAKE CHANGES WITHOUT FURTHER NOTICE TO ANY PRODUCTS HEREIN TO IMPROVE RELIABILITY, FUNCTION OR DESIGN. FAIRCHILD DOES NOT ASSUME ANY LIABILITY ARISING OUT OF THE APPLICATION OR USE OF ANY PRODUCT OR CIRCUIT DESCRIBED HEREIN; NEITHER DOES IT CONVEY ANY LICENSE UNDER ITS PATENT RIGHTS, NOR THE RIGHTS OF OTHERS.

### LIFE SUPPORT POLICY

FAIRCHILD'S PRODUCTS ARE NOT AUTHORIZED FOR USE AS CRITICAL COMPONENTS IN LIFE SUPPORT DEVICES OR SYSTEMS WITHOUT THE EXPRESS WRITTEN APPROVAL OF THE PRESIDENT OF FAIRCHILD SEMICONDUCTOR CORPORATION. As used herein:

1. Life support devices or systems are devices or systems which, (a) are intended for surgical implant into the body, or (b) support or sustain life, and (c) whose failure to perform when properly used in accordance with instructions for use provided in the labeling, can be reasonably expected to result in a significant injury of the user.
2. A critical component in any component of a life support device or system whose failure to perform can be reasonably expected to cause the failure of the life support device or system, or to affect its safety or effectiveness.

ON Semiconductor and  are trademarks of Semiconductor Components Industries, LLC dba ON Semiconductor or its subsidiaries in the United States and/or other countries. ON Semiconductor owns the rights to a number of patents, trademarks, copyrights, trade secrets, and other intellectual property. A listing of ON Semiconductor's product/patent coverage may be accessed at [www.onsemi.com/site/pdf/Patent-Marking.pdf](http://www.onsemi.com/site/pdf/Patent-Marking.pdf). ON Semiconductor reserves the right to make changes without further notice to any products herein. ON Semiconductor makes no warranty, representation or guarantee regarding the suitability of its products for any particular purpose, nor does ON Semiconductor assume any liability arising out of the application or use of any product or circuit, and specifically disclaims any and all liability, including without limitation special, consequential or incidental damages. Buyer is responsible for its products and applications using ON Semiconductor products, including compliance with all laws, regulations and safety requirements or standards, regardless of any support or applications information provided by ON Semiconductor. "Typical" parameters which may be provided in ON Semiconductor data sheets and/or specifications can and do vary in different applications and actual performance may vary over time. All operating parameters, including "Typicals" must be validated for each customer application by customer's technical experts. ON Semiconductor does not convey any license under its patent rights nor the rights of others. ON Semiconductor products are not designed, intended, or authorized for use as a critical component in life support systems or any FDA Class 3 medical devices or medical devices with a same or similar classification in a foreign jurisdiction or any devices intended for implantation in the human body. Should Buyer purchase or use ON Semiconductor products for any such unintended or unauthorized application, Buyer shall indemnify and hold ON Semiconductor and its officers, employees, subsidiaries, affiliates, and distributors harmless against all claims, costs, damages, and expenses, and reasonable attorney fees arising out of, directly or indirectly, any claim of personal injury or death associated with such unintended or unauthorized use, even if such claim alleges that ON Semiconductor was negligent regarding the design or manufacture of the part. ON Semiconductor is an Equal Opportunity/Affirmative Action Employer. This literature is subject to all applicable copyright laws and is not for resale in any manner.

## PUBLICATION ORDERING INFORMATION

### LITERATURE FULFILLMENT:

Literature Distribution Center for ON Semiconductor  
19521 E. 32nd Pkwy, Aurora, Colorado 80011 USA  
**Phone:** 303-675-2175 or 800-344-3860 Toll Free USA/Canada  
**Fax:** 303-675-2176 or 800-344-3867 Toll Free USA/Canada  
**Email:** [orderlit@onsemi.com](mailto:orderlit@onsemi.com)

**N. American Technical Support:** 800-282-9855 Toll Free  
USA/Canada  
**Europe, Middle East and Africa Technical Support:**  
Phone: 421 33 790 2910  
**Japan Customer Focus Center**  
Phone: 81-3-5817-1050

**ON Semiconductor Website:** [www.onsemi.com](http://www.onsemi.com)  
**Order Literature:** <http://www.onsemi.com/orderlit>  
For additional information, please contact your local  
Sales Representative

# Mouser Electronics

Authorized Distributor

Click to View Pricing, Inventory, Delivery & Lifecycle Information:

[onsemi:](#)

[FSDM0465RBWDTU](#)