



**ON Semiconductor®**

<http://onsemi.com>

# STK672-400

---

Thick-Film Hybrid IC

## 2-phase Stepping Motor Driver

### Overview

The STK672-400 is a hybrid IC for use as a unipolar, 2-phase stepping motor driver with PWM current control.

### Applications

- Office photocopiers, printers, etc.

### Features

- Entry of external clock is enough to activate the micro step sinusoidal driver.
- The excitation mode of 2, 1-2, W1-2, 2W1-2, or 4W1-2 can be selected with the external pin.
- The 4-phase distributor switching timing can be set to occur either on both rising and falling edge detection or on rising edge detection only with an external pin (MODE3).
- A phase holding function is provided to prevent phase skip during switching of excitation in the course of operation.
- The motor current is set by a voltage divider formed by an external resistor connected to the Vref pin.
- The CLK input pin is provided with an internal noise filtering circuit in addition to a Schmidt circuit to increase the margin for extraneous noise.
- When set low, the ENABLE pin turns off the motor drive current for all phases and retains the phase excitation state.

# STK672-400

## Specifications

### Absolute Maximum Ratings at $T_c = 25^\circ\text{C}$

Parameter	Symbol	Conditions	Ratings	unit
Maximum supply voltage 1	$V_{CC}$ max	No signal	52	V
Maximum supply voltage 2	$V_{DD}$ max	No signal	-0.3 to +7.0	V
Input voltage	$V_{IN}$ max	Logic input pins	-0.3 to +5.8	V
Output current	$I_{OH}$ max	$V_{DD}=5\text{V}$ , $\text{CLOCK} \geq 200\text{Hz}$	2.2	A
Allowable power dissipation	$P_d$ max	With an arbitrarily large heat sink. Per MOSFET	7	W
Operating substrate temperature	$T_c$ max		105	$^\circ\text{C}$
Junction temperature	$T_j$ max		150	$^\circ\text{C}$
Storage temperature	$T_{stg}$		-40 to +125	$^\circ\text{C}$

Stresses exceeding Maximum Ratings may damage the device. Maximum Ratings are stress ratings only. Functional operation above the Recommended Operating Conditions is not implied. Extended exposure to stresses above the Recommended Operating Conditions may affect device reliability.

### Allowable Operating Ranges at $T_a=25^\circ\text{C}$

Parameter	Symbol	Conditions	Ratings	unit
Operating supply voltage 1	$V_{CC}$	With signals applied	10 to 45	V
Operating supply voltage 2	$V_{DD}$	With signals applied	5 $\pm$ 5%	V
Input high voltage	$V_{IH}$		0 to 5.8	V
Output current	$I_{OH}$	$T_c=105^\circ\text{C}$ , $\text{CLOCK} \geq 200\text{Hz}$	2	A
Phase driver withstand voltage	$V_{DSS}$	TR1, 2, 3, 4 $I_D=1\text{mA}$ ( $T_c=25^\circ\text{C}$ )	100min	V

### Electrical Characteristics at $T_c=25^\circ\text{C}$ , $V_{CC}=24\text{V}$ , $V_{DD}=5.0\text{V}$

Parameter	Symbol	Conditions	min	typ	max	unit
$V_{DD}$ supply current	$I_{CCO}$	$V_{DD}=5.0\text{V}$ , $\text{ENABLE}=\text{Low}$ $V_{ref}=2\text{V}$	6	10	15	mA
Output average current	$I_{oave}$	$R/L=3\Omega/3.8\text{mH}$ in each phase	0.51	0.59	0.66	A
FET diode forward voltage	$V_{df}$	$I_f=1\text{A}$		1.2	1.6	V
Output saturation voltage	$V_{sat}$	$R_L=23\Omega$		0.5	0.7	V
Control input pin	Input voltage	$V_{IH}$	Except for the $V_{ref}$ pin	2.5		V
		$V_{IL}$	Except for the $V_{ref}$ pin		0.6	V
	Input current	$I_{il}$	Except for the $V_{ref}$ pin		10	$\mu\text{A}$
$V_{ref}$ pin	Input voltage	$V_I$	Pin 19	2	$V_{DD}$	V
	Input current	$I_{os}$	Pin 19, $V_{DD}$ input		12.5	$\mu\text{A}$
PWM frequency	$f_c$		37.5	50	62.5	kHz
<b>Current Distribution Ratio</b>						
2W1-2	W1-2	1-2	$V_{ref}$ *1	$\theta=7/8$	100	%
2W1-2	W1-2			$\theta=6/8$	93	
2W1-2				$\theta=5/8$	84	
2W1-2	W1-2	1-2		$\theta=4/8$	71	
2W1-2				$\theta=3/8$	55	
2W1-2	W1-2			$\theta=2/8$	40	
2W1-2				$\theta=1/8$	19	
2					100	

Notes: A fixed-voltage power supply must be used.

The value of Item 1 is the design target and not measured.

# STK672-400

## Package Dimensions

unit:mm (typ)

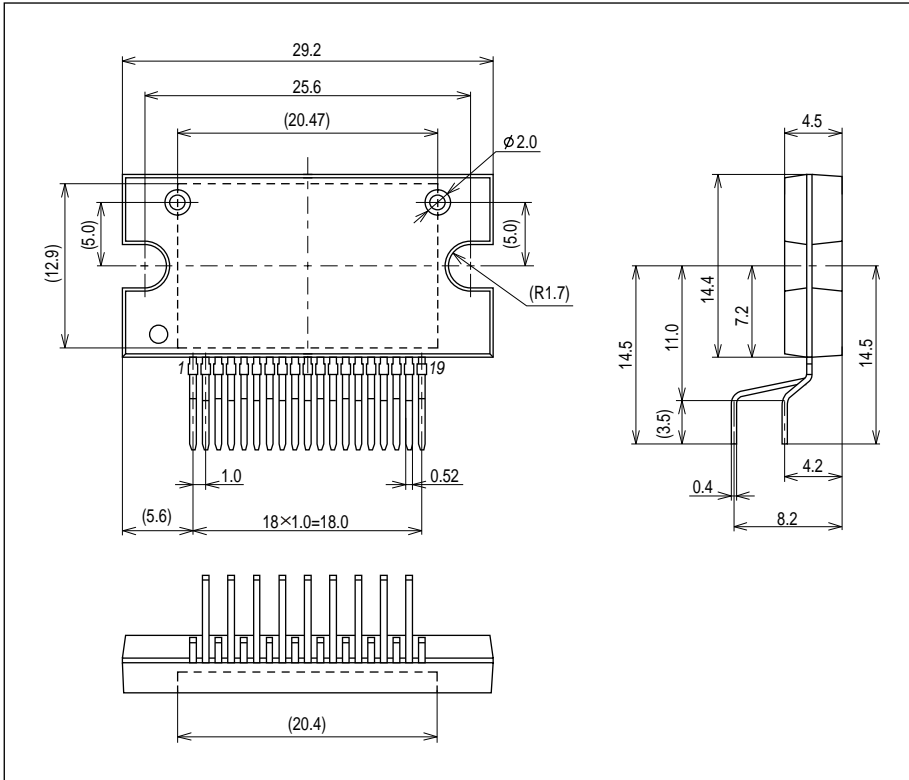

Derating Curve of Motor Current,  $I_{OH}$ , vs. STK672-400 Operating Substrate Temperature,  $T_c$

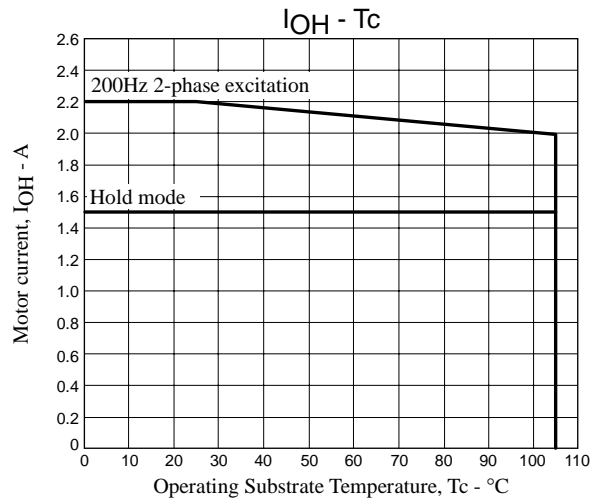

### Notes

- The current range given above represents conditions when output voltage is not in the avalanche state.
- If the output voltage is in the avalanche state, see the allowable avalanche energy for STK672-400 series hybrid ICs given in a separate document.
- The operating substrate temperature,  $T_c$ , given above is measured while the motor is operating. Because  $T_c$  varies depending on the ambient temperature,  $T_a$ , the value of  $I_{OH}$ , and the continuous or intermittent operation of  $I_{OH}$ , always verify this value using an actual set.

Block Diagram

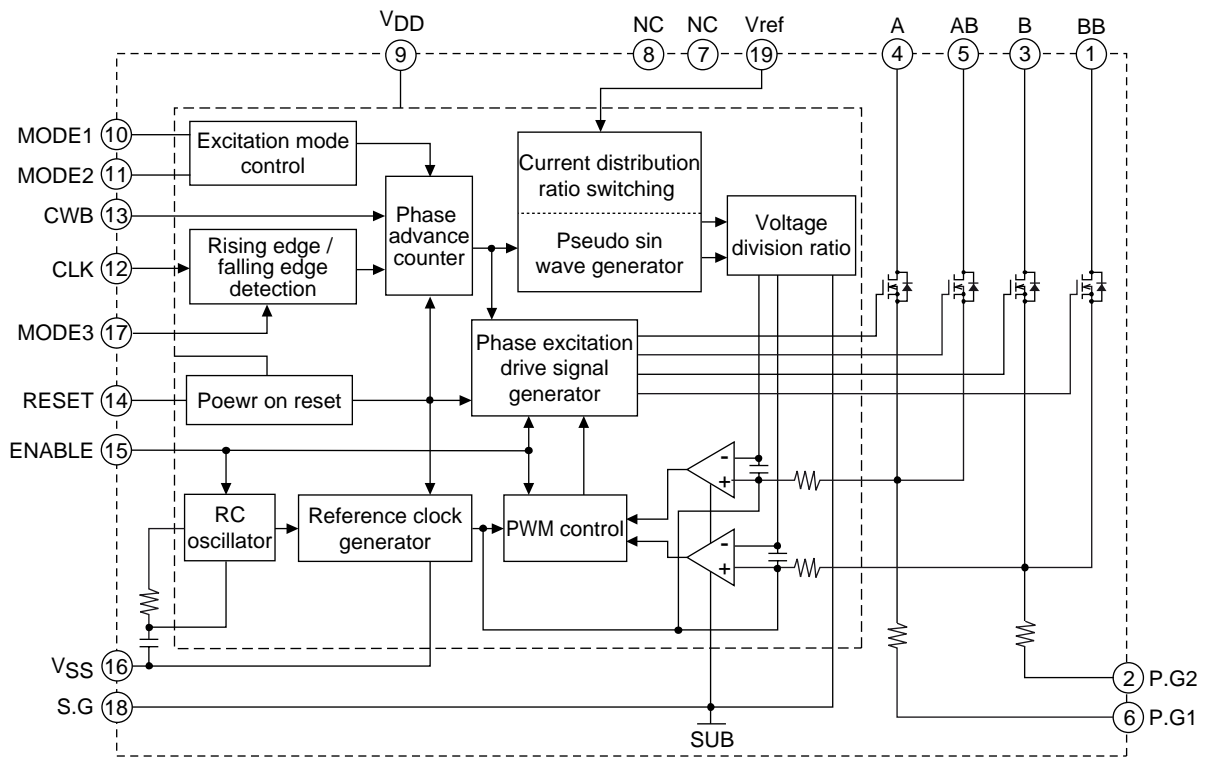

Sample Application Circuit

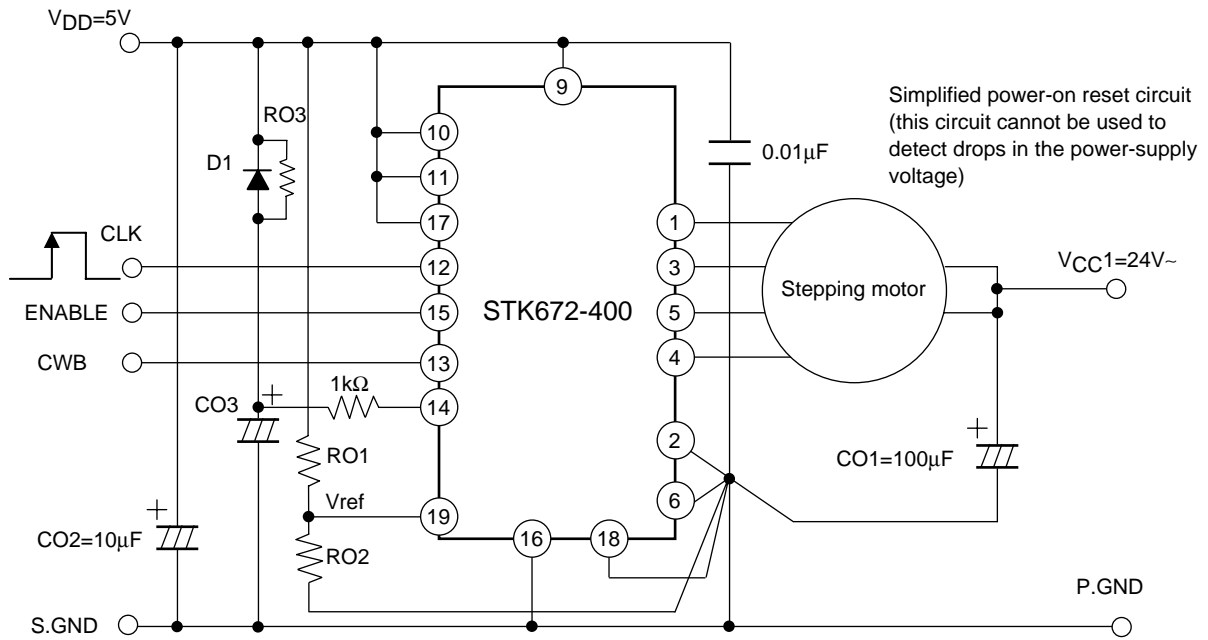

## Precautions

### [Internal MOSFET Destruction]

- The internal MOSFET gate voltage is supplied from the 5V power supply. If the 5V power supply voltage is below its allowable operating voltage range, the resultant insufficient gate drive state may destroy the MOSFET.

### [GND wiring]

- To reduce noise in the 24V system, locate the ground side of CO1 in the circuit above as close as possible to pins 2 and 6 on the hybrid IC. Also, to assure that the current is set accurately, the Vref ground side must be connected to a ground point that is a shared connection between the ground pin (pin 18, S.G) used for the current setting and P.G1 and P.G2.
- If the VSS pin (pin 16) near the driver, the S.G pin (pin 18), the P.G1 pin (pin 2), and the P.G2 pin (pin 6) cannot be connected to a single-point ground, connect the VSS pin to the control system S.GND, and the S.G pin to the P.G1 pin and the P.G2 pin.

### [Input pins]

- The voltage range for the input pins is -0.3 to +5.8V. Design applications so that voltages lower than -0.3V and higher than 5.8V are never applied to the input pin.
- Do not connect any of the NC pins (pins 7, and 8) shown in the internal equivalent circuit block diagram to the circuit pattern on the printed circuit board.
- Connect a resistor (1kΩ) so that discharge energy of capacitor CO2 does not enter the hybrid IC.
- Inputs to pins 10, 11, 12, 13, 14, 15, and 17 are signal whose high level is 2.5V. Both TTL and CMOS inputs are supported.
- Internal pull-up resistors are not provided for the input pins. If this hybrid IC's inputs are controlled by open-collector type circuits, external pull-up resistors must be provided.
- If resistors are connected in series with the inputs, insert capacitors between the inputs and ground to prevent malfunctions due to the hybrid IC's switching noise.
- In the application circuit example, a simple reset circuit is formed by D1, RO3, CO2, and a 1kΩ resistor. This circuit will not create a reset signal if the 5V supply voltage drops briefly. This circuit structure requires the 5V supply voltage to fall below 0.6V to operate.

Connect the hybrid IC directly to V<sub>DD</sub> to use the hybrid IC's power on reset function.

- A power on reset operation must be applied when the 5V power supply level is first applied.

### [Vref Current Setting]

- To reduce the influence of input impedance 200kΩ input current of the terminal Vref, RO1 recommends about 1kΩ.
- We recommend using the following circuit to temporarily reduce the motor current.
- Although the driver provides a constant current control function, it does not have an overcurrent protection function to assure that the maximum output current, I<sub>OH max</sub>, is not exceeded. If Vref is set by mistake to a voltage that such that I<sub>OH max</sub> is exceeded, the driver will draw excessive current and the device will be destroyed.
- If the Vref pin (pin 19) is left open, the Vref voltage will be set to about 2.5V. With the STK672-400, the motor current will then be about 1.8A. With the STK672-410, the motor current will be about 3.2A. These current settings are close to I<sub>OH max</sub>.

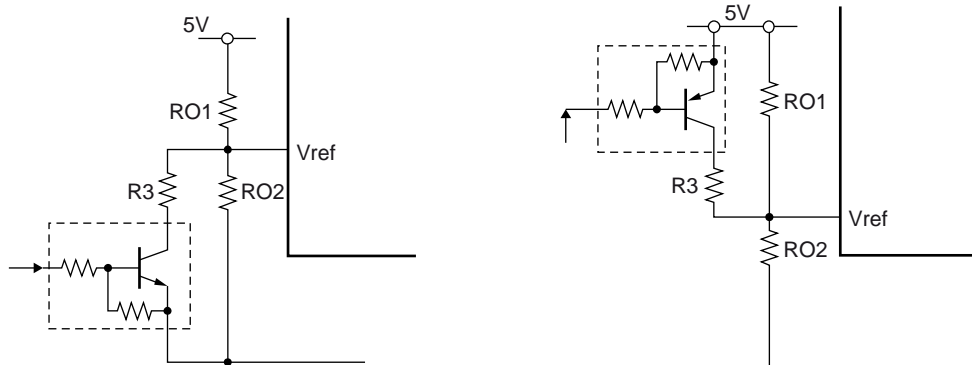

# STK672-400

[Setting the motor current]

The motor current is set by the hybrid IC's pin 19V, Vref. The formula shows below gives the relationship between IOH and Vref.

$$V_{ref} = V_{DD} - (I_{OH} \times R_s \times K) \dots\dots\dots (1)$$

K: 9.33 (voltage divider ratio)

Rs: 0.152Ω (hybrid IC internal current detection resistance: precision = ±3%)

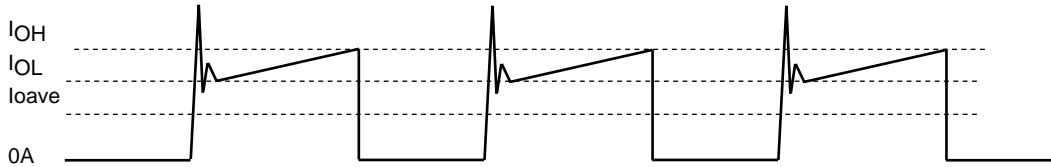

Model of the Motor Phase Current Flowing into the Hybrid IC

### Function Table

	M2	0	0	1	1	Phase switching clock edge timing
	M1	0	1	0	1	
M3		0	1	0	1	
	1	2 phase excitation	1-2 phase excitation	W1-2 phase excitation	2W1-2 phase excitation	CLK rising edge
	0	1-2 phase excitation	W1-2 phase excitation	2W1-2 phase excitation	4W1-2 phase excitation	Both CLK edges

### CWB pin

	Forward	Reverse
CWB	0	1

### ENABLE and RESET pins

ENABLE	Motor current cut: Low
RESET	Active Low

Timing Charts

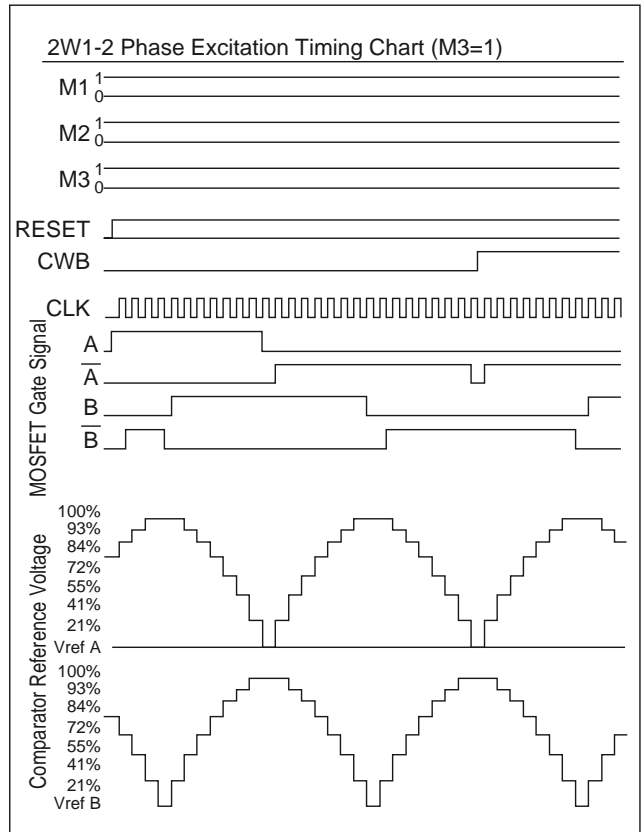
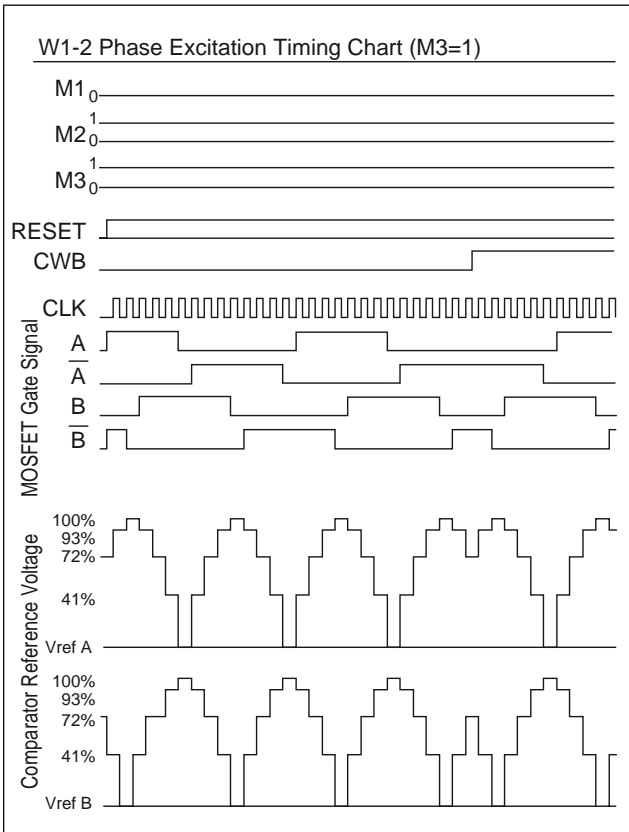
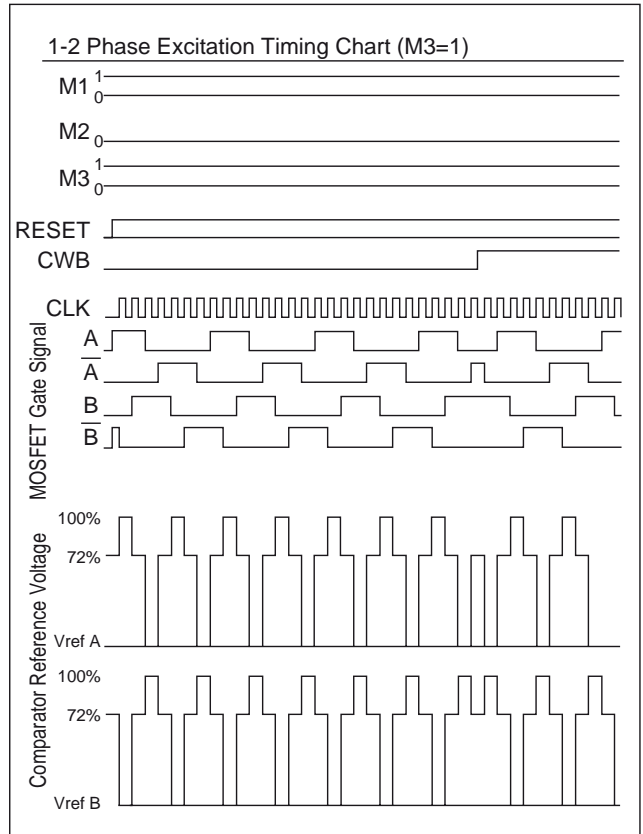
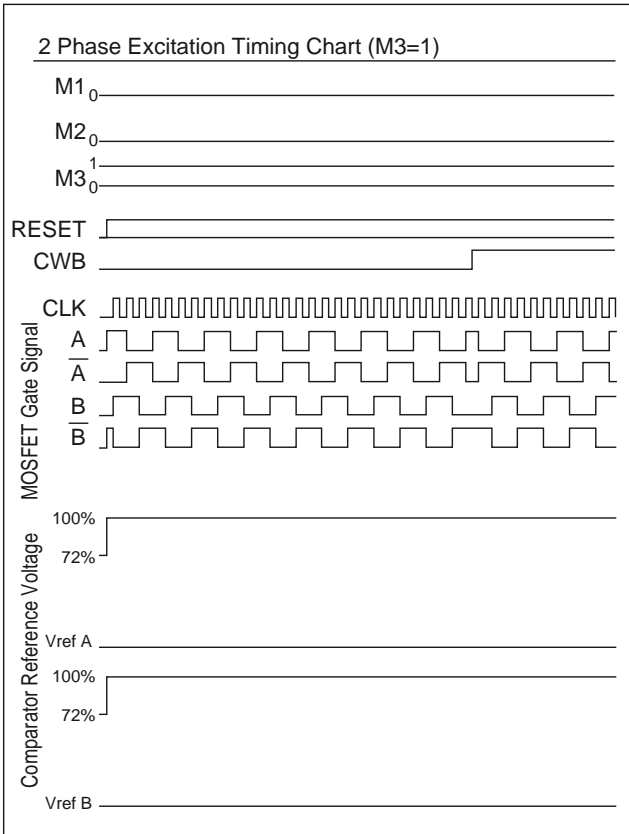

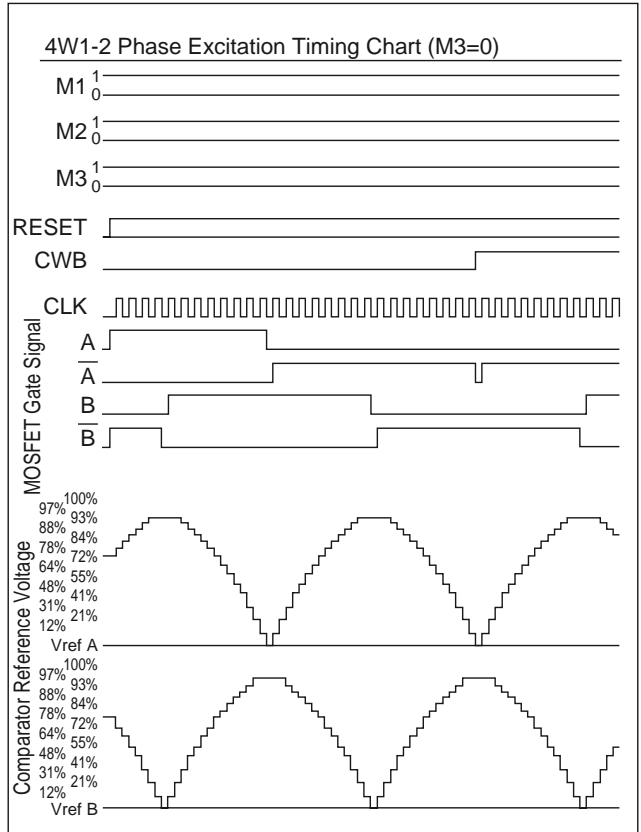
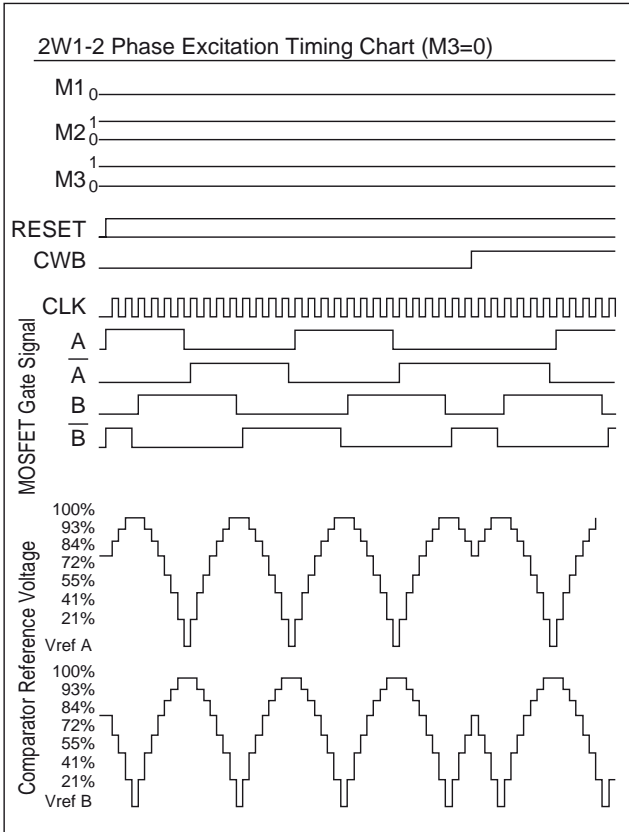
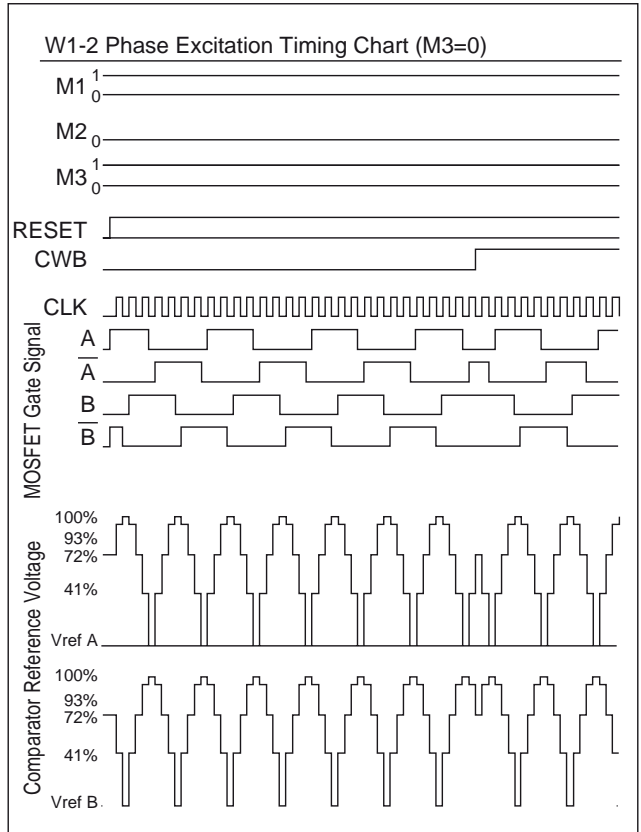
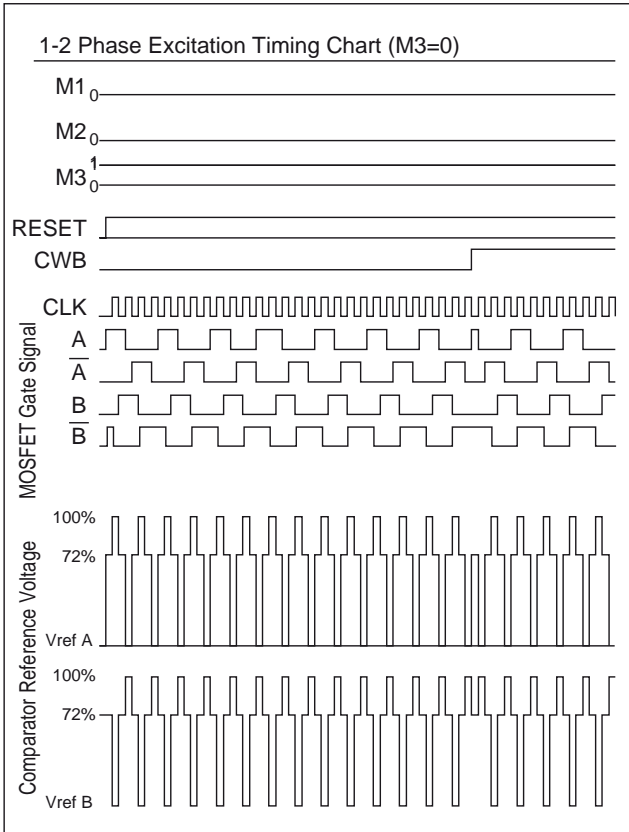



**Usage Notes**

1. Input pins and functional overview

[Input pins]

Hybrid IC pin No.	Symbol	Function	Pin type
19	Vref	Current setting	Input impedance: 200kΩ (typical)
10, 11, 13	MODE1, MODE2, MODE3	Excitation mode setting	TTL level Schmitt input
12	CLK	Phase switching clock (speed command)	Same as the above
13	CWB	Motor direction setting	Same as the above
14	RESET	System reset	Same as the above
15	ENABLE	Motor current off	Same as the above

2. Input signal functions

[CLK (Phase switching clock)]

- (1) Input frequency: DC to 50kHz
- (2) Minimum pulse width: 10μs
- (3) Pulse width duty: 40 to 60%
- (4) Pin circuit type: TTL level Schmitt trigger input
- (5) A multi-stage noise exclusion circuit is included.
- (6) Function
  - M3:1  
When M3 is 1: The excitation phase is advanced one step on each CLK signal rising edge.
  - M3:0  
When M3 is 0: The excitation phase is advanced one step alternately on each CLK signal rising or falling edge.

• Timing chart

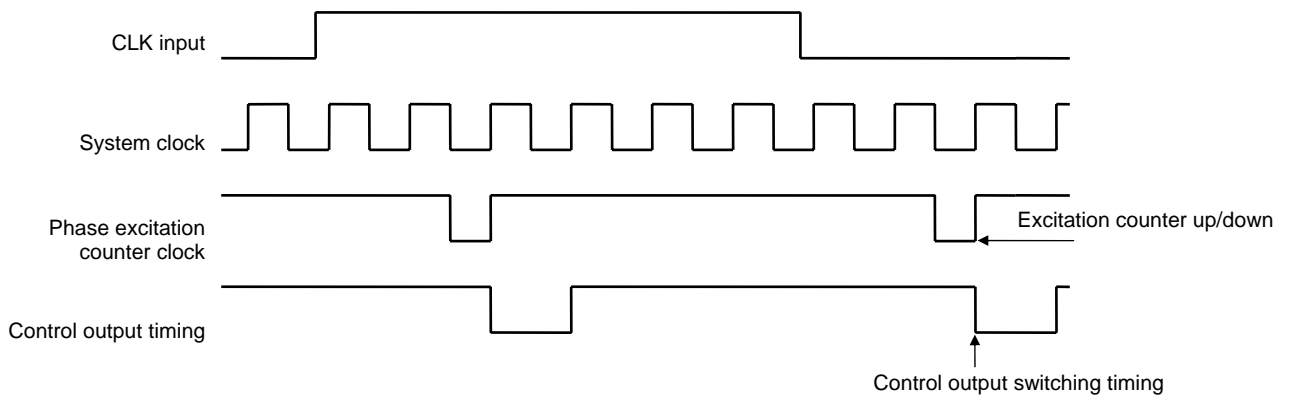

[CWB (Motor direction setting)]

- (1) Pin circuit type: TTL level Schmitt trigger input
- (2) Function
  - When CWB = 0: The motor turns in the clockwise direction
  - When CWB = 1: The motor turns in the counterclockwise direction
- (3) Note: The value of the CWB input must not be changed in the period from 7μs before a CLK input rising or falling edge until 7μs after that edge.

[ENABLE (Forces the excitation drive outputs A, AB, B, and BB to the off state and selects the hybrid IC's internal state to be operating or hold)]

- (1) Pin circuit type: TTL level Schmitt trigger input
- (2) Function
  - a) When ENABLE is 1: Normal operating state
  - b) When ENABLE is 0: The motor current is turned off and the excitation drive output is turned off forcibly. At this time, the hybrid IC's system clock is stopped and the hybrid IC is not influenced by changes to any input pins other than the reset input.

[MODE1, MODE2, and MODE3 (Excitation mode and timing mode selection)]

- (1) Pin circuit type: TTL level Schmitt trigger input
- (2) Excitation mode selection (See the application circuit example page for details on excitation mode selection.)
- (3) Valid mode setting timing: Do not change the mode within the  $\pm 7\mu\text{s}$  period around any rising or falling edge on the CLK input signal.

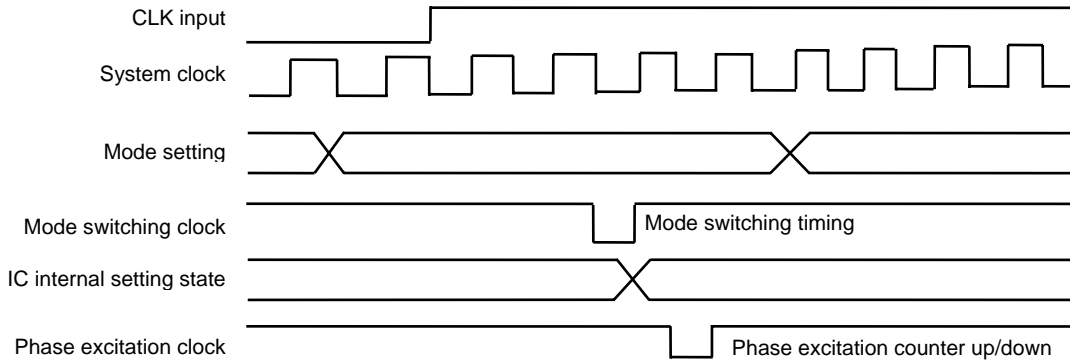

Mode Setting Acquisition Timing

[RESET (Whole system reset)]

- (1) Pin circuit type: TTL level Schmitt trigger input
- (2) Function: The reset signal to this hybrid IC's internal sequencer can be selected to be either the hybrid IC internal power-on reset function or an external signal. To operate the hybrid IC internal sequencer from the hybrid IC internal power-on reset signal, connect the hybrid IC's pin 14 to  $V_{DD}$ . The hybrid IC internal reset signal is generated with a timing such that it is output to internal circuits when  $V_{DD}$  is in the range 2.9 to 3.9V. Alternatively, if an external signal is used as the reset signal, it must have the timing relative to the rise of the  $V_{DD}$  voltage shown in the figure below. Note that the reset pulse must have a pulse width of at least  $10\mu\text{s}$ .

- External reset and power supply application sequence

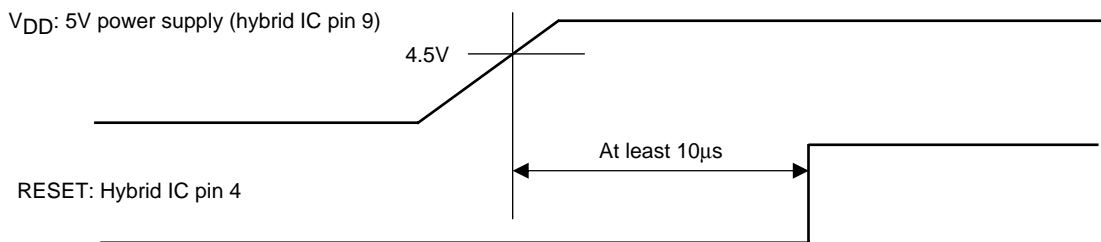

## STK672-400

[Vref (Sets the current that is used as the reference for setting the output current)]

(1) Pin circuit type: Analog input (differential amplifier). Input resistance:  $200\text{k}\Omega$

(2) Function: The input voltage must be in the voltage range from the control system power supply  $V_{DD}$  to 2V. Note that there is a resistance component ( $200\text{k}\Omega$ , typical) in this hybrid IC's input and that therefore an input current occurs.

If the Vref voltage structure is formed as a resistor voltage divider, that circuit must be designed to take that input current into account. The input current is  $12.5\mu\text{A}$  (typical). Note that this is the current when Vref is 5V. The input current falls according to the formula shown below when the Vref voltage is below that level.

$$I_{os} = V_{ref} / (200\text{k} + 200\text{k}) \text{ ----- (1)}$$

- Input circuit structure

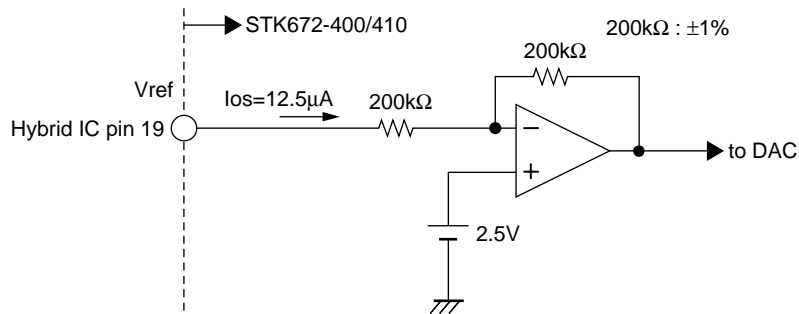

3. Calculating STK672-400 HIC Internal Power Loss

HIC internal loss calculation of STK672-400

The internal average power loss in the excitation modes of STK672-400 is calculated as follows:

[Excitation modes]

2 phase excitation mode

$$2PdAV = (V_{sat}+V_{df}) \times 0.5 \times \text{CLOCK} \times I_{OH} \times t_2 + 0.5 \times \text{CLOCK} \times I_{OH} \times (V_{sat} \times t_1 + V_{df} \times t_3) \text{ ----- (3-1)}$$

1-2 phase excitation mode

$$1-2PdAV = (V_{sat}+V_{df}) \times 0.25 \times \text{CLOCK} \times I_{OH} \times t_2 + 0.25 \times \text{CLOCK} \times I_{OH} \times (V_{sat} \times t_1 + V_{df} \times t_3) \text{ ----- (3-2)}$$

W1-2 phase excitation mode

$$W1-2PdAV = 0.64 [(V_{sat}+V_{df}) \times 0.25 \times \text{CLOCK} \times I_{OH} \times t_2 + 0.25 \times \text{CLOCK} \times I_{OH} \times (V_{sat} \times t_1 + V_{df} \times t_3)] \text{ ----- (3-3)}$$

2W1-2 phase excitation mode

$$2W1-2PdAV = 0.64 [(V_{sat}+V_{df}) \times 0.0625 \times \text{CLOCK} \times I_{OH} \times t_2 + 0.0625 \times \text{CLOCK} \times I_{OH} \times (V_{sat} \times t_1 + V_{df} \times t_3)] \text{ ----- (3-4)}$$

4W1-2 phase excitation mode

$$4W1-2PdAV = 0.64 [(V_{sat}+V_{df}) \times 0.0625 \times \text{CLOCK} \times I_{OH} \times t_2 + 0.0625 \times \text{CLOCK} \times I_{OH} \times (V_{sat} \times t_1 + V_{df} \times t_3)] \text{ ----- (3-5)}$$

At motor hold

$$\text{Hold PdAV} = (V_{sat}+V_{df}) \times I_{OH} \text{----- (3-6)}$$

Note: 2-phase 100% conductance is assumed in Equation (3-6).

V<sub>sat</sub>: Synthetic voltage of Ron voltage drop + Synthetic voltage of current detection resistance

V<sub>df</sub>: Synthetic voltage of FET body diode V<sub>df</sub> + Synthetic voltage of current detection resistance

CLOCK: Input clock CLK (reference frequency before splitting into four phases)

t<sub>1</sub>, t<sub>2</sub>, and t<sub>3</sub> are waveforms shown in the following figure:

t<sub>1</sub>: Time till the winding current reaches the set value (I<sub>OH</sub>).

t<sub>2</sub>: Time for the constant-current control (PWM) region

t<sub>3</sub>: Time from the phase signal OFF up to regenerative consumption of the counter electromotive force

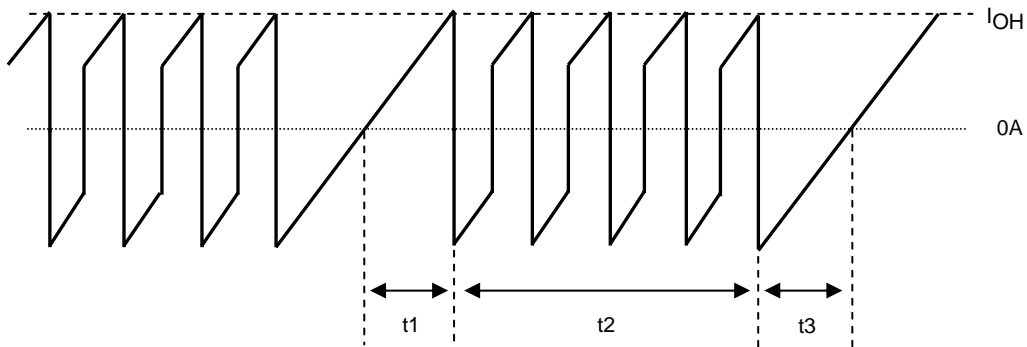

Motor COM Current Waveform Model

$$t_1 = (-L/(R+0.42)) \ln (1 - ((R+0.42)/V_{CC1}) \times I_{OH}) \text{ ----- (3-7)}$$

$$t_3 = (-L/R) \ln ((V_{CC1}+0.9)/(I_{OH} \times R + V_{CC1}+0.9)) \text{ ----- (3-8)}$$

V<sub>CC1</sub>: Motor supply voltage (V)

L: Motor inductance (H)

R: Motor winding resistance (Ω)

I<sub>OH</sub>: Motor set output current crest value (A)

## STK672-400

---

Phase signal ON time T and constant-current control time t2 in excitation modes

- |   |   |
|---|---|
| (1) 2 phase excitation mode                         | $t2 = (2 \div \text{CLOCK}) - (t1 + t3)$ .....(3-9) |
| (2) 1-2 phase excitation mode                       | $t2 = (3 \div \text{CLOCK}) - t1$ .....(3-10)       |
| (3) W1-2 mode                                       | $t2 = (7 \div \text{CLOCK}) - t1$ .....(3-11)       |
| (4) 2W1-2 phase excitation (4W1-2 phase excitation) | $t2 = (15 \div \text{CLOCK}) - t1$ .....(3-12)      |

Enter the value of Vsat and Vdf from Vsat vs IOH and Vdf vs IOH graphs for the set current value of IOH. Compare the HIC average power loss thus determined with the ΔTc vs Pd graph to determine whether the heat sink is necessary. See the section on STK672-400 thermal design section later in this document for details on heat sink design. The value HIC for the average power loss PdAV is the loss when the device is not in the avalanche state. To add the avalanche state loss, add the STK672-400 avalanche energy allowable value from equation (2) to the PdAV value above. When the fin is not used, the HIC substrate temperature Tc changes because of the effect of air convection, etc. Be sure to check temperature rise with the set.

[Calculating PAVL, the average power loss in the avalanche state]

The average power loss in the avalanche state, PAVL, is given by formula (4-2), which is the expression for the loss, PAVL, in the avalanche state during constant-current chopping operation multiplied by the chopping frequency.

$$\text{PAVL} = \text{VDSS} \times \text{IAVL} \times 0.5 \times \text{tAVL} \times \text{fc} \dots\dots\dots (4-2)$$

fc: Hz (Use the maximum PWM frequency for the STK672-400 series.)

The values for VDSS, IAVL, and tAVL must be observed with an oscilloscope in an actual operating circuit based on the STK672-400 series device, and those values must then be substituted into these equations.

The PAVL added differs for the different excitation modes: for modes other than 2 phase excitation, multiply PAVL by the following constant and then add to the hybrid IC internal average power loss.

$$\text{For 1-2 phase excitation and higher modes: } \text{PAVL}(1) = 0.7 \times \text{PAVL} \dots\dots\dots (3-13)$$

$$\text{For 2 phase excitation mode and motor hold mode: } \text{PAVL}(1) = 1 \times \text{PAVL} \dots\dots\dots (3-14)$$

# STK672-400

STK672-400 Output saturation voltage,  $V_{sat}$  - Output current,  $I_{OH}$

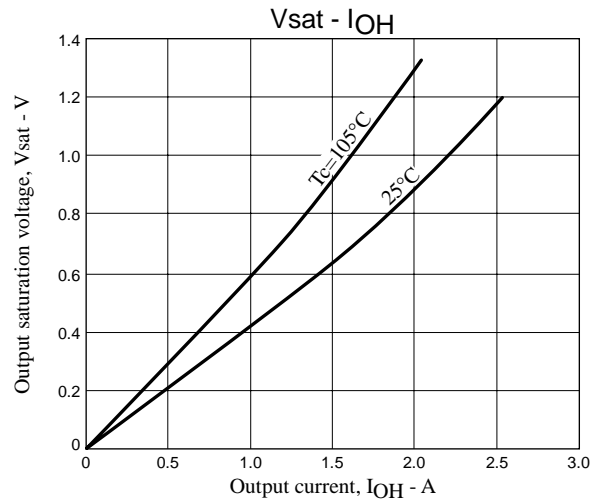

STK672-400 Forward voltage,  $V_{df}$  - Output current,  $I_{OH}$

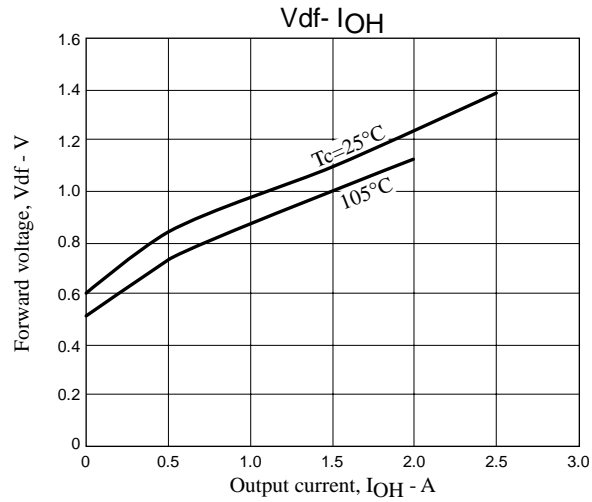

Substrate temperature rise,  $\Delta T_c$  (no heat sink) - Internal average power dissipation,  $P_{dAV}$

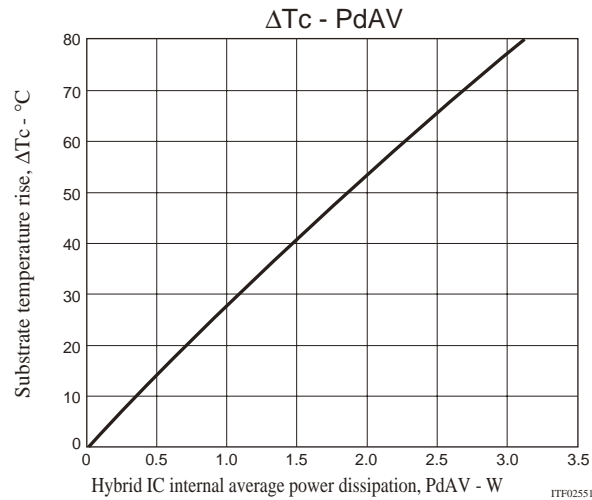

4. STK672-400 Allowable Avalanche Energy Value

(1) Allowable Range in Avalanche Mode

When driving a 2-phase stepping motor with constant current chopping using an STK672-400 hybrid IC, the waveforms shown in Figure 1 below result for the output current,  $I_D$ , and voltage,  $V_{DS}$ .

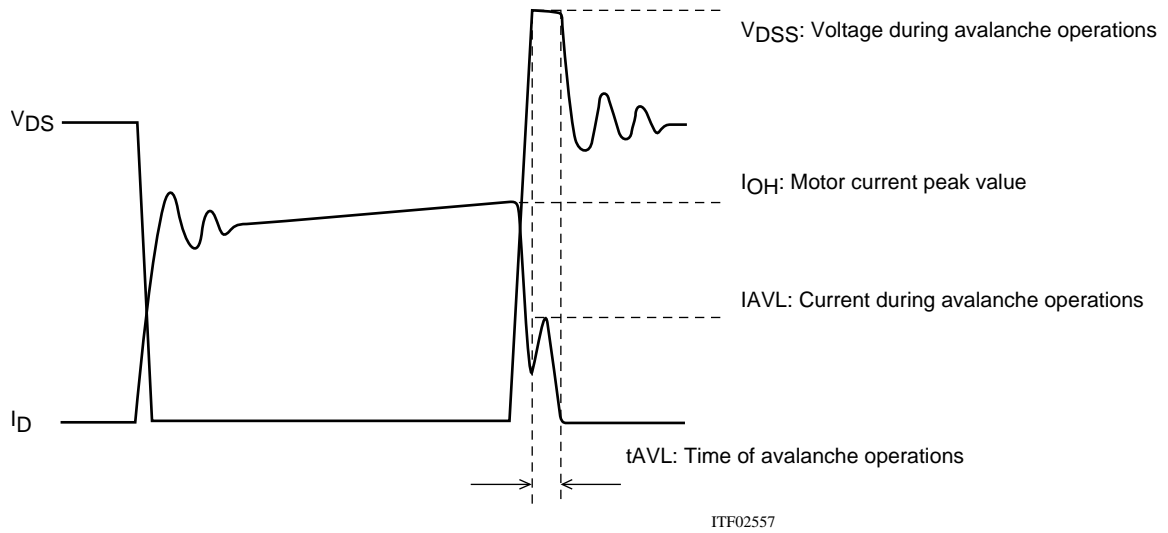

Figure 1 Output Current,  $I_D$ , and Voltage,  $V_{DS}$ , Waveforms 1 of the STK672-400 Series when Driving a 2-Phase Stepping Motor with Constant Current Chopping

When operations of the MOSFET built into STK672-400 Series ICs is turned off for constant current chopping, the  $I_D$  signal falls like the waveform shown in the figure above. At this time, the output voltage,  $V_{DS}$ , suddenly rises due to electromagnetic induction generated by the motor coil.

In the case of voltage that rises suddenly, voltage is restricted by the MOSFET  $V_{DSS}$ . Voltage restriction by  $V_{DSS}$  results in a MOSFET avalanche. During avalanche operations,  $I_D$  flows and the instantaneous energy at this time,  $E_{AVL1}$ , is represented by Equation (4-1).

$$E_{AVL1} = V_{DSS} \times I_{AVL} \times 0.5 \times t_{AVL} \text{ ----- (4-1)}$$

$V_{DSS}$ : V units,  $I_{AVL}$ : A units,  $t_{AVL}$ : sec units

The coefficient 0.5 in Equation (4-1) is a constant required to convert the  $I_{AVL}$  triangle wave to a square wave.

During STK672-400 Series operations, the waveforms in the figure above repeat due to the constant current chopping operation. The allowable avalanche energy,  $E_{AVL}$ , is therefore represented by Equation (4-2) used to find the average power loss,  $P_{AVL}$ , during avalanche mode multiplied by the chopping frequency in Equation (4-1).

$$P_{AVL} = V_{DSS} \times I_{AVL} \times 0.5 \times t_{AVL} \times f_c \text{ ----- (4-2)}$$

$f_c$ : Hz units ( $f_c$  is set to the PWM frequency of 62.5kHz.)

For  $V_{DSS}$ ,  $I_{AVL}$ , and  $t_{AVL}$ , be sure to actually operate the STK672-400 Series and substitute values when operations are observed using an oscilloscope.

Ex. If  $V_{DSS}=110V$ ,  $I_{AVL}=0.8A$ ,  $t_{AVL}=0.2\mu s$  when using a STK672-400 driver, the result is:

$$P_{AVL} = 110 \times 0.8 \times 0.5 \times 0.2 \times 10^{-6} \times 62.5 \times 10^3 = 0.55W$$

$V_{DSS}=110V$  is a value actually measured using an oscilloscope.

The allowable loss range for the allowable avalanche energy value,  $P_{AVL}$ , is shown in the graph in Figure 3. When examining the avalanche energy, be sure to actually drive a motor and observe the  $I_D$ ,  $V_{DS}$ , and  $t_{AVL}$  waveforms during operation, and then check that the result of calculating Equation (4-2) falls within the allowable range for avalanche operations.

(2)  $I_D$  and  $V_{DS}$  Operating Waveforms in Non-avalanche Mode

Although the waveforms during avalanche mode are given in Figure 1, sometimes an avalanche does not result during actual operations.

Factors causing avalanche are listed below.

- Poor coupling of the motor's phase coils (electromagnetic coupling of A phase and AB phase, B phase and BB phase).
- Increase in the lead inductance of the harness caused by the circuit pattern of the P.C. board and motor.
- Increases in  $V_{DSS}$ ,  $t_{AVL}$ , and  $I_{AVL}$  in Figure 1 due to an increase in the supply voltage from 24V to 36V.

If the factors above are negligible, the waveforms shown in Figure 1 become waveforms without avalanche as shown in Figure 2.

Under operations shown in Figure 2, avalanche does not occur and there is no need to consider the allowable loss range of  $PAVL$  shown in Figure 3.

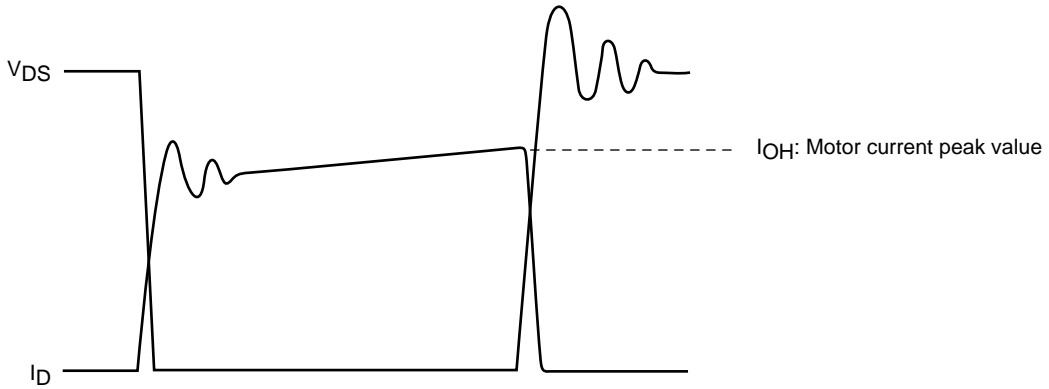

ITF02558

Figure 2 Output Current,  $I_D$ , and Voltage,  $V_{DS}$ , Waveforms 2 of the STK672-400 when Driving a 2-Phase Stepping Motor with Constant Current Chopping

Figure 3 Allowable Loss Range,  $PAVL-I_{OH}$  During STK672-400 Avalanche Operations

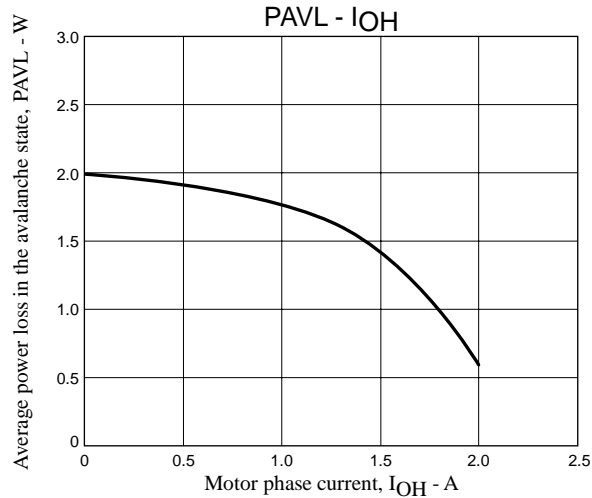

Note:

The operating conditions given above represent a loss when driving a 2-phase stepping motor with constant current chopping.

Because it is possible to apply 2W or more at  $I_{OH}=0A$ , be sure to avoid using the MOSFET body diode that is used to drive the motor as a zener diode.

Consider using these devices in the usage ranges for an operating substrate temperature  $T_c$  of 105°C.



5. STK672-400 Thermal design

[Operating range in which a heat sink is not used]

Use of a heat sink to lower the operating substrate temperature of the HIC (Hybrid IC) is effective in increasing the quality of the HIC.

The size of heat sink for the HIC varies depending on the magnitude of the average power loss, PdAV, within the HIC. The value of PdAV increases as the output current increases. To calculate PdAV, refer to “Calculating Internal HIC Loss for the STK672-400” in the specification document.

Calculate the internal HIC loss, PdAV, assuming repeat operation such as shown in Figure 1 below, since conduction during motor rotation and off time both exist during actual motor operations.

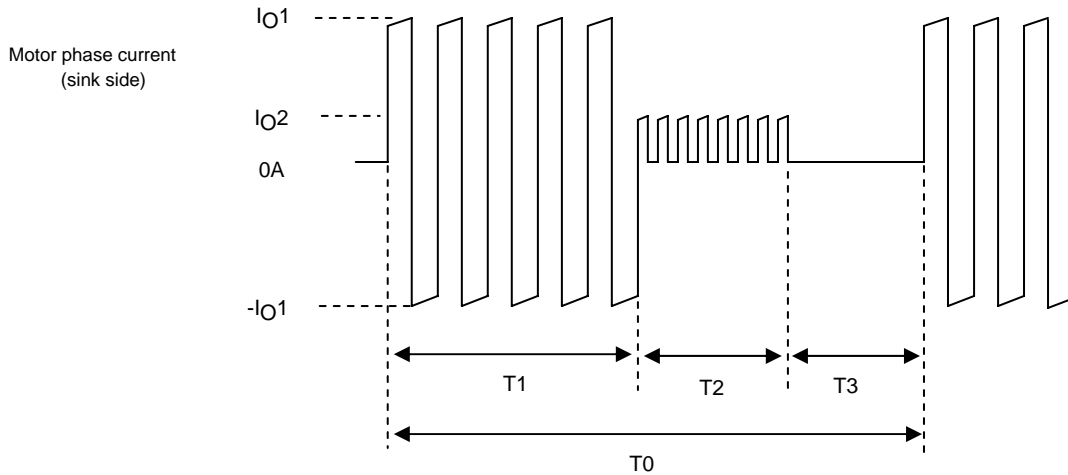

Figure 1 Motor Current Timing

T1: Motor rotation operation time

T2: Motor hold operation time

T3: Motor current off time

T2 may be reduced, depending on the application.

T0: Single repeated motor operating cycle

IO1 and IO2: Motor current peak values

Due to the structure of motor windings, the phase current is a positive and negative current with a pulse form.

Note that figure 1 presents the concepts here, and that the on/off duty of the actual signals will differ.

The hybrid IC internal average power dissipation PdAV can be calculated from the following formula.

$$PdAV = (T1 \times P1 + T2 \times P2 + T3 \times 0) \div T0 \text{ ----- (I)}$$

(Here, P1 is the PdAV for IO1 and P2 is the PdAV for IO2)

If the value calculated using Equation (I) is 1.5W or less, and the ambient temperature, Ta, is 60°C or less, there is no need to attach a heat sink. Refer to Figure 2 for operating substrate temperature data when no heat sink is used.

[Operating range in which a heat sink is used]

Although a heat sink is attached to lower Tc if PdAV increases, the resulting size can be found using the value of θc-a in Equation (II) below and the graph depicted in Figure 3.

$$\theta_{c-a} = (Tc \text{ max} - Ta) \div PdAV \text{ ----- (II)}$$

Tc max: Maximum operating substrate temperature = 105°C

Ta: HIC ambient temperature

Although a heat sink can be designed based on equations (I) and (II) above, be sure to mount the HIC in a set and confirm that the substrate temperature, Tc, is 105°C or less.

The average HIC power loss, PdAV, described above represents the power loss when there is no avalanche operation.

To add the loss during avalanche operations, be sure to add Equation (4-2), “Allowable STK672-400 Avalanche Energy Value”, to PdAV.

Figure 2 Substrate temperature rise,  $\Delta T_c$  - Internal average power dissipation, PdAV

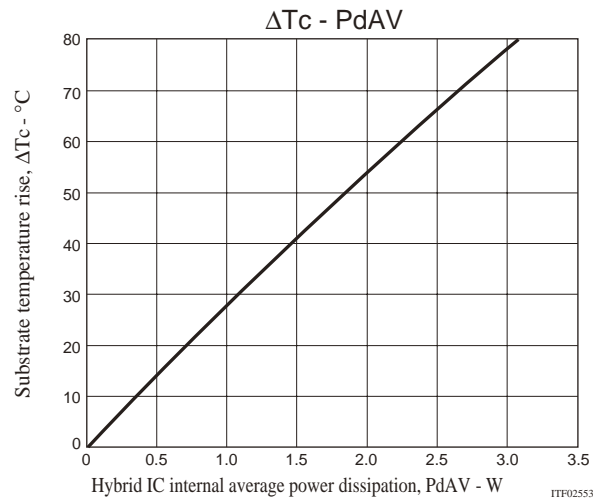
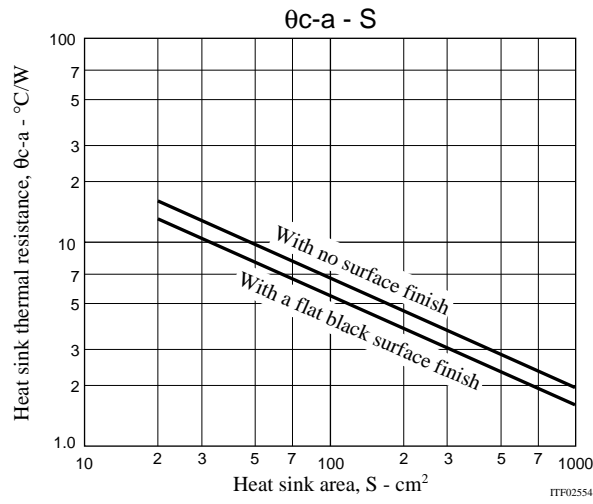

Figure 3 Heat sink area (thickness: 2mm) -  $\theta_{c-a}$



## STK672-400

### 6. STK672-400 and 410 Ambient Temperature $T_a$ Package Power Loss PdPK Derating Curve

The package power loss PdPK is the internal average power loss PdAV that is allowed without a heat sink. The figure below shows the power loss PdPK that is allowable as the ambient temperature  $T_a$  changes. At  $T_a=25^\circ\text{C}$  a power loss of 3.1W is allowable, and at  $T_a=60^\circ\text{C}$ , 1.75W is allowable.

STK672-400 and 410 package power loss PdPK (no heat sink) - Ambient temperature  $T_a$

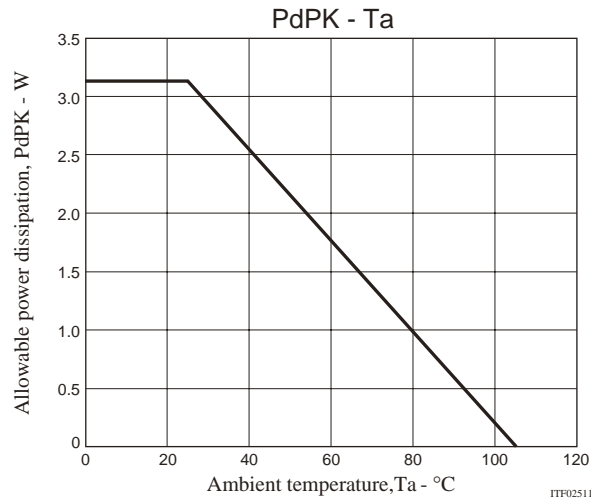

ON Semiconductor and the ON logo are registered trademarks of Semiconductor Components Industries, LLC (SCILLC). SCILLC owns the rights to a number of patents, trademarks, copyrights, trade secrets, and other intellectual property. A listing of SCILLC's product/patent coverage may be accessed at [www.onsemi.com/site/pdf/Patent-Marking.pdf](http://www.onsemi.com/site/pdf/Patent-Marking.pdf). SCILLC reserves the right to make changes without further notice to any products herein. SCILLC makes no warranty, representation or guarantee regarding the suitability of its products for any particular purpose, nor does SCILLC assume any liability arising out of the application or use of any product or circuit, and specifically disclaims any and all liability, including without limitation special, consequential or incidental damages. "Typical" parameters which may be provided in SCILLC data sheets and/or specifications can and do vary in different applications and actual performance may vary over time. All operating parameters, including "Typicals" must be validated for each customer application by customer's technical experts. SCILLC does not convey any license under its patent rights nor the rights of others. SCILLC products are not designed, intended, or authorized for use as components in systems intended for surgical implant into the body, or other applications intended to support or sustain life, or for any other application in which the failure of the SCILLC product could create a situation where personal injury or death may occur. Should Buyer purchase or use SCILLC products for any such unintended or unauthorized application, Buyer shall indemnify and hold SCILLC and its officers, employees, subsidiaries, affiliates, and distributors harmless against all claims, costs, damages, and expenses, and reasonable attorney fees arising out of, directly or indirectly, any claim of personal injury or death associated with such unintended or unauthorized use, even if such claim alleges that SCILLC was negligent regarding the design or manufacture of the part. SCILLC is an Equal Opportunity/Affirmative Action Employer. This literature is subject to all applicable copyright laws and is not for resale in any manner.

# Mouser Electronics

Authorized Distributor

Click to View Pricing, Inventory, Delivery & Lifecycle Information:

[onsemi:](#)

[STK672-400B-E](#)