

# Bipolar Transistor

50 V, 15 A, Low  $V_{CE(sat)}$ ,  
NPN TO-220F-3SG

## 2SC6082

### Features

- Adoption of MBIT Process
- Low Collector-to-Emitter Saturation Voltage
- Large Current Capacitance
- High-Speed Switching
- This is a Pb-Free Device

### Applications

- High-Speed Switching Applications (Switching Regulator, Driver Circuit)

### Specifications

#### ABSOLUTE MAXIMUM RATINGS (Ta = 25°C)

Symbol	Rating	Condition	Value	Unit
$V_{CBO}$	Collector-to-Base Voltage		60	V
$V_{CES}$	Collector-to-Emitter Voltage		60	V
$V_{CEO}$			50	V
$V_{EBO}$	Emitter-to-Base Voltage		6	V
$I_C$	Collector Current		15	A
$I_{CP}$	Collector Current (Pulse)	$PW \leq 10 \mu s$ , duty cycle $\leq 1\%$	20	A
$I_B$	Base Current		3	A
$P_C$	Collector Dissipation		2	W
		$T_C = 25^\circ C$	23	W
$T_j$	Junction Temperature		150	°C
$T_{stg}$	Storage Temperature		-55 to +150	°C

Stresses exceeding those listed in the Maximum Ratings table may damage the device. If any of these limits are exceeded, device functionality should not be assumed, damage may occur and reliability may be affected.

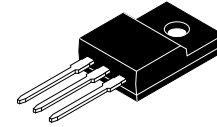

TO-220 Fullpack, 3-Lead /  
TO-220F-3SG  
CASE 221AT

### ELECTRICAL CONNECTION

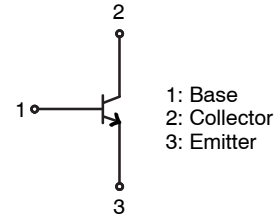

### MARKING DIAGRAM



C6082 = Device Code  
YWW = Date Code (Year & Week)  
ZZ = Assembly Lot

### ORDERING INFORMATION

Device	Package	Shipping
2SC6082-1E	TO-220F (Pb-Free)	50 / Tube

## 2SC6082

### ELECTRICAL CHARACTERISTICS (Ta = 25°C)

Symbol	Parameter	Conditions	Min	Typ	Max	Unit
$I_{CBO}$	Collector Cutoff Current	$V_{CB} = 40\text{ V}, I_E = 0\text{ A}$	–	–	10	$\mu\text{A}$
$I_{EBO}$	Emitter Cutoff Current	$V_{EB} = 4\text{ V}, I_C = 0\text{ A}$	–	–	10	$\mu\text{A}$
$H_{FE1}$	DC Current Gain	$V_{CE} = 2\text{ V}, I_C = 330\text{ mA}$	200	–	560	
$H_{FE2}$		$V_{CE} = 2\text{ V}, I_C = 10\text{ A}$	50	–	–	
$f_T$	Gain-Bandwidth Product	$V_{CE} = 10\text{ V}, I_C = 2\text{ A}$	–	195	–	MHz
$C_{ob}$	Output Capacitance	$V_{CB} = 10\text{ V}, f = 1\text{ MHz}$	–	85	–	pF
$V_{CE(sat)}$	Collector-to-Emitter Saturation Voltage	$I_C = 7.5\text{ mA}, I_B = 375\text{ mA}$	–	200	400	mV
$V_{BE(sat)}$	Base-to-Emitter Saturation Voltage	$I_C = 7.5\text{ mA}, I_B = 375\text{ mA}$	–	–	1.2	V
$V_{(BR)CBO}$	Collector-to-Base Breakdown Voltage	$I_C = 100\text{ }\mu\text{A}, I_E = 0\text{ A}$	60	–	–	V
$V_{(BR)CES}$	Collector-to-Emitter Breakdown Voltage	$I_C = 100\text{ }\mu\text{A}, R_{BE} = 0\text{ }\Omega$	60	–	–	V
$V_{(BR)CEO}$		$I_C = 1\text{ mA}, R_{BE} = \infty$	50	–	–	V
$V_{(BR)EBO}$	Emitter-to-Base Breakdown Voltage	$I_E = 100\text{ }\mu\text{A}, I_C = 0\text{ A}$	5	–	–	V
$t_{on}$	Turn-On Time	See specified Test Circuit		52	–	ns
$t_{stg}$	Storage Time			560	–	ns
$t_f$	Fall Time			37	–	ns

Product parametric performance is indicated in the Electrical Characteristics for the listed test conditions, unless otherwise noted. Product performance may not be indicated by the Electrical Characteristics if operated under different conditions.

### Switching Time Test Circuit

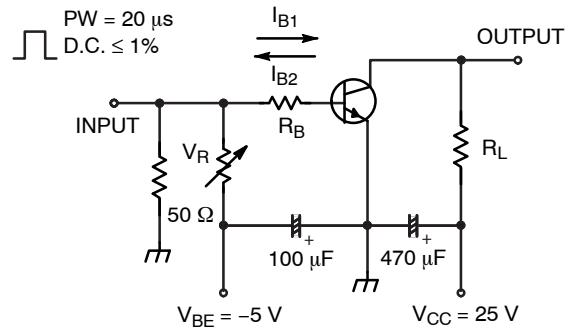

$$I_C = 20I_{B1} = -20I_{B2} = 5\text{ A}$$

**Figure 1. Switching Time Test Circuit**

TYPICAL CHARACTERISTICS

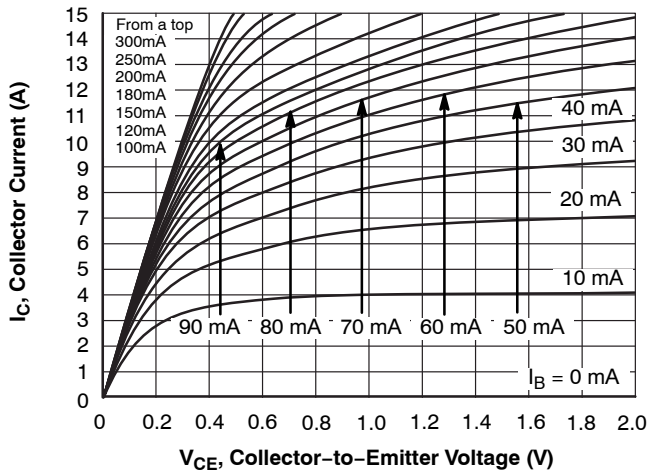

Figure 2.  $I_C - V_{CE}$

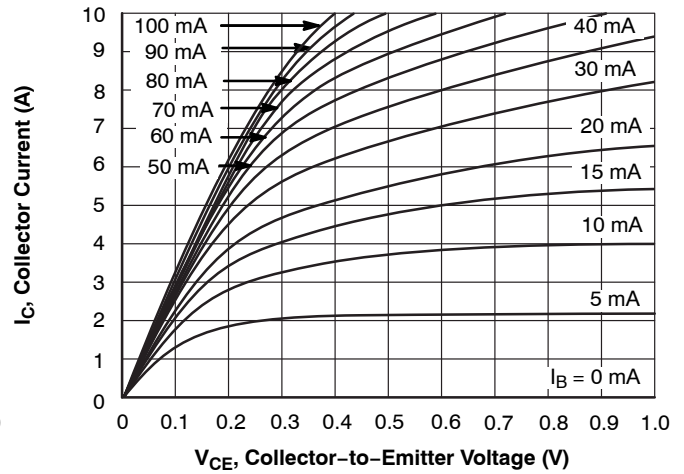

Figure 3.  $I_C - V_{CE}$

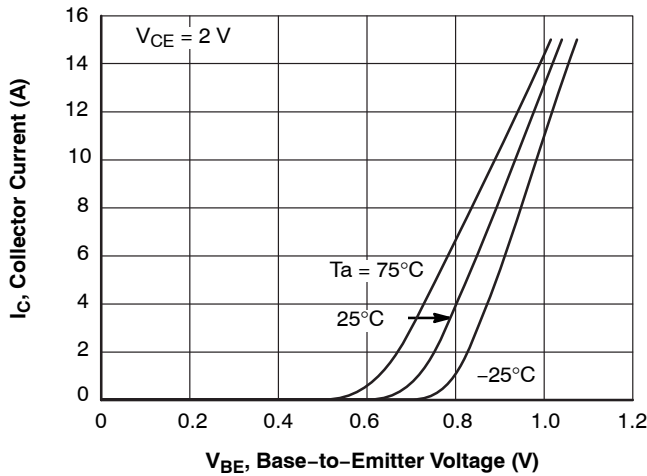

Figure 4.  $I_C - V_{BE}$

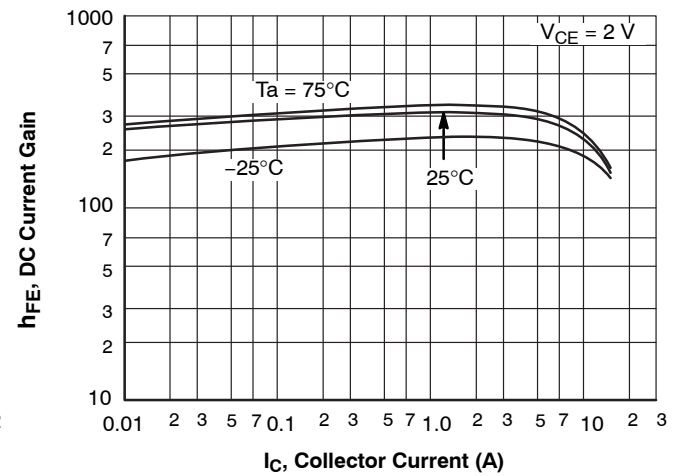

Figure 5.  $h_{FE} - I_C$

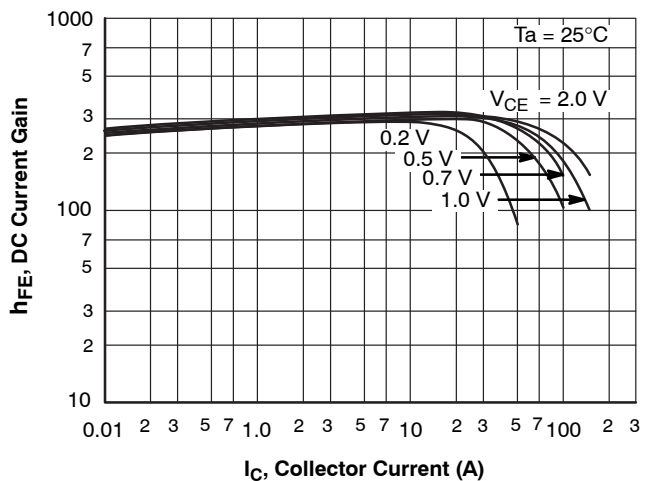

Figure 6.  $h_{FE} - I_C$

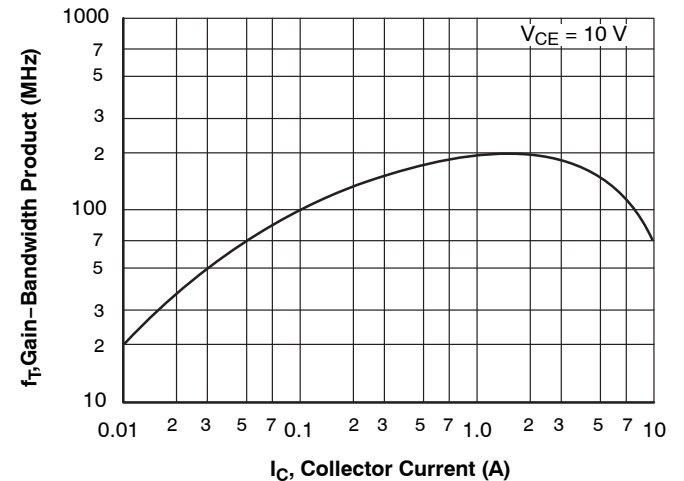

Figure 7.  $F_T - I_C$

TYPICAL CHARACTERISTICS (continued)

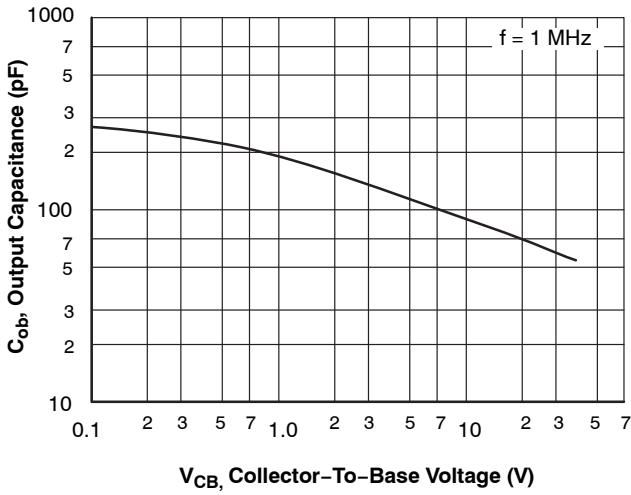

Figure 8.  $C_{ob} - V_{CB}$

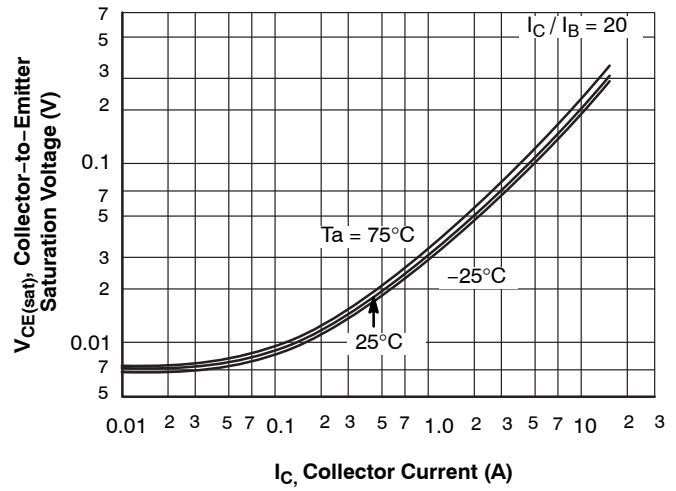

Figure 9.  $V_{CE(sat)} - I_C$

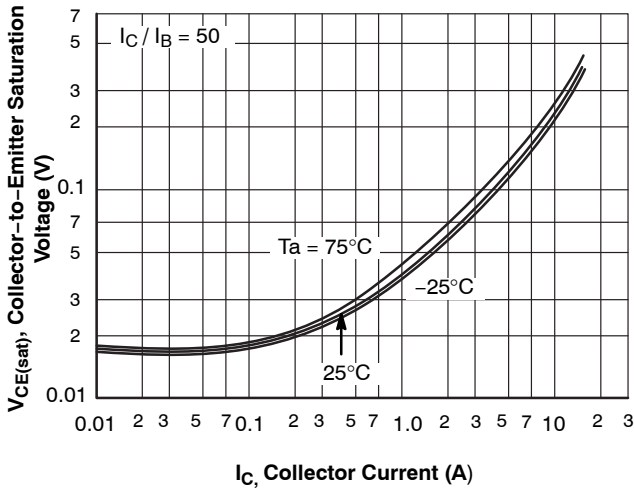

Figure 10.  $V_{CE(sat)} - I_C$

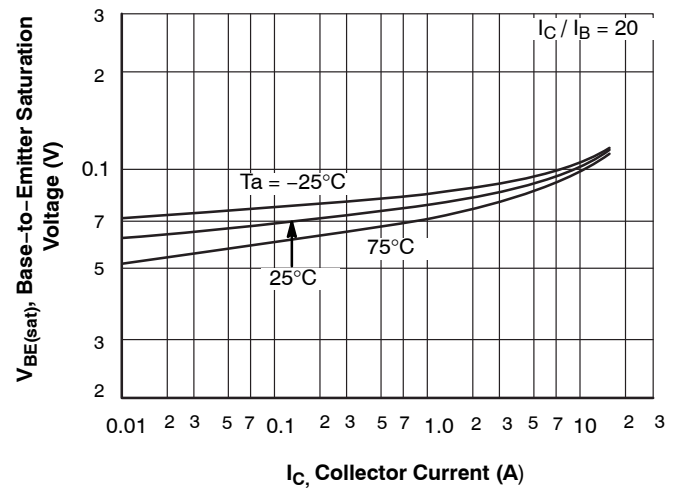

Figure 11.  $V_{BE(sat)} - I_C$

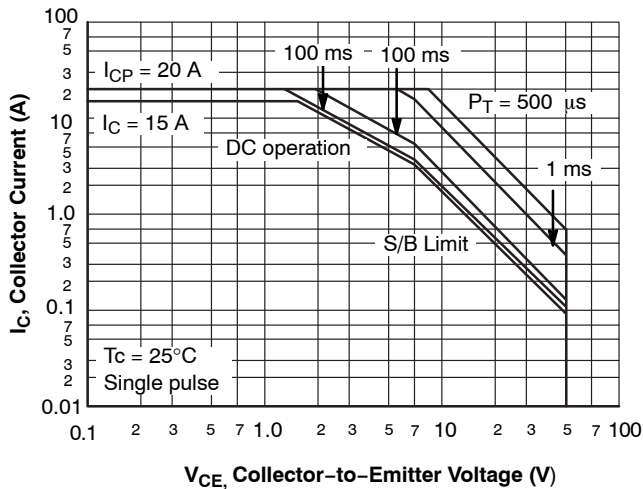

Figure 12. Forward Bias ASO

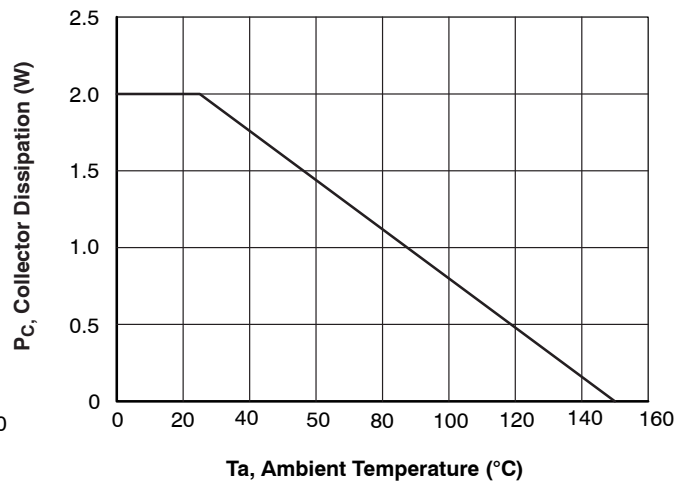

Figure 13.  $P_C - T_a$

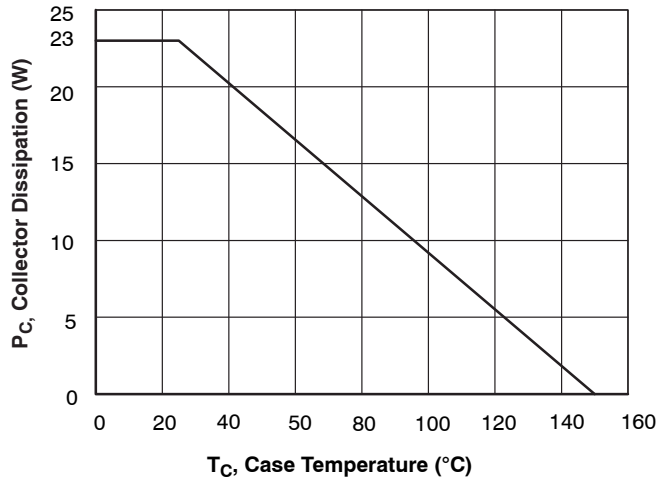
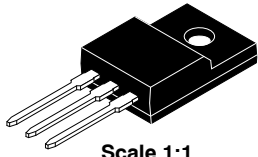

Figure 14. P<sub>C</sub> - T<sub>C</sub>

**TO-220 Fullpack, 3-Lead / TO-220F-3SG**  
**CASE 221AT**  
**ISSUE B**

DATE 19 JAN 2021



Scale 1:1

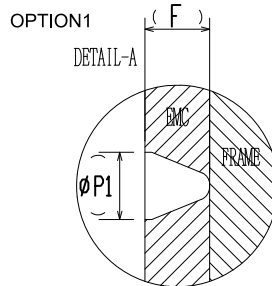
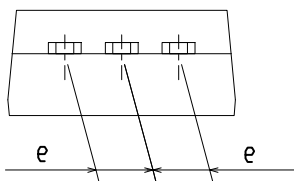
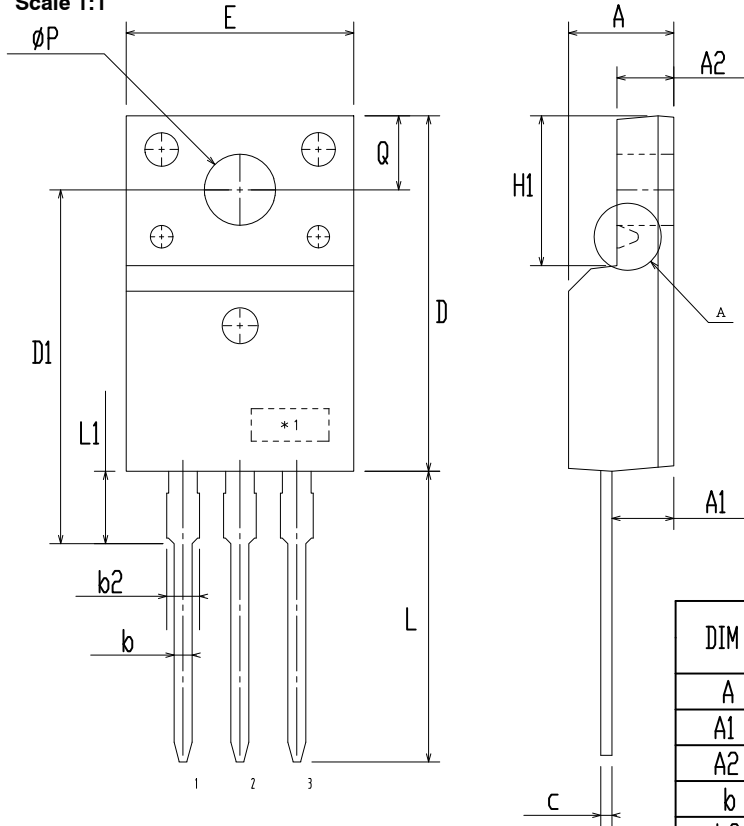

DIM	MILLIMETERS		
	MIN	NOM	MAX
A	4.50	4.70	4.90
A1	2.56	2.76	2.96
A2	2.34	2.54	2.74
b	0.70	0.80	0.90
b2	~	~	1.47
c	0.45	0.50	0.60
D	15.67	15.87	16.07
D1	15.60	15.80	16.00
E	9.96	10.16	10.36
e	2.34	2.54	2.74
F	~	0.84	~
H1	6.48	6.68	6.88
L	12.78	12.98	13.18
L1	3.03	3.23	3.43
∅ P	2.98	3.18	3.38
∅ P1	~	1.00	~
Q	3.20	3.30	3.40

**NOTES:**

- A. DIMENSION AND TOLERANCE AS ASME Y14.5-2009
- B. DIMENSIONS ARE EXCLUSIVE OF BURRS, MOLD FLASH AND TIE BAR PROTRUCTIONS.
- C. OPTION 1 - WITH SUPPORT PIN HOLE
- OPTION 2 - NO SUPPORT PIN HOLE

<b>DOCUMENT NUMBER:</b>	<b>98AON67439E</b>	Electronic versions are uncontrolled except when accessed directly from the Document Repository. Printed versions are uncontrolled except when stamped "CONTROLLED COPY" in red.
<b>DESCRIPTION:</b>	<b>TO-220 FULLPACK, 3-LEAD / TO-220F-3SG</b>	<b>PAGE 1 OF 1</b>

onsemi and ONSEMI are trademarks of Semiconductor Components Industries, LLC dba onsemi or its subsidiaries in the United States and/or other countries. onsemi reserves the right to make changes without further notice to any products herein. onsemi makes no warranty, representation or guarantee regarding the suitability of its products for any particular purpose, nor does onsemi assume any liability arising out of the application or use of any product or circuit, and specifically disclaims any and all liability, including without limitation special, consequential or incidental damages. onsemi does not convey any license under its patent rights nor the rights of others.

**onsemi**, **Onsemi**, and other names, marks, and brands are registered and/or common law trademarks of Semiconductor Components Industries, LLC dba "**onsemi**" or its affiliates and/or subsidiaries in the United States and/or other countries. **onsemi** owns the rights to a number of patents, trademarks, copyrights, trade secrets, and other intellectual property. A listing of **onsemi**'s product/patent coverage may be accessed at [www.onsemi.com/site/pdf/Patent-Marking.pdf](http://www.onsemi.com/site/pdf/Patent-Marking.pdf). **onsemi** reserves the right to make changes at any time to any products or information herein, without notice. The information herein is provided "as-is" and **onsemi** makes no warranty, representation or guarantee regarding the accuracy of the information, product features, availability, functionality, or suitability of its products for any particular purpose, nor does **onsemi** assume any liability arising out of the application or use of any product or circuit, and specifically disclaims any and all liability, including without limitation special, consequential or incidental damages. Buyer is responsible for its products and applications using **onsemi** products, including compliance with all laws, regulations and safety requirements or standards, regardless of any support or applications information provided by **onsemi**. "Typical" parameters which may be provided in **onsemi** data sheets and/or specifications can and do vary in different applications and actual performance may vary over time. All operating parameters, including "Typicals" must be validated for each customer application by customer's technical experts. **onsemi** does not convey any license under any of its intellectual property rights nor the rights of others. **onsemi** products are not designed, intended, or authorized for use as a critical component in life support systems or any FDA Class 3 medical devices or medical devices with a same or similar classification in a foreign jurisdiction or any devices intended for implantation in the human body. Should Buyer purchase or use **onsemi** products for any such unintended or unauthorized application, Buyer shall indemnify and hold **onsemi** and its officers, employees, subsidiaries, affiliates, and distributors harmless against all claims, costs, damages, and expenses, and reasonable attorney fees arising out of, directly or indirectly, any claim of personal injury or death associated with such unintended or unauthorized use, even if such claim alleges that **onsemi** was negligent regarding the design or manufacture of the part. **onsemi** is an Equal Opportunity/Affirmative Action Employer. This literature is subject to all applicable copyright laws and is not for resale in any manner.

## ADDITIONAL INFORMATION

### TECHNICAL PUBLICATIONS:

Technical Library: [www.onsemi.com/design/resources/technical-documentation](http://www.onsemi.com/design/resources/technical-documentation)  
onsemi Website: [www.onsemi.com](http://www.onsemi.com)

### ONLINE SUPPORT: [www.onsemi.com/support](http://www.onsemi.com/support)

For additional information, please contact your local Sales Representative at [www.onsemi.com/support/sales](http://www.onsemi.com/support/sales)

# Mouser Electronics

Authorized Distributor

Click to View Pricing, Inventory, Delivery & Lifecycle Information:

[onsemi:](#)

[2SC6082-1E](#)